



Manual on effluent treatment in aquaculture: Science and Practice

www.aquaetreat.org

Aquaetreat -Improvement and Innovation of Aquaculture Effluent Treatment Technology

Aquaetreat has been achieved with the support of the EU, under the Horizontal Research Activities involving SMEs (Collective Research) scheme (Contract N. COLL-CT-2003-5003 05). Information contained in this book does not reflect its views and in no way anticipates the Commission's future policy in this area.

*This Manual has been printed on recycled paper



Table of Contents

Foreword	5
Conventions and Notation	7
Acknowledgements	11
1 Legislative Context	13
2 Effluent Water Treatment: General	25
3 Effluent Water Treatment: Solids Removal	31
4 Effluent Water Treatment: Algal Ponds	45
5 Effluent Water Treatment: Constructed Wetlands	53
6 Case Study: Hojhoy	67
7 Case Study: Maribrin	91
8 Case Study: Murgat	105
9 IBGN Study: Murgat	123
10 Sludge: Valuable Resource or Disposal Problem	131
11 Cost Analyses	143
12 Future developments and trends	149
Annex: Glossary of terms	151
Annex: Contact points for information	159
Annex: Project Partners	161

Foreword

There is increasing demand by citizens and environmental organisations for unpolluted waters in rivers, lakes, groundwater and sea. When asked by the opinion poll (Eurobarometer) to list the five main environmental issues that Europeans are worried about, averaged results for the EU25 show that nearly half of the respondents are worried about “water pollution” (47%), with figures for some countries as high as 71%.

This is why the European Commission has made water protection one of the priorities of its work.

Intensive farming uses significant inputs to maximise production. In aquaculture, the accumulated by-products (e.g. fish faeces, excretions, uneaten feed) must be removed continuously to maintain health and welfare of the fish and to achieve optimal growth. Suspended solids and dissolved nutrients in the effluents have potential negative impacts on the environment. The amount of these materials in the effluent depends on a wide range of factors. Their environmental impact can be decreased either by improved farm management, or by physical and/or biological treatment of the effluent.

The collective research project AQUAETREAT - Improvement and innovation of AQUAculture Effluent TREATment Technology, has been funded by the European Commission within the 6th Framework Programme. It aims to improve the management of effluent from farming processes.

Modern intensive land-based aquaculture systems can be divided in two types: open and closed systems. In open systems, water used to rear fish, from whatever source, is discharged to the environment with its content of solids and nutrients, after passing through the farm. In closed systems, at least part of the water is recycled after specific treatments to reduce the content of solids and dissolved nutrients.

In this context, intensive aquaculture needs efficient, reliable, easy to implement and economically affordable systems to increase the efficiency of water use. Development and implementation of innovative methods and technologies for farm effluent water treatment, water reuse and by-products recycling will reduce the quantity of clean water used in fish farming and the amount of materials discharged to the environment.

This manual describes the results from the 3-year project in the research of reliable methods to achieve these objectives, and gives a comprehensive overview on how the problem of water use and effluent management has been approached in three different case studies.

The manual is intended to be a practical tool for land-based aquaculture in the implementation of water treatment technology to improve their environmental efficiency and credentials. Transformation of by-products with potential as fertiliser with value to agriculture is discussed.

The goal of this Manual is to raise awareness in aquaculture of the technology available to make future aquaculture cleaner, safer and better.

S. Vilella

Conventions and notation used in the manual

J. Claricoates

Units

Where possible and appropriate, the manual adopts the International System of Units (SI units; Le Système International d'Unités). This is the world's most widely used system for science and for everyday commerce. It uses the kilogram (kg), metre (m) and second (s) as its base units, with other units being derived from these. Its adoption enables values to be easily converted and accurately compared. This level of accuracy and precision is often required when considering the scientific basis of management decisions.

The manual is aimed at sound practical management and therefore, in some places, more familiar, non-SI, units have been retained. This is so where a) the SI equivalent cannot be accurately calculated, b) the non-SI unit is familiar to readers and it is not necessary for reasons of accuracy or precision to convert the original units used or c) the SI unit is unnecessarily complex.

Readers will be familiar with a range of different units. Table 1 contains conversions that may therefore be helpful.

Number notation

For decimal numbers and for currency, a full-stop (.) is used to separate the fractional part of the number from its integer (for example, 100.25 and €100.25). A comma is used to separate third-orders of magnitude (such as thousands: 1,000.25 and €1,000.25).

Chemical notation

In a manual addressing environmental management of aquatic systems and its scientific basis, it is necessary to employ some chemical notation. This has been kept to a minimum. It is recognised that readers will have different levels of familiarity with water science, and the following is included to assist interpretation of any unfamiliar technical notation used. It may be helpful to read it in conjunction with the Glossary (see table 2).

Table 1: Conventions used in the manual

	SI Unit	Apply this conversion	to express the value in this equivalent Unit
<i>Weight</i>			
kilogram	kg	kg x 1,000	g, gram
tonne	T (= kg x 1000)	kg / 1,000	T, tonne (or ton)
milligram	mg (= kg / 1,000,000)		
<i>Length</i>			
metre	m	m x 1,000,000	µm, micron
<i>Volume</i>			
litre	l or L	l / 1,000	m ³
millilitre	ml (= l / 1,000)		
<i>Flow rate</i>			
litres per second	l/s	(l/s) x 3.6	m ³ /h
<i>Concentration</i>			
milligrams per litre	mg/l	(mg/l) / 10,000	%
		(mg/l) / 1	ppm
grams per litre	g/l	(g/l) / 10	%
		(g/l) / 1	‰
		(g/l) / 1,000	ppm
milligrams per kilogram	mg/kg	(mg/kg) / 10,000	%
		(mg/kg) / 1	ppm
grams per kilogram	g/kg	(g/kg) / 10	%
		(g/kg) / 1,000	ppm
<i>Pressure</i>			
Pascal	Pa	100,000 / Pa	bar
<i>Time</i>			
seconds	s		
	/s	(1 / s) x 3,600	/h (per hour)
	/s	(1 / s) x 86,400	/d (per day)

Table 2: Conventions used in the manual

Symbol	Read as	Comment
BOD ₅	'biological oxygen demand' or 'biochemical oxygen demand'	See Glossary
C	'carbon'	
d	'day'	
dw	'dry weight'	See Glossary
fw	'fresh weight'	See Glossary
K ₂ O	'potassium monoxide'	
mM	'milliMole'	A chemical unit of concentration
N	'nitrogen'	An element, existing predominantly in compounds with other elements, such as oxygen and hydrogen, in the environmental systems with which this manual is concerned.
NH ₃	'ammonia', or 'non-ionised ammonia'	Inorganic nitrogen compound
NH ₃ -N	'nitrogen as ammonia'	The amount of nitrogen present in the form NH ₃
NH ₄	'ionised ammonia' or 'ammonium'	Inorganic nitrogen compound. More accurately written NH ₄ ⁺
NH ₄ -N	'nitrogen as ionised ammonia / ammonium'	The amount of nitrogen present in the form NH ₄
NO ₂	'nitrite'	Inorganic nitrogen compound. More accurately written NO ₂ ⁻
NO ₂ -N	'nitrogen as nitrite'	The amount of nitrogen present in the form NO ₂ .
NO ₃	'nitrate'	Inorganic nitrogen compound. More accurately written NO ₃ ⁻
NO ₃ -N	'nitrogen as nitrate'	The amount of nitrogen present in the form NO ₃ .
TAN	'total ammonia nitrate'	The total amount of nitrogen present in the NH ₃ and NH ₄ forms.
TN, Total N	'total nitrogen'	The total amount of nitrogen present.
P	'phosphorous'	
PAH	'Polycyclic Aromatic Hydrocarbons'	
PCB	'Polychlorinated Biphenyl'	
PO ₄	'phosphate'	More accurately written PO ₄ ³⁻
PO ₄ -P	'phosphorous as phosphate'	The amount of phosphorous present as phosphate.
rpm	'revolutions per minute'	
TP, Total P	'total phosphorous'	The total amount of phosphorous present.
Urea-N	'urea nitrogen'	The amount of nitrogen present as urea.

Acknowledgements

AQUAETREAT – (Improvement and Innovation of Aquaculture Effluent Treatment Technology) has been achieved with the support of the EU, under the Horizontal Research Activities involving SMEs (Collective Research) scheme.

The Federation of European Aquaculture Producers (FEAP) is the European Industrial Association on behalf of which the Research Institutions have performed the project's scientific and technological research activities.

Three intensive aquaculture farms were directly involved in the project activity. These are Maribrin (Italy), producing Sea Bream and Sea Bass in a seawater flow-through system; Murgat (France), affiliated with the Comité Interprofessionnel des Produits de l'Aquaculture, producing trout in a freshwater flow-through system and Højhøy (Denmark) producing trout in a freshwater recirculation system. An engineering and commercial company (STM aquatrade, Italy), completed the core group of SMEs.

The University of Lecce (now University of Salento, Italy), represented by Sebastiano Vilella, acted as the Co-ordinator of the project. Other RTD performers included Ifremer, the largest research institute in marine biology in France, the Aquaculture Wales and Complex Fluids Engineering research Groups, located at Swansea University, Wales (UK) and the Institute of Grassland and Environmental Research (UK).

This manual on aquaculture effluent treatment has been written based on the experience of farmers, companies and research institutes working together in the sector and is one of the main outputs of the AQUAETREAT project. The manual has been prepared by the authors under the co-ordination of Nick Read (FEAP) and Jane Claricoates (Swansea University). The design, layout and preparation of the manual for printing was made by Margreet van Vilsteren (FEAP).

The close collaboration of the three fish farms, where the research and tests were done, has been essential to obtain the results that are now made widely available in this manual.

We would like to thank the handbook co-ordinators and the individuals responsible for the work done in the fish farms:

- Maribrin S.r.l.: Licinio and Federico Corbari
- Murgat: Laurent and Vincent Murgat
- Højhøy: Aquapri, Anders Anderson and Gitte Nielsen

Last, but not least, we would like to thank Vincenzo Zonno and Raffaele Acierno, from University of Salento, Italy (formerly University of Lecce), for project co-ordination and Consortium management during these three years.

1. Legislative context

J. Claricoates

1. Introduction

No one can be involved in aquaculture for very long without becoming aware of the extensive array of legislation within which the industry operates in Europe¹. At the farm level, it may sometimes feel as if the legislation is a brake on development at a time when aquaculture is regularly proclaimed as the fastest-growing food sector in the world. Are aquaculture producers in Europe to be disadvantaged in playing their part in the development of the industry, and from enjoying their share of the prizes? This would be of no benefit, and seems unlikely as a policy goal. Why would policy and its organising legislative framework conspire to disadvantage Europe in this regard? Yet at the operational level, the legislative net seems to tighten, and the associated costs of compliance to rise, in a sector where margins are already hard to maintain.

The AQUAETREAT project was conceived in part as a response to such strengthening environmental legislation, at a time when its current and future impact on aquaculture was becoming increasingly apparent. How to reposition production operations to comply with more stringent environmental requirements, at the same time as achieving the improvements in efficiency necessary to remain viable?

Legislation is not the only force shaping the industry.

Technological development is playing a critical role in mediating the twin goals of increasing efficiency and compliance. Later chapters focus on technological aspects of development.

The current chapter provides a brief account of some important aspects of the wider legislative landscape in which aquaculture producers must operate, and sets out some relevant major trends in European policy. With a larger



Picture 1: flags
(photo European Union 2007)

picture in mind, the legislative and technological advances currently shaping the industry can more clearly be understood as complementary, indeed mutually supportive, processes.

A short chapter on such a complex topic cannot be comprehensive. However, it can assist with a more coherent perspective, based on recognition of the need

simultaneously to develop complementary legislation and technology when seeking sustainability for the industry. Both offer opportunities and constraints; both are evolving. Increasingly, their respective goals are becoming aligned. This chapter aims to contribute to that alignment. More specifically, it aims

- to assist producers in gaining a more effective understanding of the general direction of environmental policy development;
- to suggest sources for further reading and so assist producers to maintain an accurate and up to date knowledge of environmental policy and implementation development;
- to support producers at all levels of operation to engage directly or indirectly with current debates for the development of appropriate legislative frameworks to which the industry is – and will be – bound;
- to support producers in making effective submissions for the targeted interventions that will be required (for example under the European Fisheries Fund) to enable them to maintain competitive status while undergoing necessary shifts in practice.

The engagement of all stakeholders in a range of structural and technological developments continues to be essential if sustainability is the goal for individual producers and the industry.

2. Scope

Whilst many different aspects of aquaculture are regulated, the focus of the AQUAETREAT project is on the environmental impact of farms and on technical approaches to its reduction: how can producers improve their farm's efficiency at the same time as minimising its environmental impact? There are two major areas of relevant legislation, dealing with protection of the quantity and quality of the water resource and with the management of effluent.

3. Environmental Policy trends

At the European level there are two simultaneous policy trends in evidence currently. The first is a move towards broader, integrated, thematic legal frameworks; the second is an increasing requirement for precision in implementation, enabled by developments in scientific and technological capacity. This section describes generic development trends in European environmental and waste frameworks. Later sections focus on three examples with some relevance to aquaculture production: the Water Framework Directive, the Waste Framework Directive and the Environmental Liability Directive, setting out their relevance and current state of development.

Because aquaculture producers use a shared primary resource (water) and because their operations generate materials (effluents) that return to a public domain, producers find themselves the subject of a significant amount of the legislation aimed at protecting the common good. Such protection is an

essential requirement of a sustainable condition, especially in connection with an activity that depends on one or more shared primary resources.

In the different Member States of Europe different mechanisms exist to protect the environment and to manage waste. This variability is inherent in the European legal framework and will continue. At the same time, Europe aspires to an important goal to act according to common rules, formulated and agreed by all parties. Such an aspiration is a demanding endeavour and requires continual attention.

There are three levels at which development of legal frameworks in Europe is underway, all of which impact daily on aquaculture production operations. First, Member States continue to develop their own national legislation in response to national needs. Second, Europe is developing Community-wide legislation in those areas where a common need is perceived. There are different types of European law, of which Directives are the most relevant here. They set out the goals of the legislation and Member States are free to make their own legal arrangements for implementation to achieve the goals. Timetables are imposed. Member States may decide to introduce new national legislation to implement the whole of the Directive, or they may decide that their existing national legislation already achieves the goals and so no new legislation is necessary. Commonly, Member States use the arrival of a Directive to review and revise that component of their existing frameworks, and to 'tidy up' a complex array of historical and often fragmented arrangements. This provides a useful opportunity to update national legal frameworks to align them more closely with social and economic trends. It also, therefore, represents a point in the process closest to individual producers, when their active involvement in formulating national frameworks can assist in achieving practicable outcomes. Trade and professional associations may be more readily positioned to contribute to policy development at the European level. The connection between the two – active and informed memberships – is therefore critical to the achievement of informed, workable frameworks.

The environment was an early focus for Community legislation. As a consequence, there is now a complex collection of many complementary measures for protecting biodiversity, resources, landscapes, human health and so on. More recently, a third level of European legal activity has begun. This is the formulation of so-called 'Framework Directives', which co-ordinate a broad theme (Water, Waste, for example) and aim to consolidate by means of the Framework the objectives of many relevant strands of existing legal provision. Again, this provides a significant opportunity to modernise the aspirational common legal framework across Europe while at the same time allowing for national variability in implementation mechanisms. Commonality of goals, standards and accessibility to resources facilitates the sustainable development of the industry. At the same time, the retained flexibility at national level requires producers to familiarise themselves with the obligations, mechanisms and competent authorities (See Glossary) of their own Member State.

The Water Framework Directive is an essential component of Europe's environmental (primary resource) protection policy. It also provides a first example of the generic Framework-development process and its direct relevance to aquaculture producers.

4. The Water Framework Directive

The Water Framework Directive (WwFD^{2*}) (Directive 2000/60/EC establishing a framework for Community action in the field of water policy) entered into force in December 2000³. It encompasses, consolidates and develops the provisions within several earlier Directives (on surface waters, information exchange on freshwater quality, fish water, shellfish water, groundwater and dangerous substances discharge), which are replaced by the WwFD. Some other associated Directives remain in place, such as the Nitrates Directive. An important streamlining aim of the WwFD is to co-ordinate the application of extant environmental objectives in such a way as to meet the integrated objectives of the WwFD ('good' status for all waters). The natural hydrologic unit of the river basin has been adopted as the fundamental organisational and monitoring unit of the WwFD.

The WwFD thus aims to establish a framework for protection of waters in order to:

- prevent further deterioration, and to protect and enhance the condition of aquatic ecosystems and wetlands
- promote sustainable water use
- enhance protection and improvement of the aquatic environment, including the progressive reduction of discharges and the cessation of certain hazardous substances
- ensure reduction of pollution of groundwater and prevent further pollution.

The WwFD applies to natural, artificial or heavily modified waters and applies to the waters and activities listed in Table 1.

Table 1: Waters and activities to which the Water Framework Directive applies

Waters	Activities
<ul style="list-style-type: none"> • Surface • Groundwater • Inland (standing, flowing, groundwater) • Brackish • Coastal 	<ul style="list-style-type: none"> • Abstraction of surface or groundwater • Impoundment of surface or groundwater • Storage of surface or groundwater • Treatment of surface or groundwater • Distribution of surface or groundwater • Wastewater collection and treatment • Any other activity

*WFD is the usual acronym used for both the Water and the Waste Framework Directives. In order to distinguish between the two here, WwFD and WsRD are used, respectively

The implications are clear for aquaculture producers whose farms are based on land or in coastal waters, working with freshwater or marine species.

Under the terms of the WwFD, quantitative information regarding the ecological and chemical status (relative quality) of the water, aquatic ecosystem or wetland is required. The determination of ecological status is based on those parameters that describe the quality of the structure and functioning of aquatic ecosystems associated with surface waters; biological, hydromorphological and physico-chemical characteristics must be characterised. A standard list of criteria for each water type is included in the Directive. A selection of the criteria for determining the ecological status of fresh-, brackish and coastal waters is shown in Table 2.

Table 2: Selected criteria to be used in determining the ecological status of certain waters under the Water Framework Directive

	Rivers	Lakes	Brackish	Coastal
Phytoplankton		•	•	•
Other aquatic flora	•	•	•	•
Benthic invertebrates	•	•	•	•
Fish fauna	•	•	•	
Continuity	•			
Hydrology	•	•	•	
Tidal regime			•	•
Morphological conditions	•	•	•	•
Thermal conditions	•	•	•	•
General physico-chemical conditions	•	•	•	•
Oxygenation	•	•	•	•
Salinity	•	•	•	•
Nutrient status	•	•	•	•
Acidification status	•	•		
Specific synthetic pollutants	•	•	•	•
Specific non-synthetic pollutants	•	•	•	•
Other pollutants	•	•	•	•

Surface waters are assigned a status according to the poorer of their ecological (('maximum'), 'high', 'good', 'moderate', 'poor' or 'bad') and chemical (('maximum'), 'high', 'good', or 'moderate') status. Groundwater is assigned a status according to the poorer of its quantitative ('good') and chemical status ('good' or 'poor'). It would be in contravention of the Directive to cause deterioration in the ecological status of, for example, a recipient aquatic ecosystem.

Under the Directive, the determination of chemical status applies to surface waters, sediments and their biota. Parameters listed in the Directive as contributing to chemical status include

- organophosphates
- mutagens
- persistent and bioaccumulable organic toxic substances
- metals and their compounds
- arsenic and its compounds
- biocides
- materials in suspension
- substances that contribute to eutrophication
- substances that have an unfavourable effect on oxygen balance.

The list highlights a need for compliant management of chemical status of the surface waters, sediments and biota associated with aquaculture production, where the WtFD applies.

Under the Directive, groundwater is assessed in terms of its quantitative and chemical characteristics. A number of core parameters are specified, including

- oxygen content
- pH
- conductivity
- nitrate
- ammonium
- any parameters indicative of the impact of detrimental natural processes or anthropogenic activities

A certain amount of discretion is allowed to Member States to decide precisely what parameters are significant and must be measured. Some may choose to retain this discretionary element in their transposition of the Directive into national law, while others may seek to be more definitive. Hence, it is likely that Member States will vary in what they deem to be the necessary metrics beyond those core parameters listed in the Directive.

Member States are currently deciding the absolute thresholds of each parameter that define – for their country – the different statuses on which implementation of the WtFD is based. This is a highly complex process which must incorporate in a meaningful manner the reality and significance

of natural variation in a system's ecological structure and function. It is only one of many tasks involved in achieving full implementation; the WwFD has spawned a number of related, so-called 'Daughter Directives' in the process of preparing for full implementation, many of which are very accessible primary information sources⁴. An idea of the nature and complexity of this task, and of other aspects of national preparations, may be gained by visiting the website of the UK's Technical Advisory Group on the WwFD⁵. Finally, the WwFD explicitly recognises the need to achieve parity of ecological assessment across Europe. A so-called 'inter-calibration exercise' is currently underway to achieve this, involving 1500 sites⁶.

Ultimate responsibility for compliance rests at the Member State level. The degree of responsibility at the farm level will depend upon compliance arrangements established by each competent authority⁷. Establishment of national monitoring networks were due to be completed by December 2006; river basin management plans are due to be completed by 2009 and to be operational by 2012. Environmental objectives under the Directive must be met by 2015. Notwithstanding differences in detailed implementation, across Europe actions

that result in a contravention of the Directive will be disallowed. Hence it makes sense to improve the management of farm water and effluent to achieve the best environmental quality possible, in order to approach compliance in a systematic way that is within a manager's control and best fits existing farm practices and goals. Compliance is likely to reap economic benefits as well as the environmental ones, and at the very least will avoid sanctions imposed for non-compliance.



Picture 2: lagoon (photo STM aquatrade)

5. The Waste Framework Directive

It is currently far from clear whether, and if so how and to what extent, the Waste Framework Directive (WwFD)⁸ will affect aquaculture production. It is the most recent Framework Directive with potential direct relevance to the industry, having come into force on 27 April 2006. Two important matters require resolution, specifically in relation to aquaculture. The first is to clarify aspects of the definition of "waste", to determine whether or not aquaculture effluent is included. Second, certain delineations may need to be determined between the WwFD and the WwFD; both encompass aspects of pollution control which potentially apply to land-based aquaculture.

However, many would seem already to be encompassed within the WrFD or other legislation (for example, suspended solids).

Whilst the direct relevance of the WrFD to aquaculture production is immediately clear, it is too early for the precise implications of the WsFD to be so well understood. Notwithstanding this uncertainty, a brief consideration of aspects of the WrFD's objectives and their environmental significance informs an understanding of the broader trends in European environmental legislation.

The WsFD is positioned in an evolving EU policy area. The EC 'Thematic Strategy on the prevention and recycling of waste'⁹ sets out a number of actions that will be required to advance the goals of waste prevention, recycling and re-use. It aspires to create new opportunities for waste management - away from landfill. This suggests an omission of consideration of aquaculture, which itself implies recognition of the insignificance of aquaculture effluent in the 'waste' context as currently defined and focused.

The WsFD consolidates the objectives of the much-amended original Waste Directive (1975)¹⁰, now repealed. It states that "The essential objective of ... waste management should be the protection of human health and the environment against harmful effects caused by the collection, transport, treatment, storage and tipping of waste" and that "the recovery of waste and the use of recovered materials as raw materials should be encouraged in order to conserve natural resources".

The WsFD recognises the importance of common terminology and a definition of waste in achieving efficient waste management across Europe. A critical question to be resolved for aquaculture effluent is the precise definition of waste: when is 'waste' to be considered, instead, as a resource for a subsequent process? A recent 13-page EC Communication addresses this specific question, recognising that "The definition of waste has been a key part of protecting the European environment ... over the past thirty years"¹¹. The Communication aims to explain the definition of waste as provided in Article 1 of the WsFD: "any substance or object in the categories set out in Annex I which the holder discards or intends or is required to discard." Annex I includes a final 'catch-all': "Any materials, substances or products which are not contained in the abovementioned [15] categories".

This clearly suggests that aquaculture effluent will be subject to the WsFD. But the situation is not so straightforward. As noted in the Communication referred to above, "In EU law, notions such as by-product or secondary raw material have no meaning – materials are simply waste or not." The Communication includes a rationale for the need for more clarity on certain aspects of the definition. It gives a series of legal-case and other examples that test the current definition and thereby begin the necessary process of refining 'waste' law and its application.

None of the case studies refers to aquaculture but the Communication proposes guidelines for deciding if a material is a waste or not and, if not, distinguishes between materials that it describes as follows:

- Product – all material that is deliberately created in a production process. In many cases it is possible to identify one (or more) “primary” products, which is the principal material produced.
- Production residue – a material that is not deliberately produced in a production process but may or may not be a waste.
- By-product – a production residue that is not a waste.

A decision tree for distinguishing between the proposed material designations is provided at Appendix II of the Communication. The guidelines will be reviewed in 2010.

The question of whether aquaculture effluent is a waste or a valuable resource is addressed scientifically and practically in another chapter of this Manual; the valorisation of farm sludge through its reuse is assessed. Ideally, the aims of a sustainable industry would include the obsolescence of waste to the fullest extent possible. To quote the EC ‘Thematic Strategy on the prevention and recycling of waste’¹², “The long-term goal is for the EU to become a recycling society that seeks to avoid waste and uses waste as a resource”. ‘Waste’ implies the unproductive use of resources, a situation which the highly competitive aquaculture market acts against. Economically feasible developments, most often technological, that can reduce ‘waste’ are keenly sought by the industry. The management of ‘waste’ – its collection, handling, storage and disposal represents a real cost. It would be counterproductive in all respects to designate material that is to be recycled or reused as a ‘waste’. Untreated aquaculture effluent, appropriately treated, has a range of potential which has yet to be fully investigated. At least some of this potential is directly in line with current policy guidance, including composting and energy recovery. In its raw state it is, furthermore, mostly water, itself a critical primary resource and a limiting factor for aquaculture development generally. It seems difficult to conceive of such a material as a ‘waste’. Indeed, can such a notion be reconciled with water protection measures being applied across Europe and globally? It must surely be more appropriate and sustainable to interpret ‘waste’ in relation to aquaculture effluent in such a way as to encourage and facilitate its further processing and recycling or reuse.

To view a reusable material as ‘waste’ is considered a retrograde step when compared against the more enlightened approach to waste management being developed for Europe, the stated objectives of which are to “prevent waste and promote re-use, recycling and recovery so as to reduce the negative environmental impact”. This broad approach also makes for leaner business. The drive to develop a sustainable aquaculture industry could, potentially, be well served by the WsFD, given a compatible definition of ‘waste’. It is therefore to be hoped that a practical approach will be applied to the refinement of the definition and interpretation of ‘waste’.

6. The Environmental Liability Directive

The Environmental Liability Directive 2004¹³ has had considerably less exposure than the WtFD, despite its far-reaching implications for any land user. Member States were required to put in place provisions for the Directive by April 2007. It aims to establish a framework of environmental liability, based on ‘polluter pays’ and sustainable development principles, to prevent and remedy environmental damage and to reduce human health risks and loss of biodiversity. Its fundamental principle is that an operator whose activity has caused environmental damage is to be held financially liable. The aim is to induce operators to develop practices that minimise the risks of environmental damage and so reduce their exposure to financial liabilities. Requirements of the Directive also include that operators should ultimately bear the cost of assessing environmental damage and assessing an imminent threat of such damage occurring.

The Directive applies to occupational activities and to environmental impacts, including

- activities that present a risk to human health or the environment
- occupational activities posing an actual or potential risk
- damage to water
- damage to land,
- collection, transport, recovery and disposal of waste
- discharges to surface water, groundwater and the aquatic environment
- water abstraction and impoundment
- the use, storage, processing, filling, release into the environment and onsite transport of biocidal products.

“Damage to water” means any damage that significantly affects the ecological, chemical and / or ecological potential as defined in the WtFD. “Water” refers to all waters covered by the WtFD. “Damage” includes damage to natural resources and / or services.

The Directive requires that where there is an imminent threat of environmental damage the operator must take preventative measures. It further requires effective environmental restoration, where damage occurs, against relevant restoration objectives and according to a defined national framework. Restoration may involve the control, containment, removal or other management of the relevant contaminants and / or other damage factors. The significance of any damage must also be assessed. Damage with a proven effect on human health is always deemed significant under the Directive.

Once again, this recent Directive has a focus on (human and) environmental health, and is broad in scope. It strengthens the WtFD with *assessment* and *financial liability*.

7. Issues concerning suggested re-use or recycling of aquaculture effluent components

Aspects of the highlighted legislation have touched on matters relevant to the re-use or recycling of treated aquaculture effluent. More specific legislation exists that is pertinent in this regard, for example where sludge may be used as a fertiliser, where the fertiliser would be used for crops that will enter the human food chain, or where energy is generated. In developing innovative treatment, recycling, re-use and recovery methods for the components of effluent, it should be expected that other legislation will be encountered and require to be navigated.

8. Conclusions

Compliant environmental management on the farm is not a new concept. What is new is the scope and precision of the obligations placed on Member States, and their formulation within broader, integrated frameworks. Aquaculture is not alone in feeling the impact of this new situation. Compliance will require a systematic and quantitative monitoring approach. In some countries this may be achieved by statutory monitoring programmes as part of standard regulatory practices conducted by competent authorities or their agents. Later chapters in the Manual, however, provide convincing evidence for a more active role for farm managers and associated professionals in the systematic monitoring of water quality on farms, as a basis for optimising systems and developing more sophisticated site management. It is shown how such information feeds into farm management decisions and can achieve significant benefits. The monitoring needed to achieve the level of environmental compliance now required across Europe is also that on which sound innovation, improved productivity and the maintenance of viable margins will depend.

The more integrated and scientifically-informed approaches to environmental legislation seek to readjust some important foundations underpinning earlier arrangements. The boundaries of acceptability in terms of environmental impact are gradually being redrawn, and whilst some of this change will bring with it genuine challenges, the aspirant new order also begins to offer a range of opportunities for innovation, in line with the requirements of long-term sustainability of the industry. Producers are likely to be rewarded by a closer involvement with the developing legislative debates, and by seeking innovative approaches to compliance, increasingly in partnership with research agencies, thus expanding their developmental and funding horizons. Indeed, at this time of legislative renewal and transformation, successful innovation will be welcomed, and can contribute not only to wider compliance, but to the shape of future legislative arrangements, particularly any specific to aquaculture effluent treatment, recycling and re-use which, hitherto, have been relatively weakly developed.

9. References

1. A structural overview of European policies as they relate to aquaculture may be found at www.profetpolicy.info. This chapter focuses specifically on aspects of the environmental context.
2. Directive 2000/60/EC. OJ L 327 22.12.2000, pp1-73. Full text available on EUR-Lex website at <http://eur-lex.europa.eu> (site last accessed 14 October 2007)
3. The implementation timetable for the WwFD can be found at http://ec.europa.eu/environment/water/water-framework/info/timetable_en.htm (Site last accessed 13 October 2007.)
4. For example, see 'Proposal for a Directive of the European Parliament and of the Council on environmental quality standards in the field of water policy and amending Directive 2000/60/EC' (COM(2006)397 Final) on the EUR-Lex website at <http://eur-lex.europa.eu>.
5. www.wfduk.org
6. Action 22002 – European Ecological Water Quality Assessment and Intercalibration (EEWAI). See <http://ies.jrc.cec.eu.int>
7. Links to the official WFD websites of each Member State can be found at http://ec.europa.eu/environment/water/water-framework/links/index_en.htm. (Site last accessed 13 October 2001.)
8. Directive 2006/12/EC of the European Parliament and of the Council of 5 April 2006 on waste (Text with EEA relevance). OJ L 114, 27.4.2006, pp 9-21. See <http://eur-lex.europa.eu>.
9. COM(2005)666 Final. Communication from the Commission to the Council, the European Parliament, the European Economic and Social Committee and the Committee of the Regions. Taking sustainable use of resources forward: A Thematic Strategy on the prevention and recycling of waste. Available on the EUR-Lex website at <http://eur-lex.europa.eu>.
10. Council Directive 75/442/EEC. OJ L 25.7.1975, p 39. See <http://eur-lex.europa.eu>.
11. COM(2007)59. Communication from the Commission to the Council and the European Parliament on the Interpretative Communication on waste and by-products (Text with EEA relevance).
12. COM(2005)666 Final. Communication from the Commission to the Council, the European Parliament, the European Economic and Social Committee and the Committee of the Regions. Taking sustainable use of resources forward: A Thematic Strategy on the prevention and recycling of waste. Available on the EUR-Lex website at <http://eur-lex.europa.eu>.
13. Environmental Liability Directive (2004/35/CE). See <http://eur-lex.europa.eu>.

2. Effluent water treatment: General

N. Read

Aquaculture in Europe is a mainstream supplier of healthy and nutritious food products to consumers. Those consumers have expectations with regard to environmental protection and it follows that these expectations are reflected in policies and legislation from the European Union. The Water Framework Directive is the most direct result and the declared objective of that directive is to ensure that all waters within EU are returned to a 'good' status by 2015.

All users of water will come under close scrutiny as competent authorities in Member States work to achieve this objective. Fish farmers make use of large quantities of water, albeit in a non-consumptive manner. Water is a finite resource and while Europe enjoys abundant supplies of water compared with other parts of the world, competition for use of that water is increasing. To be able to retain the use of large amounts of water for fish farming, the industry must demonstrate a high level of responsibility and efficiency in its use.



Figure 1: A general view of Maribrin's tanks and the filter that is used (Photo STM aquatrade)

Technical progress in aquaculture is being seen in different parts of the business. Improved fish husbandry, broodstock genetics, farm management systems, diets and engineering of fish holding systems all have a part to play. This Manual deals chiefly with aquacultural engineering but it will be found that to deal effectively with fish farm effluent requires an understanding of other aspects of aquaculture, all of which influence the quantity and quality of the effluent from the process.

This is not a small subject for which there are simple solutions. The Manual does not attempt to provide simple answers. Rather, it seeks to shed light on a complex subject and to assist the reader in acquiring the very necessary understanding that will lead to better decisions in planning improvements in the quality of effluent from fish farms. Because of the variable conditions on fish farm sites across the continent, there will be no single answer to fit all situations.

While this Manual will assist in the complex decision-making process involved in choosing solutions to improve effluent quality, it should not be considered the only source of information. Fish farmers will be well advised to broaden their reading on the subject. The long-time reference for Aquacultural Engineering has been the book of that name by Frederick W Wheaton. Although first published in 1977, it has been repeatedly reprinted since then and remains a good source of information. Another comprehensive publication is *Recirculating Aquaculture Systems*, The Aquacultural Engineering Society, based in USA, has also published a number of reports on their conferences in recent years. These sources of information may be used to raise the understanding of the subject and also as a basis of checking any proposals for treatment that are under consideration.

The metabolic process of growing fish results in by-products which have potential to pollute river systems. This is by no means exceptional; all human activity, and certainly all forms of intensive animal husbandry, result in by-products. What happens to those by-products has been the subject covered by the AQUAETREAT Project now reported in this Manual. Small scale or extensive aquaculture has minimal environmental impact but economic pressures from consumers seeking food at what they consider to be an affordable price, combined with ocean biodiversity depletion, have steered fish farming to become an intensive animal husbandry business. This trend continues. The intensity of production and scale of operation changes the game. Not only do fish farmers and other stakeholders in the process have responsibilities to protect the environment, but the authorities who regulate aquaculture will insist that they conform to strict standards of effluent quality. Within this scenario, fish farmers must find ways of dealing with the by-products of their process that are both effective and economic.

Modern aquaculture is still a young industry when compared with other intensive animal production sectors. The rate of change in technology within aquaculture has been rapid and will need to continue to be so, if the cost of production is to remain competitive in the market for animal proteins. To remain viable, fish farming businesses must operate today to standards that were not even dreamed about two decades ago.

The AQUAETREAT Project has allowed researchers from across Europe to work in partnership. These researchers have brought to their task a range of scientific disciplines and practical experience. They have also brought an independence from commercial influence and a willingness to express their

views candidly. Pan-European Research and Development is common today and brings a cross-fertilisation of knowledge and skills that can speed progress. Bringing scientists to consider problems that have long been perceived to be a burden with which the industry must always exist, can bring new thinking that destroys long-held assumptions.

The Manual reports on work at three very different fish farms with water flow rates through the farms ranging from 15 l/s to 600 l/s and with significantly different climatic conditions. Almost everything in aquaculture should be considered to be site-specific. An important example of this is the astonishing progress made in Denmark over recent years with their Model Farms. These are based on the local presence of groundwater which is a feature of Jutland. While much can be learned from the Danish example, it cannot be lifted in its entirety and installed elsewhere in Europe where site conditions may be very different.

How, then, should a fish farmer approach the task of plotting a course towards improved effluent quality? The best advice is to start with wide reading of the subject, and much forethought. The significant investment costs are likely to deserve professional advice as part of the basis on which to make decisions. However, ultimately, it is the farmer who pays the bills and must take the decisions.

A clear view must be taken about what end result is required. For this, an assessment of the site, the way it is presently used and the intended future use should be the first step. This should be followed by a characterisation of existing effluent which will be influenced by a range of factors. Then, consideration of what improvements can be achieved by

management on the site and without any financial investment in water treatment would be a wise step. These early stages should provide a picture of the degree of effluent treatment required.

An assessment of the site will consider: space available for particular processes, some of which need large areas; the type of terrain, which can affect excavation costs; the available head of water that can assist in moving effluent between process steps; the water temperature regime which will determine the speed of



Figure 2: lagoon
(Photo STM aquatrade)

biological processes; and whether there is land under the control of the fish farmer, where fish sludge can be used to deliver agronomic benefit.

Characterisation of effluent should involve a review of chemical data provided by sampling done by monitoring authorities. This may show variations according to weather conditions, season, time of day that the sample was taken and the effect of work being done on the farm at the sampling time.

Close inspection of suspended solids to establish the average particle size and the spread of sizes will guide the choice of filtration mesh size. It will also indicate whether the content of the effluent is a result of growing fish or is linked to the quality of the water flowing into the farm. Whether particles are organic or inorganic in origin influences the choice of system. Testing sedimentation rates, as described in later chapters, will also guide the choice of treatment system chosen.

The influence of the farm management practices involves feeding rates, the feeding regime, constituents of the diet, oxygen levels and the degree to which the farm management has control over the conditions in which the fish are grown.

The physical design of the farm will affect the degree to which the faeces 'pellet' is broken down before particles are removed from the effluent. The sooner faeces are retrieved, the more complete they will be. Solids removal should be considered as the first important part of any treatment system. Building a new farm, or completely rebuilding an existing farm allows the best design features to be incorporated, but most farms will be retro fitting treatment systems and compromises will be necessary.

Planning for the removal or reduction of dissolved nutrients involves biological processes rather than mechanical filtration. These processes are influenced by matters that are more difficult for the farmer to control and the following chapters will show that, while the systems described are effective, not everything is understood about how they work. An additional complication is that much of the knowledge about biofiltration is commercially owned and the farmer will have to assess the depth of knowledge possessed by the person selling the equipment. Taking references and checking them is a good insurance.

The levels of investment involved can be serious and the costs do not end with the installation of equipment. With farming businesses seeking to improve productivity, care will be needed to ensure that management of any water treatment does not add unreasonably to the workload of those operating the site.

Cost assessments made in a later chapter of this Manual, System Cost Analysis, reveal costs of effluent treatment per kilo of fish grown that will

significantly impact on the tight margins available in the food market. In some circumstances, installation of effluent treatment systems will only be economically viable if grant funding assistance is available.

Work on the three fish farms during the AQUAETREAT Project has resulted in improvements to effluent quality at all three sites. While the project has been in progress, farming businesses across Europe have been applying their minds to water treatment and have arrived at solutions with widely varying degrees of technology and capital investment. Water treatment is likely to become ubiquitous in aquaculture, and fish farmers must develop solutions to the specific challenges posed by their site and their business activity.

References

1. Wheaton, F. W. (1985). Robert E Krieger, Malabar, Florida. ISBN 0-89874-788-0 708pp
2. Timmons M.B., Ebeling J.M., Wheaton F.W., Summerfelt S.T. and Vinci B.J. (2002). Ithaca, *New York Northeastern Regional Aquaculture Center, second edition*. ISBN 0-9712646-1-9, 769pp.

3. Effluent water treatment: Solids Removal

B. Loix

1. Introduction

The metabolic activity involved in converting fish feed to fish flesh produces waste products. These consist of suspended solids (SS) and dissolved nutrients. Suspended solids amount to approximately 25% of the feed used, on a dry matter basis.

This chapter explains methods for the relatively simple removal of suspended solids. The principles involved are applicable to both flow-through and recirculation farms. Removal of dissolved nutrients is explained elsewhere in this manual.

Removal of suspended solids from flow-through fish farms has different requirements from other water treatment processes such as those handling sewage, pig farm effluent or dirty water from a vegetable processing plant: concentrations of pollutants in fish farm effluent are relatively low and flow volumes are relatively high. These large water flow volumes require careful choice of systems to control costs.

2. Origin of suspended solids

In a fish farm, suspended solids and dissolved nutrients originate from:

- uneaten feed
- fish metabolism producing faeces
- solids carried into the farm with the flow from the external water source
- growth of micro-algae and bacteria

3. Factors affecting production of suspended solids

Production of suspended solids within a fish farm is affected by a range of factors, including:

- Feed quality
- Rate of feeding
- Feeding method
- Water exchange rate
- Tank hydrology
- Fish stocking density
- Dissolved oxygen level
- Efficiency of farm management and skills of personnel

The amount of uneaten feed can be reduced by a careful feeding regime that provides the correct amount of feed, at the time the fish require it, and by husbandry that provides water quality suitable for feed conversion. Substantial improvements in feed conversion ratios, and reductions in the faeces generated,

have been achieved by improving fish diets; for example, by using ingredients with high digestibility and diets that are matched to the requirements of the fish species. Selection of feed ingredients can influence the physical stability of faeces on their journey to the point where they are removed by sedimentation or filtration.

Intensification of aquaculture practice, in response to market pressures, has resulted in farms growing more fish and generating significant volumes of suspended solids. As fish farm units grow larger quantities of fish, separation of solids from the water flow before discharge from the site becomes more important. This is particularly true where a number of fish farms are located close together on one river or, in the case of marine farms, where farms discharge close to one another into the sea. The need for treatment is accentuated where the rate of dilution of the effluent by the residual river flow or marine tides is low.

There are particular engineering challenges inherent in the high flows combined with low pollutant concentrations of aquaculture effluents. Particularly low pollutant concentrations are found in flow through farms. Effluent from recirculation farms tend to have higher concentrations but all fish farms have concentrations significantly lower than found in treatment systems for domestic waste water.

4. Choice of Systems to reduce the content of Suspended Solids in farm effluent

There are two methods for reducing suspended solids in fish farm effluent, each of which removes suspended solids from suspension:

- sedimentation – uses gravitational_settlement systems of differing complexity
- mechanical filtration – uses energy and filtration meshes dimensioned to trap solids.

Outside influences will impact on the choice of method used to remove suspended solids. Differences in site-specific situations, including farm location and water quality, bank interest rate, and the cost of energy, cement, labour and land in different countries, will lead to a range of optimal solutions being chosen.

Sedimentation Systems

Before considering gravitational sedimentation methods, it is important to understand the main principle driving the settlement of a solid in water. Gravitational sedimentation uses the force of gravity to extract particles from a fluid. Differences in density between the particles and the fluid cause the particles to travel downward in a quiescent or slowly moving liquid.

The specific gravity of fish faeces is close to that of water and therefore the rate of their sedimentation is low. In contrast, minerals such as sand have a high specific gravity and therefore settle more quickly. Sedimentation rate

depends on the characteristics of the material being settled (including their size), and on the velocity and turbulence of the water in which the particles are suspended. Sedimentation rate is measured in centimetres per second (cm/s). In aquaculture, a favourable settlement speed is considered to be 1 cm/s. Most unused feed and faeces are separable by sedimentation.

Sedimentation of suspended solids is made more difficult by degradation of the feed or faeces 'pellet' as it travels from the fish through the fish-holding area to the sedimentation basin. Water turbulence, created by the speed of water flow and the swimming action of the fish, causes the faeces to be held in suspension and to be progressively abraded and broken down into smaller particle sizes. Very small particles become 'non-settling solids'. This degradation of faeces into smaller particles, when combined with time exposure in the water, leads to a portion of the nutrients contained in the solids becoming dissolved. Fish farm design should therefore aim to trap and remove suspended solids as early as possible after being deposited by the fish, to reduce this degradation process.

Sedimentation is critically linked to the flow rate of water through the sedimentation area.

Sedimentation can be achieved by the following methods and structures:

- Simple sedimentation using a large area – ponds or basins
- Channels, with or without physical barriers
- Quiescent zones and trapping of solids within a raceway
- Lamellar settlement tanks
- Centrifugal concentrators - hydroclones or cones

Simple sedimentation is achieved by structures, variously called sedimentation, or settling, ponds and basins, that make use of the settlement characteristics of the solids (Figure 1). The method relies on a large area to slow the speed of flow, thus allowing time for the solids to settle.



Figure 1: A large settling pond (photo STM aquatrade)

These areas should be designed to achieve laminar flow (see Glossary) of the effluent across the area, and to avoid the water taking the shortest, and fastest, route between the inlet and outlet. It is generally agreed that the residence time should be a minimum of one hour. For example: with a flow of 500l/s (1800m³/h) a minimum pond of 1800m² with a depth of 1m is needed to provide a residence time of one hour.

The requirement for a large surface area of water is the main reason that simple sedimentation is used less often where large water flow rates are involved. When designing a sedimentation area, arrangements should always be made for later removal of the trapped solids.

Channels, with or without physical barriers, are often designed with frequent changes of water flow direction in order to reduce the energy of the solids and accumulate the waste at specific points. The channels can be built in concrete to facilitate cleaning (Figure 2). An improved design using a smaller land area consists of channels with internal barriers which partially obstruct the channel section. The internal barriers decrease the energy of the particles and assist sedimentation.



Figure 2: Settlement tank (photo STM aquatrade)

Alternatively, where space is available, channels can be excavated in water meadows providing sufficient transit time for the solids to settle. Such channels must be designed to allow removal of the settled solids. This is best achieved by having twin channels, so that all the flow can be passed through one channel while the other is being cleaned.

Quiescent zones and in-raceway solids collection (cones) Sections of raceways, usually located before the outlet, can be screened to exclude the fish, thus providing an area with reduced turbulence where solids can settle. A further improvement on this is the installation of collection cones within the floor of the raceway (Figure 3). These cones have a valve system for periodic flushing of the sediment.



Figure 3: Collection cones (photo STM aquatrade)

Lamellar settlement tanks achieve settlement of solids in a restricted land area, by more sophisticated parallel and inclined barriers. They are complicated, expensive to construct and difficult to clean. They are rarely used for fish farm effluent treatment.

Centrifugal concentrators (hydroclones) make use of centrifugal force to separate solids from water. Incoming water is directed tangentially at the top of the cylindrical (uppermost) part of the hydroclone vessel and the velocity of the inflow water is converted to rotary motion, thus creating centrifugal force. Heavy solids are thrown outwards and settle into the lower, conical, part of the vessel for subsequent removal (Figure 4).

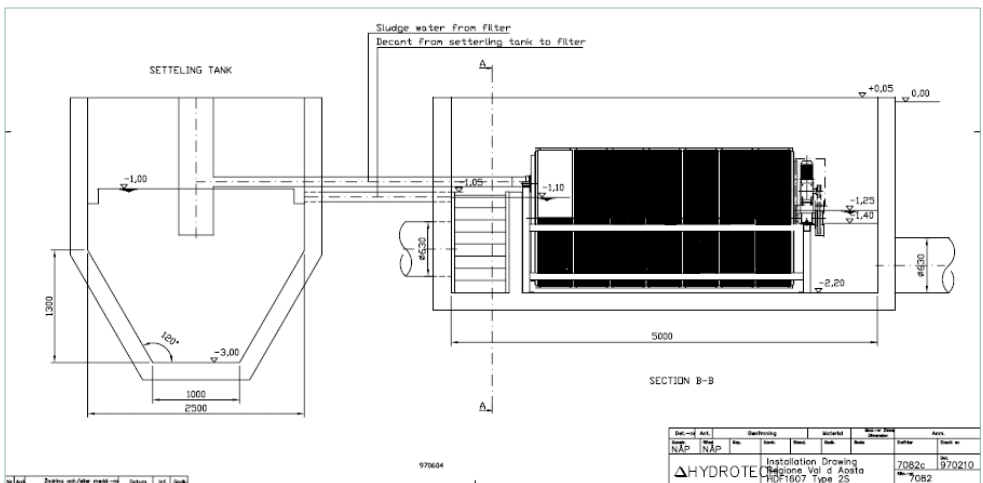

Figure 4: A hydroclone and drum filter installation (drawing Hydrotech)

Hydroclone tanks are effective for high-density solids such as sand and mud but are difficult to use with large flows or with solids having a specific gravity close to that of water, such as fish faeces. The turbulence associated with higher water velocity also contributes to the degradation of the faeces. These limitations restrict the use of hydroclones in aquaculture to specialist situations.

Mechanical Filtration Systems

Mechanical filters remove solids from water using physical barriers through which the solids particles cannot pass. This is usually achieved with a packed medium such as sand or with a mesh. Mechanical filters will remove both settling solids and those that will not settle due to their small particle size or low density.

Before selecting or designing mechanical filters, it is important to know:

- *Type of solids to be filtered*, in terms of their average particle size, range of particle sizes and nature of the material. These can all be site-specific, and depend on the water source as well as the farm construction and management. The characteristics of the solids will influence the material best suited to their filtration, and the filter cleaning process to be adopted.
- *Concentration of solids within the effluent*. This, with the flow rate, defines the loading of material to be filtered and is usually measured in milligrams per litre (mg/l). The combination of type of solids and loading determines the specification of the filter that will be needed to achieve a satisfactory result without continual clogging.
- *Mesh or filter-media size* sets the performance of the filter. Choice of filter is always a compromise, requiring knowledge of the desired degree of solids' removal, the rate of flow of effluent, the suspended solids' loading and the capital investment that the business can afford. Mesh size is measured in microns (mm) (see Glossary).
- *Flow capacity* of a filter describes the maximum water flow that the filter can accept according to type of solid, loading, particle size and backwashing frequency, for a given mesh size. It is measured in litres per second (l/s). The precise flow capacity is a designed feature of any filter and is declared by the filter manufacturer.
- *Energy requirements to operate filter*. Head loss (see Glossary) represents the energy required for a desired water flow to pass through the filter. It is normally calculated based on the flow when the maximum acceptable level of clogging is reached and is measured in metres (m).

Filters are also categorised according to whether they use pumped pressure or gravity with low head loss. Examples of each category are considered next.

Pressure filters are supplied by a pump or by a head of water. Such filters are totally enclosed in order to maintain water pressure across the filtration medium. Head loss through pressure filters varies from 0.5 - 5 bars (1 bar is equivalent to 10 m water head). These filters can be automatically or manually backwashed. Cartridges and bags used as filtration media are not cleaned but have to be exchanged.

Examples of pressure filters are: cartridge, bag and sand filters.

- **Cartridge filters** are the most commonly used filters for very fine filtration, down to 1 mm, when the water flow is low (maximum 1 - 2 l/s). This method is expensive because backwashing the cartridge is not possible. The cartridges are designed to be disposable and are thrown away after use.
- **Bag filters** are theoretically suitable for much higher water flows >100 l/s and can, like cartridge filters, achieve filtration down to 1 mm. The filter is constructed either with a single chamber or with a number of chambers which house the filter bags. Bags are made of various materials, including plastic and stainless steel 316. Bag filters are used in aquaculture for flows up to 15 l/s. Filtering higher flows by this method is uneconomic for aquaculture and is generally only suitable for filtering high value materials in industrial processes.
- **Sand filters** are the pressure filters most widely used in aquaculture. The largest sand filters currently available are 3 m diameter and 3 m high. These can filter up to 50 l/s with a filtration down to 50 mm and an inflow containing <10 mg/l of suspended solids. Sand filters are economical because:
 - sand is cheap and widely available;
 - filter vessels are now made of glass re-enforced plastic, which is less costly than stainless steel.
 - maintenance is simple.
 Sand pressure filters, in common with all pressure filters, have high operating costs due to the energy used for pumping.

Pressure filters are frequently used for filtering seawater at the inlet of a hatchery. They are normally installed in series in order to avoid fast clogging of the finest mesh. When water is to be filtered down to 5 mm, a series of three filters of 100, 50 and 10 mm, respectively, should be installed upstream of the 5 mm filter. The system will work better and the total cost for filtration mesh will be reduced. Cost of filter mesh material increases as mesh size is reduced. It is economic to remove larger particles using larger mesh size.

Gravity filters These include drum filters, disc filters and belt filters, known collectively as microsieves, and use less energy than pressure filters. They pass water through the filter using the gravity, or water head, available at the site. They operate with a low head and water is usually delivered to the filter through an open channel. Such filters are frequently used when large flows, from 5 - 1500 l/s, or even more using a battery of filters, have to be filtered. Microsieves can handle significant quantities of suspended solids and can remove particles

down to 20 mm in size. They are more usually fitted with 60- or 90-mm mesh filters.

Gravity filters typically have a large filter-mesh surface area and a low head loss. They are generally equipped with an automatic periodic cleaning system which is used to avoid the filter clogging with solids.

Drum filters are the most efficient and most widely used filters for aquaculture (Figure 5). Water passes axially into a stainless steel drum, the inner wall of which is made of plastic or metal mesh, through which the water passes by gravity, leaving suspended solids' particles caught on the inside of the mesh. The filter is either in constant movement or its rotation is activated by sensors that detect an increasing difference of water height between that before and after the filter mesh. The backwash cycle is actuated by a timer. Drum filters are suitable for both fresh- and saltwater. Where disposal of solids retrieved from saltwater farms requires low salt levels in the sludge, freshwater can be used for the backwashing.



Figure 5: Drum filter (photo STM aquatrade)

Disc filters are a variation of the drum filter (microsieve) offering a large filter surface area within a relatively small space (Figure 6, see next page). Disc filters are more expensive than drum filters for a given water flow, and are recommended in aquaculture only when the available space is limited.

Belt filters are a third possible configuration for gravity filtration. Water passes through a moving belt which provides the filtration element. The belt

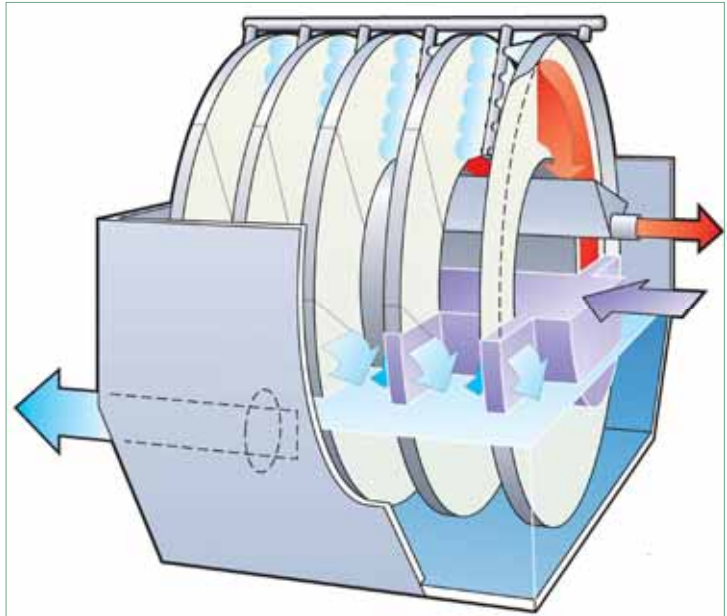

Figure 6: Disc filter (photo STM aquatrade)

is inclined at a shallow angle away from the direction in which the water flow approaches. As the water passes through the belt, any suspended solids that are greater in size than the filter mesh are lifted gently from the flow and are then

washed off by intermittent water jets into a collecting trough. Belt filters have proved effective for low flows heavily loaded with suspended solids.

It should be noted that colloids, which can form a viscous solution, may degrade before the filter and aggrade after the filtration. This gives the impression that the filter is passing particles with a dimension greater than the mesh size used.

The **efficiency of microsieves** at removing solids will depend on the condition in which the solids arrive at the filter. In particular, the degree to



Figure 7: Belt filter in a trout farm (photo STM aquatrade)

which the faeces have been degraded in travelling from the fish to the filter will be critical to filter performance. Different configurations of tanks, ponds or raceways result in varying self-cleaning properties. Circular tanks using a patented dual outlet configuration can achieve a tenfold concentration in suspended solids before any filtration. It is a guiding principle for filtration efficiency that particles are removed as quickly and with as little turbulence as possible.

Table 1 shows the expected efficiency of the filter in relation to different fish tank constructions. Efficiency values can only be indicated as bands (ranges), as much depends on the suspended solids (SS) concentration entering the filter. For example, with inlet SS concentrations <2.5 mg/l, efficiency can be expected to be towards the lower end of the bands, but at an inlet SS concentration of 50 mg/l, efficiency will probably be at the higher end, and can be as much as 95%.

Optimal conditions must be achieved for each of the following key efficiency factors in order to achieve the best filtration result:

- Design of fish tanks or ponds
- Mechanical degradation of particles in the system
- Feed quality and feed management

Table 1: The role of algal photosynthesis in transforming fish farm wastes into usable resources

	Raceway 40 µm	Raceway 90 µm	Self-cleaning tank 40 µm	Self-cleaning tank 90 µm
	Efficiency (%)	Efficiency (%)	Efficiency (%)	Efficiency (%)
Total P	55 - 85	45 - 85	65 - 90	50 - 90
Total N	20 - 25	10 - 25	25 - 30	15 - 30
BOD₅	50 - 80	30 - 80	60 - 85	35 - 85
SS	70 - 90	50 - 90	80 - 95	60 - 95

5. Concentration of Sludge

The equipment most likely to be suitable for treatment of suspended solids at the outlet of the fish farm is a gravitation filter, or microsieve, on account of its efficiency, space saving and low operating cost.

Solids captured by the processes already described will be a suspension of fine particles in liquid, known as sludge. This will be predominantly water and for efficient and economic handling, particularly where the material has to be stored or transported, concentration of the sludge to increase the solids content and to reduce the water content, will be required.

Concentration of suspended solids will vary between farms, and at every stage of the effluent stream within one farm, depending on the activity on the site on a particular day. Generally, untreated fish farm effluents contain between 5mg/l and 80 mg/l SS. Filtration through a microsieve, with a mesh size of 90 µm, concentrates SS at least 25 times and can concentrate the SS in the effluent as much as 80 times. This means that the waste coming from the backwashing of a drum filter can contain as much as 2000 mg/l SS.

Further sludge concentration can be achieved through

- Second filter
- Settlement tank
- Treatment with flocculant and coagulant
- Textile bags
- Dehydration in special tanks or ponds

Second filter The relatively low flow rate of waste coming from the backwashing of the first filter, usually <2 l/s, makes it suitable for sending the sludge to a smaller capacity filter to further concentrate the waste.

Settlement tank Such a tank has a cylindrical upper section with a conical lower section. The cone should be angled at least 70 degrees from the horizontal. Waste is introduced into the top of the tank. Solids descend slowly and the supernatant 'cleaned water' is transferred back to the first filter through an opening in the upper part of the tank. The collected solids in the bottom of the cone section are removed through a valve for disposal using an automated and timed system. The frequency of emptying requires management attention as the quantity of waste will vary through the day.

The combination of a second filter and OR a settlement tank can be expected to achieve further concentration of the sludge up to approximately 7% or 70g/l of SS (i.e. 93% water).

Treatment with coagulants and flocculants

Coagulants and flocculants are chemicals that have properties that make them useful, when added to sludge, in the further concentration of solids. Coagulants and flocculants act on material in the sludge to create (in the case of coagulants) larger molecules or (in the case of flocculants) even larger particles. Since these added chemicals become part of the material that will later be disposed of, care must be taken in their choice to ensure that their use and subsequent products are innocuous and comply with any regulations.

Coagulants are chemicals that promote molecular aggregation. Usually dissolved substances are aggregated into microscopic particles by a coagulant. The most commonly used coagulant is iron chloride (FeCl₃).

Flocculants promote the flocculation of coagulated particles into a macroscopic floc.. They can be classified into two categories, namely organic, containing carbon, and inorganic. Organic flocculants can again be divided into two sub-

groups: synthetic and natural. Natural polymers (see Glossary), often used as flocculants, have advantages in aquaculture because of their biocompatibility and biodegradability. Examples of natural polymers are starch from potatoes or corn; cellulose; alginic acid and guar gum. Synthetic polymers are themselves usually non-toxic, but the associated monomers (see Glossary) often are toxic. They are more effective than natural polymers and are preferred in drinking water treatment. Only small quantities of polymeric (see Glossary) flocculants are required to be effective and they are operative over a wide pH range. Suitable flocculants are found in the polyacryl amide family. DREWFLOC 2488 was found to be effective at Maribrin Farm (See Case Study in this Manual).

The effective dose of coagulant is determined by experiment for each situation (specific waste characteristics and conditions) to which it is applied. This dose is first added to the waste. Then the predetermined dose of flocculant is added. Coagulant and flocculant react together to create large flocs that are more easily removed from the water. Figure 7 shows two bottles containing the same sludge, illustrating the effect of treatment (right-hand bottle) with flocculant and coagulant.

Treatment with coagulant and flocculant should precede passage through a second filter or a settling tank. This should achieve a concentration of SS around 15 - 20% (150 - 200 g/l) or 80 - 85% of water.



Figure 8: Demonstration of the effect of coagulant and flocculant on Maribrin Farm effluent. (photo STM aquatrade)

Textile bags Geotextiles are fabrics with precisely-engineered mesh sizes, usually of 250 – 500 μm . They are manufactured in a tubular form and various sizes of bags are available. When sludge is discharged inside the tube, the water passes through the mesh leaving the solids inside the bag. When the bag is full with sludge, it is ready for disposal. This method is

better suited to cold countries where decay of the material inside the bag causes less gas formation and associated bad odours. The handling process for the full bags, through to disposal, should be established before textile bags are used.

Dehydration Sludge from the final filter / thickening system can be spread into ponds or tanks. These are generally small (a few m²) and shallow (max 50 cm deep). When one tank is filled, another one is used to receive further sludge. The sludge in the first tank will slowly dry and the quantity for disposal will reduce. Dehydration will be faster in hotter climates but the problem of odours has to be faced.

The task of disposal needs to be considered at the outset, as this is likely to require access to the pond by an excavator.

These final treatments generally achieve a sludge concentration of solids of approximately 25% (250 g/l, or 75% water).

6. Sampling procedures

In assessing the performance of solids removal, it is important to sample in a methodical and consistent manner, so that the results are a true reflection of what is happening on the farm.

4. Effluent water treatment: Algal Ponds

Q. Sourget, V. Zonno and J.P. Blancheton

1. Introduction

As availability of freshwater decreases, the future of fish culture will probably be mainly based on seawater culture. Whatever the aquaculture production system, cultured animals produce wastes, mainly composed of solids – carbon (C), nitrogen (N) and phosphorous (P); soluble wastes – carbon dioxide (CO₂), ammonia (TAN), ortho-phosphate (PO₄) and trace elements. These all return to the natural environment.

In the present work, several treatment systems were developed to try to prevent adverse environmental impacts from these aquaculture wastes.

The main types of treatment described are:

1. bacterial dissimilation into gases
2. plant assimilation into biomass.

Bacterial biofilters oxidize ammonia and other organic N forms as urea into nitrate (NO₃), which is less toxic but still a pollutant. Plants assimilate nitrate as a nutrient for their growth.

Fish and many bacteria produce CO₂ and consume oxygen (O₂), while algae generally do the reverse. Consequently, the interest in integrating fish culture with plant culture is that plants utilize solar energy and the excess of nutrients generated from the fish wastes (particularly C, N and P) for their growth.

Algae culture (plant culture in general) is a type of extractive aquaculture. Integrated aquaculture systems utilize the complementarities between productive heterotrophic aquaculture and autotrophic extractive aquaculture for creating value from the nutrients supplied to the system (naturally, and through feed).

2. Basics of algal treatment

Algae use solar energy to turn nutrients (in effluents) into usable resources, by the process of photosynthesis (Figure 1, see next page).

This treatment must be well adjusted to balance the quantity of O₂, CO₂ and nutrient exchanges between the heterotrophic and autotrophic compartments^{1,2}. Where this is so, the fish wastes are considered to be a resource for the algae, which restore the water quality for the fish culture. Accordingly, algal growth is related to fish-effluent parameters (particularly nitrogen, phosphorus, dissolved oxygen) but it is also affected by temperature and light in outdoor systems.

The effect of temperature on algal growth follows the Van't Hoff law (see Glossary) for the majority of relevant species. However, the maximum, minimum and optimal growth temperatures are different from one alga to another

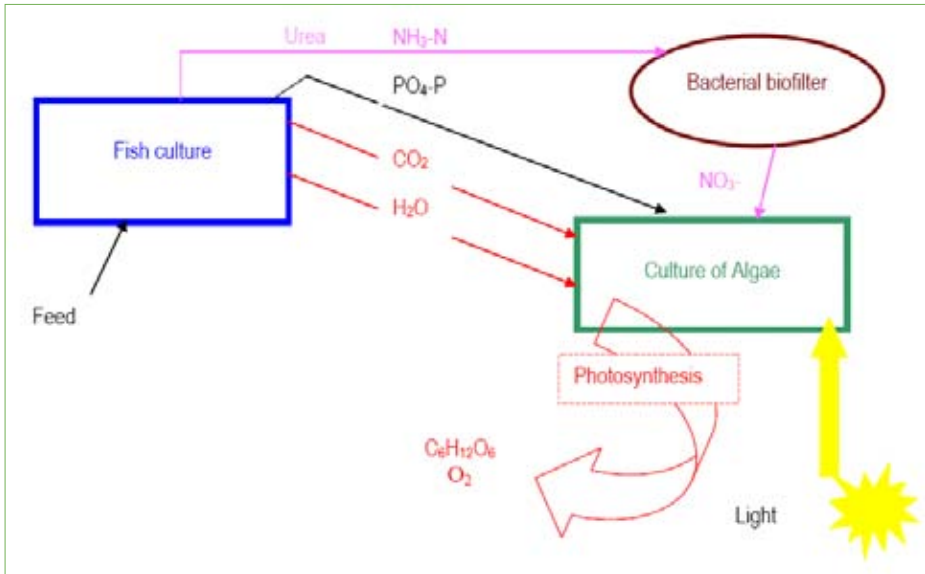

Figure 1: The role of algal photosynthesis in transforming fish farm wastes into usable resources

Moreover, algal growth depends on light intensity, which is essential for photosynthesis.

Therefore, the daily consumption of nutrients by algae fluctuates with the seasons (light, temperature changes). For example, it has been shown^{3,4} that a culture of green seaweed (marine algae) in a high-rate algal pond could take up as much as 90% of the nitrogen produced by a recirculating system for Sea Bass (*Dicentrarchus labrax*) production in summer, but only 30% of the nitrogen production in winter. For phosphorous, the uptake varied between 70% and 0%, respectively, for the same seasons. In temperate climates, temperature, irradiance and day length are optimal for algal development during summer.

In integrated aquaculture, algal biofilters reduce the environmental impact of fish culture. This concept can be integrated into Coastal Zone Management policy^{5,6,7}. The potential benefits of integrated aquaculture using algae are economic and ecological. The algae species selected as the biofilter can be chosen to provide additional benefits, including sale for human consumption; or for phycocolloid-, feed supplement-, agrichemical-, nutraceutical- and pharmaceutical-compounds' production⁸.

Moreover, culture of algae is one of the best solutions for biofiltration, because production costs are low due to the high productivity of the algae⁹.



Figure 2: Pilot-scale High Rate Algal Pond (Ifremer Palavas station)

3. What type of algal pond system - what types of algae?

Types of algal pond systems

There are two main types of algal pond systems: static algal ponds and high rate algal ponds (HRAP). Both can be used to treat the effluents of flow-through or recirculating fish culture systems. The effluents of flow-through systems are characterized by high flow rates and low concentrations of nitrogen and phosphorus. In contrast, the effluents of recirculation systems are 10 - 100 times more concentrated, and have reduced flow rates (1/10 - 1/100 those of flow-through culture systems). Hence the conditions in recirculation systems are particularly favourable to treatment of the water, and limit the impact of aquaculture on the environment.

In practice, static algal ponds are seldom used in aquaculture simply because they require a long water-residence time (months). This requires a large area, which is often difficult to find close to the farm, and is expensive.

High rate algal ponds may constitute a second loop of water treatment of flow-through or recirculating aquaculture systems. They are characterized by a continuous water circulation and mixing in a culture tank, either by a paddlewheel or by strong aeration, and by a short residence time (days) (Figure 2).

Selection of algae species:

Many species of algae have been tested as biofilters. The choice of seaweed species depends on their respective growth rates and nitrogen contents, on the susceptibility to control of their life cycles, on their resistance to epiphytes and disease-causing organisms, and on a match between their ecophysiological characteristics and the growth environment¹⁰.

The SEAPURA Project¹¹ selected five red algae as good candidates for biofilters:

Gracilaria cornea, *G. verrucosa*, *Halopytis incurvus*, *Hypnea muciformis*, and *H. spinella*. These species can reduce about 50% of the ammonia concentration after one passage through an algal tank, and reach 85 - 90% of ammonia removal with a cascade tank¹².

Several investigations selected *Ulva* spp. or *Falkenbergia rufolanosa* as the favourite algae for algal pond systems. Both have a high nitrogen uptake rate, a high biomass yield and commercial value. Their life cycle and nutrient uptake capacities are well known.

Another important aspect of the algal pond approach is the possible valorization of the algal biomass produced:

- *Asparagopsis* is used as a source for halogenated and antibiotic compounds;
- *Gracilaria cornea* is used for the rheological and chemical properties of agar¹³;
- *G. verrucosa* is a potential protein source for human or animal nutrition¹⁴;
- *Hypnea* algae are cultured for their prostaglandin production;
- *Halopytis* for the extraction of dibromophenol and dimethyl sulphophoniopropionate, used as antibacterial agent;
- *Ulva* is used as a sea vegetable, as an aquarium feed or animal feed supplement, as an ingredient in nutraceutical mixtures and as an ingredient in topical preparations such as skin lotions used in spas;
- *Falkenbergia rufolanosa* has antibacterial and antifungal properties.

Treatment efficiency:

The uptake efficiency of *Ulva* spp. to treat the effluents of a recirculation system can reach 0.5 g N/m²/day and 0.03 g P/m²/day for nitrate and phosphate respectively during optimal climatic conditions for algal growth¹⁵.

With the same algae the nitrogen removal rate may reach 2.9 g/m²/day in a flow-through system effluent containing mainly ammonia-nitrogen, with a protein content of the algal biomass up to 44% dry weight¹⁶.

With the same type of effluent, total ammonia-nitrogen removal may be more than double that of *Ulva*¹⁷. Whatever the type of algae and nitrogen source (ammonia or nitrate), the best single-pass removal efficiency is obtained for a low nitrogen flux. However, a high biomass production per unit area is only possible with high nitrogen fluxes¹⁸. Designing such a system requires a

choice to be made of the main objective: that is, between algal production and high overall nutrient uptake (high flux) or low nutrient concentration (and low flux).

As an order-of-magnitude guide, in the climatic conditions of southern Portugal (38°N) around 30 m² of *Falkenbergia rufolanosa* biofilter are necessary to treat the effluent of a system producing 1 tonne of Gilthead Sea Bream (*Sparus aurata*) reared at 21 °C. That biofilter would produce almost half a tonne of algae (fresh weight) per year¹⁹. In the south of France (43°30'N) a biofilter of 150 m² of *Ulva* spp. would be necessary to treat the effluent to keep a standing stock of 2 tonnes of Sea Bass reared at 20 °C over 1 year and it would produce half a tonne of algae (fresh weight) per year^{20,21}.

Reusing the treated water within and from a recirculation system is possible and does not induce fish mortality or biofilter disturbance, and does not reduce fish growth²². A first investigation showed a higher concentration of chromium, manganese, cobalt, nickel, copper, arsenic and thallium in fish muscle reared in a recirculating system compared to a flow-through system. However, as shown in Table 1, these concentrations were far below the FAO recommended values for fish destined for human consumption and the use of an algal pond allowed their reduction²³.

Table 1: Comparison of heavy metal content of fish muscle reared using recirculated farm water after its passage through algal pond treatment systems

	Maximum Recommended values (FAO) (mg/kg dw)	All culture systems (Mean±SD) (mg/kg dw)	Standard values in cultured fish (mg/kg dw)
Arsenic (As)	50 ¹	6.85±1.31	2 – 11
Cadmium (Cd)	0.25 – 10	0.003±0.01	0.3
Copper (Cu)	50 – 150	0.75±1.97	20
Lead ² (Pb)	2.5 – 30	0.05±0.10	2
Nickel (Ni)	2.5	0.16±0.42	–
Zinc (Zn)	200 – 250	13.50±9.35	45

4. Projects and current results

In the past 20 years, several projects have been developed to test and promote algal pond systems as a component of animal aquaculture production systems. Some of these projects are:

The SEAPURA project which, with fish farms in Spain and Portugal, selected, developed and tested cultivation of high-value seaweed species which had not been used before in polyculture. Accompanying research was conducted in Germany, France and Northern Ireland. The goal of the SEAPURA project was the development of sustainable polyculture systems based on economically valuable seaweed species. The cultivated seaweed biomass could be used for the human food market, mainly in France, and for fish feed additives with possible antibiotic effects of the cultivated seaweed, or for extraction of pharmaceutical substances.

The GENESIS project studied several types of integrated systems in warm water (Israel; 29°30'N), temperate water (Southern France; 43°30'N) and cold water (Scotland; 58°N), with a variety of valuable marine products including fish, crustacea, molluscs and aquatic plants. The different systems were evaluated for their performances in respect of water, nutrients and waste management. The GENESIS program also developed suitable products and services for the commercialization of the technology and established the financial viability and consumer acceptance of its products.

The LAGUNEST and PEARL projects focused on the use of algal pond systems to treat the waste water from recirculation systems in order to reuse it. At the time of writing (April 2007) these experiments are still in progress, and will investigate the flesh quality and welfare condition of Sea Bass reared in a completely closed system reusing the waste water, after purification in a high rate algal pond.

5. References

1. Hirata H., Yamasaki S., Maenosono H., Nakazono T., Yamauchi T. and Matsuda, M. (1994). Relative budgets of pO₂ and pCO₂ in cage polycultured red sea bream, *Pagrus major* and sterile *Ulva* sp. *Suisanzoshoku*, **42**(2), 377-381.
2. Rai L.C, Kumar H.D., Mohn F.H. and Soeder, C.J. (2000). Services of algae to the environment. *Journal of Microbiological Biotechnology*, **10**, 119-136.
3. Pagand P., Blancheton J.P., Casellas C. (2000). A model for predicting the quantities of dissolved inorganic nitrogen released in effluent from a sea bass (*Dicentrarchus labrax*) recirculating water system. *Aquaculture Engineering* **22**, 137-153.
4. Pagand P., Blancheton J.P., Lemoalle J., Casellas, C. (2000). The use of high rate algal ponds for the treatment of marine effluent from a recirculating fish rearing system. *Aquaculture*, **31**, 729-736.

5. Chow F.Y., Macchiavello J., Cruz S.S., Fonck E. and Olivares J. (2001). Utilization of *Gracilaria chilensis* (Rhodophyta: Gracilariaceae) as a biofilter in the depuration of effluents from tank cultures of fish, oysters, and sea urchins. *Journal of World Aquaculture Society*, **32**(2), 215-220.
6. Brzeski V. and Newkirk G.F. (1997). Integrated coastal food production systems – a review of current literature. *Ocean Coastal Management*, **34**, 55-71.
7. McVey J.P., Stickney R., Yarish C., Chopin T. (2002). *Aquatic polyculture and balanced ecosystem management: new paradigms for seafood production*. In: Stickney, R.R., McVey, J.P. (Eds.), *Responsible Marine Aquaculture*, CABI Publishing, Oxon. pp. 91-104.
8. Anonymous. (2003). Blue revolution, the promise of fish farming: a new way to feed the world. *Economist*, August 9, 2003.
9. Gao K. and McKinley K.R. (1994). Use of macroalgae for marine biomass production and CO₂ remediation – a review. *Journal of Applied Phycology*, **6**, 45-60.
10. Neori A., Chopin T., Troell M., Buschmann A.H., Kraemer G.P., Halling C., Shpilgel M. and Yarish, C. (2004). Integrated aquaculture: rationale, evolution and state of the art emphasizing seaweed biofiltration in modern mariculture. *Aquaculture*, **231**, 361-391.
11. SEAPURA (2000). Species diversification and improvement of aquatic production in seaweeds purifying effluents from integrated fish farms. SEAPURA final report. <http://www.cbm.ulpgc.es/seapura/index.html>.
12. Neori A., Msuya F.E., Shauli L., Schuenhoff A., Kopel F. and Shpigel, M. (2003). A novel three-stage seaweed (*Ulva lactuca*) biofilter design for integrated mariculture. *Journal of Applied Phycology*, **15**(6), 543-553.
13. Freile-Pelegrin Y. and Robledo D. (1997). Influence of alkali treatment on agar from *Gracilaria cornea* from Yucatan, Mexico. *Journal of Applied Phycology*, **9**, 533-539.
14. Marrion O., Fleurence J., Schwert, A., Guéant J.L., Mamelouk L., Ksouri J. and Guillaume C. (2004). Evaluation of protein in vitro digestibility of *Palmaria palmata* and *Gracilaria verrucosa*. *Journal of Applied Phycology*, **17**, 99-102.
15. Deviller G., Aliaume C., Franco Nava M.A., Casellas C. and Blancheton J.P. (2004). High rate algal pond treatment for water reuse in an integrated marine fish recirculating system: effect on water quality and sea bass growth. *Aquaculture*, **235**, 331-344.
16. Neori A., Msuya F.E., Shauli L., Schuenhoff A., Kopel F. and Shpigel, M. (2003). A novel three-stage seaweed (*Ulva lactuca*) biofilter design for integrated mariculture. *Journal of Applied Phycology*, **15**(6), 543-553.
17. Schuenhoff A., Mata L., Santos R. (2006). The tetrasporophyte of *Asparagopsis armata* as a novel seaweed biofilter. *Aquaculture*, **252**, 3-11.
18. Neori A., Msuya F.E., Shauli L., Schuenhoff A., Kopel F. and Shpigel, M. (2003). A novel three-stage seaweed (*Ulva lactuca*) biofilter design for integrated mariculture. *Journal of Applied Phycology*, **15**(6), 543-553.
19. Schuenhoff A., Mata L., Santos R. (2006). The tetrasporophyte of *Asparagopsis armata* as a novel seaweed biofilter. *Aquaculture*, **252**, 3-11.

20. Pagand P., Blancheton J.P. and Casellas, C. (2000). A model for predicting the quantities of dissolved inorganic nitrogen released in effluent from a sea bass (*Dicentrarchus labrax*) recirculating water system. *Aquaculture Engineering* 22, 137-153.
21. Pagand P., Blancheton J.P., Lemoalle J. and Casellas C. (2000). The use of high rate algal ponds for the treatment of marine effluent from a recirculating fish rearing system. *Aquaculture*, **31**, 729-736
22. Deviller G., Aliaume C., Franco Nava M.A., Casellas C. and Blancheton J.P. (2004). High rate algal pond treatment for water reuse in an integrated marine fish recirculating system: effect on water quality and sea bass growth. *Aquaculture*, **235**, 331-344.
23. Metaxa E., Deviller G., Pagand P., Alliaume C., Casellas C. and Blancheton, J.P. (2006). High rate algal pond treatment for water reuse in a marine fish recirculation system: Water purification and fish health. *Aquaculture*, **252**, 92-101.

5. Effluent water treatment: Constructed wetlands

G. Proffitt

1. Introduction

It is accepted that natural wetland systems can have a dramatic effect upon the quality of water as it passes through them. Particulate matter suspended in the inflow water, along with dissolved organic nutrients, coliform bacteria and even industrial and agricultural chemical pollutants, can be significantly reduced. Their subsequent impact in the downstream receiving waters is ameliorated by passage through a wetland system. This cleaning process continues throughout the year in both tropical and temperate regions.

Over the last 20 years, the natural water treatment process demonstrated by wetlands has prompted considerable interest and research. Initial research centred upon understanding the combined physical, chemical and biochemical processes operating within the wetland system. Later, applied researchers began to examine the practical application of constructing wetlands as wastewater treatment systems.

In the last decade, the concept of integrating constructed utility wetlands (CW) into municipal, agricultural and industrial water treatment provision has become widespread, with examples existing across Europe, the USA, Canada and Australia.

There are a number of advantages in using wetlands in this way, most notably:

- no chemicals or additives are used in the treatment process
- the construction, maintenance and running costs are much reduced compared to conventional water treatment plants
- any constructed wetland can have a positive impact upon the local hydrological system: local water retention, absorption and ground water recharge are all improved by the construction and maintenance of wetland systems
- their aesthetic value is considerably greater than conventional wastewater treatment systems
- even the smallest constructed wetland can have a positive impact upon wildlife and contribute to conservation goals of an area.

Aquaculture waste from land-based farms lends itself well to treatment in constructed wetlands, and a number of freshwater systems are in use in the USA and Canada. However, their development is not yet universal.

Design is of critical importance, particularly when space is a limiting factor. Constructed wetlands must maximise the time that the waste water is in contact with the system. This is the active treatment time, and is known as the hydraulic

retention time (HRT). It is a function of the inflow rate, the volume of the wetland system, the ease with which water can progress through the sub-surface treatment layers, and the final discharge level. Of equal importance is the transmission of oxygen through the substrate to ensure both aerobic and anaerobic conditions, resulting in suitable growing conditions for both naturally occurring bacteria and algae and for the chosen combination of other plants.

There is no single design which will suit all situations; no single planting plan or hydrological system has been found to treat all of the various pollutants equally well. When developing a new aquaculture site or retro-fitting an existing site with a constructed wetland various biological principles, technical requirements, physical constraints and costs must be balanced, in order to provide the most efficient and cost effective operating system.

The constructed wetland design process requires the desired outcomes to be clearly identified. The various elements of the physical design can then be combined to best effect.

2. Basics of wetland water treatment

Even though constructed wetlands have been used extensively for the treatment of a wide range of liquid wastes there is still debate about what elements of the treatment process are occurring at a given time and in a particular position within the wetland. The current inability to accurately identify the location of particular treatment processes and natural activities within the wetland continues to hinder their development, particularly when statutory agencies require quantitative information in order to set and enforce wastewater discharge permissions.

There is no argument, however, that constructed wetlands do successfully clean waste water: polluted water enters the system and the water that leaves it is significantly cleaner. The success of any particular system depends on a number of design features which work together to create the optimum conditions for the physiochemical and biological processes to occur, and to enable a practicable level of their active management.

At a basic level the essential components of a constructed wetland are:

- a simple hollow in the ground or a constructed 'box' generally, but not necessarily, rectangular (in plan view) and sometimes lined
- a mineral bed, as a substrate for the active microbial populations
- a surface layer of soil or mulch.

The surface is planted or left to colonise naturally with water-tolerant plants. Polluted water is introduced to run the length of the hollow / box and exits via a control point.

The design must enable the inflow rate and outflow level to be actively managed.

3. What type of wetland system?

Two basic types of constructed wetlands have been developed; Free Water Flow (FWF) (also known as surface flow) and Sub-surface Flow (SF). They are shown in Figures 1 and 2. Reciprocating and recirculation systems have been developed most recently and are variations of these two basic forms.

Free Water Flow Wetland (FWF)

Water flow is above the ground surface; submerged and aquatic vegetation is established around the margins and within the open water body. Waste water is treated as it moves across the surface of the system and through the surface layers of decaying plant material. Surface flow systems are generally used when space is plentiful and where the visual aesthetic of the site is a priority. They also have the advantage that oxygen is able to diffuse into the system across the air-water interface.



Figure 1: Free Water Flow (FWF) Wetland (photo G. Proffitt)



Figure 2: Sub-surface Flow (SF) Wetland (photo G. Proffitt)

Sub-surface Flow Wetlands (SF)

Water level is below ground; water flows through the mineral bed. Plant roots penetrate to the base of the mineral bed, introducing oxygen directly via their growing parts and enabling passive diffusion of oxygen along older and decaying roots. When designed correctly, sub-surface flow systems have no open water areas. They are more compact systems and are used when space is limited.

The design of free water flow and sub-surface constructed wetlands can be varied to suit local conditions and priorities. Both have been built to function in wild and in urban environments.

4. General Design Detail

Primary settlement

The treatment efficiency of a constructed wetland is enhanced, and its maintenance reduced, if an initial treatment process, such as a sedimentation area or 'pre-treatment' tank, is included in the design. Such an arrangement allows many of the larger suspended solids to settle before entering the main body of the wetland. This reduces the possibility of the media silting up and causing restrictions in flow, and thereby improves the efficiency of the wetland. Pre-treatment is important in both Surface Flow and Sub-surface Flow wetlands.

Secondary treatment

Constructed wetlands can take many forms but the basics of each system are similar. The example detailed in Figure 3 was developed to assist in retro-fitting a series of trout raceways which were surplus to requirements and were designated by the manager for use as effluent treatment wetlands.

Sections A - G in Figure 3 show the main elements which should be included in all constructed wetlands.

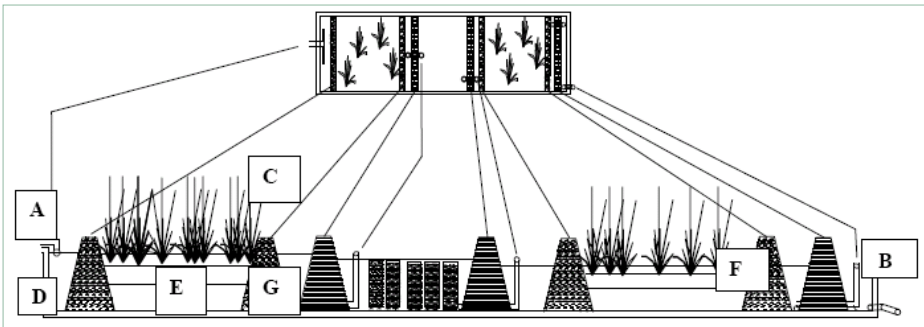

Figure 3: Initial constructed wetland design for Murgat farm, France (G. Proffitt).

This design contains two sub-surface flow cells divided by an open water surface flow cell. Effluent travels through the cells by gravity, moving horizontally across the mineral media and exiting at the base of each compartment, to re-enter the subsequent treatment cell at the surface.

- A. Inflow designed to evenly distribute effluent across the whole entrance to the series of wetland cells.
- B. Variable-level outflow pipes between each of the wetland cells and at the final discharge point. These control points ensure accurate water-level control and enable complete drainage of the system if required.
- C. *Phragmites* (common reed), *Typha* (common bulrush or cattail) or other suitable plant species.
- D. Substrate depth 50 - 70 cm: this depth should ensure full penetration of plant roots, enabling oxygen to penetrate to the deeper levels of the base substrate. Oxygen movement is associated with the root system, both by active transport to the growing root tips and by passive diffusion along the path of older decaying roots.
- E. Constructed mineral bed; mineral pieces with an average diameter of 4 cm ('gravel'). This size allows optimum water flow through the treatment cells whilst providing the surface area for the establishment of bacterial biofilms. The surface of the gravel layer should be covered with a layer of soil or mulch.
- F. Development of plant-litter layer.
- G. Stone gabions retain the gravel and soil whilst ensuring free movement of water.

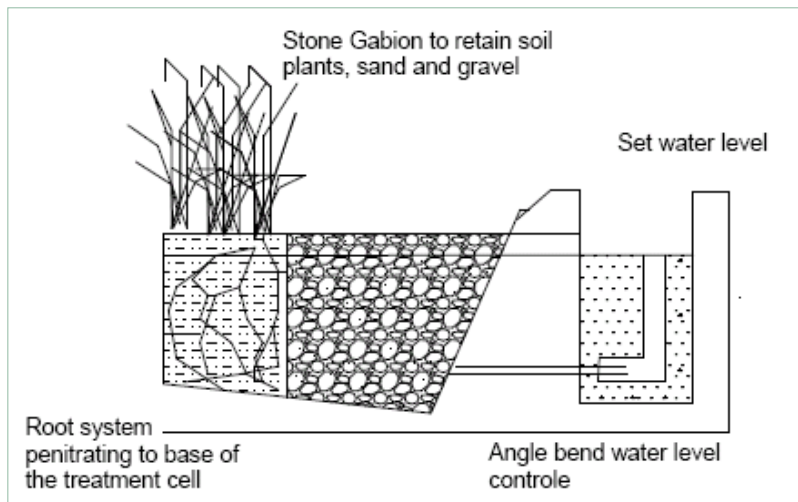

Figure 4: Basic Engineering Features. Transverse section showing detail of retaining stone gabions, plant and gravel interior of treatment cell and water-control piping. (Design recommended by the US Environmental Protection Agency).

5. Treatment-wetland construction details, Murgat farm, France (Figures 5 – 7).



Figure 5: Stone gabions to retain soil and reeds.



Figure 6: Simple water-level control mechanism.



Figure 7: Sluice systems to maintain water levels. Simplest is best (photo G. Proffitt)

6. What type of plants?

Across Europe and the USA the most commonly used plants in constructed wetlands are common reed (*Phragmites australis*), common bulrush (*Typha latifolia*) and common club-rush (*Schoenoplectus lacustris*). When sourcing material it is important to use stock of local provenance because this is more likely to be compatible with the local climatic and soil conditions. Using local

material will also reduce transport costs and limit unintentional movement of non-target species that may be mixed in with the chosen material.

The common reed, used mainly in Europe, has the advantage of spreading faster and rooting deeper than other suitable species. It is easily transplanted as sections of dormant rhizome or as single pot-grown plants. A planting density of 5 - 6 plants/m² will result in full cover in one season. As stated previously, it is important that roots penetrate to the base of each wetland cell. *Phragmites* will naturally root deeply (40 cm). To ensure the deepest root growth, managers should gradually reduce the water level in the wetland in the autumn to encourage new roots to actively 'search' deeper to locate moist soil.

Plants assist the effluent treatment process not only by directly absorbing nutrients through their roots, but by providing the growing surfaces upon which the active microbial biofilms develop. The penetration of roots to the deepest layers of the treatment cells and the spaces remaining after the decay of older roots ensures the presence of the oxygen which is essential for nitrification. The plants also provide the carbon source, in the form of decaying material and substances exuded by growing roots. This available carbon is a necessary component of the de-nitrification process.



Figure 8: Plant species typically used in constructed wetlands. A plant species' growth form, its toughness, and its ability to vigorously develop its root system, are critical factors in the final planting choice (photo D. Holland and G. Proffitt).



Figure 9: Rhizomes of *Phragmites* and *Typha*. (photo Murgat)

7. The use of constructed wetlands in aquaculture

Waste derived from the production of living creatures, animal or human, will consist of solids in the form of nitrogen (N), phosphorus (P), and carbon (C); and of soluble wastes notably carbon dioxide (CO₂), ammonia (NH₃), orthophosphate (PO₄) and trace elements.

From aquaculture, a range of wastes has been described. A recent review of the waste from large cage farms operating in Sweden noted on average 6.4 kg phosphorus and 55.0 kg nitrogen per tonne of fish produced, whereas large land-based farms released 11.3 kg phosphorus and 86.2 kg nitrogen per tonne of fish produced. The calculated average discharge was 8.2 kg phosphorus and 64.7 kg nitrogen per tonne of fish produced¹.

In Hungary, Kerepeczki measured the annual nutrient discharge of a catfish (*Clarias gariepinus*) farm to be approximately 5,100 kg nitrogen, 2,900 kg phosphorus and 29,500 kg organic matter, due to the high level of feed remains². Most of this aquaculture waste is discharged as particulate matter derived from uneaten food and faeces. This is a common mix of waste material, similar to that produced from agricultural systems, where the use of constructed wetlands for waste treatment is well established. It is therefore reasonable to consider the use of constructed wetlands to treat aquaculture effluent.

The aim in developing a constructed wetland as an integral element of an aquaculture production facility is to reduce the potential polluting effect of the discharge on the recipient water or ecosystem. This requires reducing the organic matter in the effluent to an acceptable level, including suspended solids (SS) and 5-day Biological Oxygen Demand (BOD₅); and reducing nutrients, particularly nitrogen as ammonia (NH₃-N) and phosphate.

Suspended solids include all of the solid constituents of waste water, both organic and inorganic. (In domestic wastewater approximately 50% comprises organic and 50% inorganic matter.) Organic material that is

subject to biologically-mediated decay is the main focus in the treatment of waste water.

Suspended solids are very effectively removed in constructed wetlands. Most of the removal occurs within the first few metres of the first cell, where the compacted gravel and soil provide a physical filter. On average, suspended solids can be reduced to less than 20 mg/l from a starting concentration of >100 mg/l³. This reduction occurs within a hydraulic retention time of one day. Little additional reduction of suspended solids occurs beyond this time.

BOD₅ (see Glossary) is a measure of the level of biologically active organic matter in a sample of wastewater. BOD₅ is a similar measure to Chemical Oxygen Demand (COD) (see Glossary) in that it also assesses the extent of organic compounds in a sample. However, COD is less specific than an assessment of biologically active organic matter since it measures everything that can be chemically oxidised.

Clean, unpolluted rivers will have a BOD₅ of less than 1 mg/l. Moderately polluted rivers may have a BOD₅ value in the range 2 - 8 mg/l. Household sewage that is efficiently treated by a modern tertiary process would have a value of about 20 mg/l. Untreated (human) sewage varies, but averages around 600 mg/l in Europe. Slurry from dairy farms is around 8,000 mg/l and silage liquor around 60,000 mg/l.

BOD₅ is reduced rapidly within a constructed wetland by a joint process of settling and physical entrapment of suspended particulate material in the subsurface mineral layers. BOD₅ is reduced to almost zero as the effluent passes across the surface of the gravel media, plant roots and rhizomes, where layers of microbes (the biofilm) effectively utilise the dissolved organic matter for their growth.

Since BOD₅ is closely associated with organic matter in particulate form, a close correlation between BOD₅ and suspended solids concentrations would be expected. As with suspended solids, BOD₅ is quickly reduced in the initial treatment cell and a hydraulic retention time of >1.5 days shows very little additional BOD₅ reduction.

Table 1: Typical BOD₅ values across a range of natural and waste waters

BOD ₅ (mg/l)	Water Quality	Examples
1	Very Good	Pristine river
1 – 2	Good to Moderate	Flow-through fish farm
2 – 8	Moderately clean	Moderately polluted river
20	Somewhat polluted	Effectively treated (human) sewage
600	Very polluted	Untreated (human) sewage
8,000	Extremely polluted	Dairy farm slurry
60,000	Extremely polluted	Silage liquor

8. Nitrogen and Ammonia

When organic nitrogen from wastewater enters a constructed wetland a process of decomposition and mineralization converts a significant portion to non-ionised ammonia (NH_3). This is a major pollutant, toxic to a range of aquatic animals, including fish. Its removal in constructed wetlands occurs by complex biological processes, involving aerobic nitrification followed by anoxic de-nitrification. More details of the biochemical processes are described by Anderson *et al*⁴.

The process of nitrification requires oxygen and will not proceed effectively in anaerobic conditions. Oxygen needs to penetrate throughout the wetland cells for the successful breakdown of ammonia. Actively growing root systems which are able to penetrate to the base of a treatment cell provide oxygen for the process, and bacteria directly associated with the living roots, and possibly inhabiting the spaces left by older decaying roots, undertake the transformation of ammonia to nitrate. The removal of ammonia takes far longer than the reduction in suspended solids and BOD_5 ; a hydraulic replacement time of 4 - 7 days is required for a reduction of 80% - 90% to take place. Full root penetration to the base of the treatment cells is required, or some areas with surface water open to the air should be incorporated, as in the Murgat farm example. If possible, it would also be an advantage to introduce aeration-cascades between treatment cells. In practice this is rarely possible unless there is a significant difference in ground level between cells.

The biological uptake of nitrogen in constructed wetlands can proceed at a rate of 200 - 800 mg $\text{N}/\text{m}^2/\text{day}$. This rate of removal from the system is dependent upon the success of the wetland design and the impact of regional and seasonal variation.

9. Phosphorus

Phosphorus is a key element for a range of structures and processes in all living systems. The most important commercial use of phosphorus-based chemicals is the production of fertilizers. In ecological terms, phosphorus is often a limiting nutrient in many environments, that is, the availability of phosphorus governs the rate of growth of many organisms.

In ecosystems an excess of phosphorus can be problematic. It is an essential nutrient in limited supply. Therefore, whenever free phosphate is available it promotes vigorous, and in many cases excessive, growth, especially in aquatic systems. Heavy algal pollution ('bloom') is usually triggered by excess phosphate. Even where nitrogen levels are high, a lack of phosphate in a system will restrict excessive algal growth.

Removal of phosphorus from natural systems is difficult; within a constructed wetland its removal is equally difficult. Removal of phosphate can occur in a number of ways. Binding directly with submerged soil traps phosphate until all the available sites are occupied. Once the sites are 'full' no further phosphate can be accommodated and any more entering the system is

discharged. Phosphate can also be chemically transformed into non-soluble particulate forms by the addition of iron, aluminium oxides, and calcium carbonate in the form of limestone. These combined forms are then removed as suspended solids.

If the removal of phosphate is a major aim of a constructed-wetland effluent treatment process, additional capacity will be required to incorporate the additional volumes of smaller-diameter mineral bed (sand) needed to bind the phosphate successfully.

10. Potential impact of adding a constructed wetland to the operation of a farm

Expected results

A comprehensive review of constructed wetlands by the US Environmental Protection Agency concluded that significant reductions in all of the following water quality parameters can be expected⁵:

Table 2: Reductions of water quality parameters of constructed wetlands

	Range of recorded reduction
Ammonium / Nitrogen	86 - 98%
Total Inorganic Nitrogen	95 - 98%
Total Phosphate	32 - 71%
Suspended Solids	70 - 95%
BOD5	65 - 95%

These results, although not derived from aquaculture operations, indicate the potential significant impact of using constructed wetlands to treat aquaculture waste. Direct evidence of this potential has recently been demonstrated by researchers at the Leibniz Institute for Freshwater Ecology and Inland Wetlands in Hungary. They retro-fitted a constructed wetland to an existing flow-through trout production facility and demonstrated significant reductions in pollutants equal to those noted in other wetland systems treating a range of waste materials.

Suspended solids, chemical oxygen demand, total phosphorus and total nitrogen from tank effluents were reduced in a sub-surface flow system by 92 - 97% (SS), 64 - 74% (COD), 49 - 69% (TP) and 21 - 42% (TN). Treatment efficiencies for suspended solids, chemical oxygen demand and total phosphorus were similar in winter and in summer. However, reduced denitrification in the cold season resulted in increased amounts of nitrate-nitrogen (NO₃-N) and total nitrogen. Purification of backwash water from microsieve filters resulted in treatment efficiencies for suspended solids, chemical oxygen demand, total phosphorus and total nitrogen of 97 - 99% (SS), 87 - 93% (COD), 83 - 98% (TP) and 83 - 96% (TN)⁶.

This examination indicates that, if correctly designed, constructed wetlands could have a significant impact upon the quality of waste water discharged from aquaculture production facilities.

11. Conclusions

Constructed wetlands are considered a viable and cost-effective method to treat waste water. Their incorporation into aquaculture operations is technically feasible. The addition or integration of a constructed wetland into an aquaculture production process represents an environmental enhancement, and has the potential to assist cost-effective compliance with increasingly stringent water quality regulations in Europe.

12. Advantages of establishing a constructed wetland

- Wetlands are less costly to construct and manage than standard, hard-engineered, waste treatment systems.
- Energy use is low, the level of technology is minimal in comparison to standard systems. As a result, the operation and maintenance costs are lower and labour commitment is periodic.
- Wetlands are able to tolerate fluctuations in flow so they facilitate water re-use and recycling.
- Wetlands provide numerous benefits in addition to water quality improvement, such as wildlife habitat and the aesthetic enhancement of open spaces.
- Wetlands can be built to fit into the existing production facilities, utilising space between production facilities or even occupying disused elements of the farm infrastructure, such as raceways and channels.
- Wetlands can often fit easily into an existing soft landscape and so may be viewed with favour by the general public and planning authorities.

However, irrespective of how advantageous and feasible a technology is to adopt, it would be unwise to proceed without proper consideration of the potential problems:

- A constructed wetland may require a larger land area than a conventional wastewater treatment system.
- Performance may be less consistent than in conventional treatment systems; flushes of pollutants or surges in water flow may temporarily reduce treatment effectiveness.
- The biological components are sensitive to toxic chemicals, such as pesticides.
- The effectiveness of constructed wetland water treatment systems depends on complex physical, chemical and biological processes, highly adapted to local conditions. Therefore a range of detailed designs is feasible and a consensus on their optimal design may not be an appropriate goal.

It is advisable to discuss your particular project directly with colleagues who operate existing systems, including partners in the AquaETreat programme, to find new contacts and advice.

13. References

1. (Alånåra A, *et al.* (2006). The nutrient load from Swedish fish-farms. Paper presented at Aqua2006 conference, Florence, May. European Aquaculture Society Conference Report.
2. (Kerepeczki, É. (2006). *Treatment of intensive fish farm effluent in a combined fishpond-wetland system*. Paper presented at Aqua2006 conference, Florence, May. European Aquaculture Conference Report.
3. Sherwood C.R. (1993). *Sub-surface Flow Constructed Wetlands For Waste Water Treatment*. US Environmental Protection Agency. EPA 832-R-93-008.
4. Anderson I.C. and Levine J.S. (1986). Relative rates of nitric oxide and nitrous oxide production by nitrifiers, denitrifiers, and nitrate respirers. *Applied Environmental Microbiology*. **51**, 938–945.
5. Sherwood C.R. (1993). *Sub-surface Flow Constructed Wetlands For Waste Water Treatment*. US Environmental Protection Agency. EPA 832-R-93-008.
6. Schulz C. *et al.* (2006). *Treatment of rainbow trout farm effluents in constructed wetlands*. Paper presented at Aqua2006 conference, Florence, May. European Aquaculture Society Conference Report.

6. Case Study: Hojhoy

R.W. Lovitt

1. Introduction

Hojhoy is a small recirculation fish farm producing 90 - 150 tonnes of Rainbow Trout (*Oncorhynchus mykiss*) per year. The trout are grown from fingerlings to about 700 - 1000 g. They are then sold on to a Sea Trout cage site or for the table or other food processing.

The Danish fish farming industry is under rapid and substantial redevelopment as a response to the strict environmental regulations laid down by the Danish government and the need to decrease production costs within this legislative environment. The main method by which farms are regulated is by the routine measurement of effluent quality, and by feed quotas, to limit nutrient input into the system. The general response of the farmers has been to invest in water treatment technology and effective control systems to maximise food conversion and minimise emissions. With the emissions controlled, and effluent treatment demonstrably more efficient, increases in feed quota are allowed, so permitting more fish to be produced. This rewards the investment in water treatment. The overall aim of this water quality loop strategy is to improve the quality of water effluent while also allowing an increase in the production of fish.

A response to these economic and regulatory forces has been to increase the degree of water recirculation and to increase stocking density within the farms. Farms are becoming more intensive and productive while controlling labour and energy costs. The Danish fish farming industry has evolved, and is developing "model farms" where the water within the farm is replaced at a rate of one volume replacement per day. This water exchange rate is low enough to avoid excessive water abstraction from streams; it allows farms to rely more on ground water abstraction. Biosecurity is thereby improved, and higher winter and cooler summer water temperatures are achieved. These conditions result in improved oxygen solubility in summer and a better growth and feed conversion ratio in winter. Annual production is increased, while maintaining optimum oxygen concentrations in the raceways.

Stocking levels in these systems are in the range 40 - 100 kg/m³ depending on the precise arrangement of each farm. Apart from the cost of water use, other important cost factors on these farms are the reduction of manual labour and energy usage.

The basic comparison between a recirculation farm and a flow-through system is that in a recirculating system considerable additional effort and investment is required for treating the water and for its recirculation. This typically involves additional equipment and energy, commonly including the construction and operation of a biofilter, the provision of some form of filtration to capture solid

wastes (interceptor filters and microsieves), the provision of aeration in the form of air (energy and compressor costs) or oxygen. The final stage of water treatment common to all Danish recirculation farms is the use of a wetland to polish the effluent water before release.

Most importantly, in recirculation systems the costs of oxygenation and pumping have to be minimised. In most cases these requirements are met by careful hydraulic design to reduce pressure heads so that low-energy pumping using air-lift systems can be used. Importantly, the air-lift systems also facilitate carbon dioxide degassing that is needed to avoid potential problems at high stocking densities.

Recirculation systems can be improved further in a number of ways. For example, the level of water recirculation can be increased to only 5% water replacement per day, or water sterilisation can be made feasible, as shown in recirculation systems in hatcheries and high-value marine species. Another option is the additional treatment of the effluent water to reduce the concentrations of pollutants even further. However, in these cases, the necessary investment in water treatment rises while the potential for build-up of inhibitory materials in the water makes the use of high recirculation rates unjustifiable for low-value species such as trout.

Højhoy farm is sited near Skjern, Ringkøbing, Jutland in Denmark and has many of the features of a “model farm”. However it is relatively outdated in achieving water recirculation by mechanical pumping rather than by air-lift, and in using relatively deep raceways for rearing the fish. The general layout of the farm is given in Figure 1.

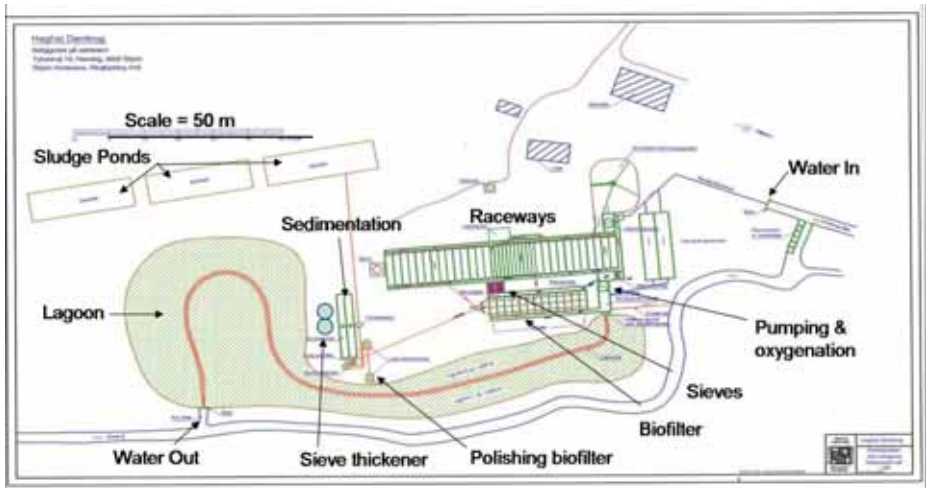

Figure 1: Plan of Højhoy Farm. The main features of the farm in relation to sludge handling and water treatment.



Figure 2: Hojhoy Farm. Raceways (A) and (B), lagoon (C) and sludge ponds (D). Refer to Figure 1 to locate the relative positions of these features on the farm.

2. AquaETreat research at Hojhoy

Farm description and operation

Hojhoy farm takes water from the local stream at 15 l/s (Figures 1 and 3). The water passes directly into the farm raceways via screens to keep out wild fish, but with no further pre-treatment.

Water is circulated around the raceways, through two drum filters, then through a biofilter, before being raised 0.6 m by two pumps arranged in parallel. A fraction of the water can be pumped to oxygenation cones during the lift. This facility is used intermittently when oxygen demand is high, typically after feeding.

The rate of flow through the farm is 700 l/s and the total water volume of the system is 1200 m³ (900 m³ raceways, 120 m³ biofilter and the remainder in connecting channels). The biofilter has 12 compartments, each of 10 m³. Water circulates round the whole loop in about 30 minutes, with a 21-minute residence

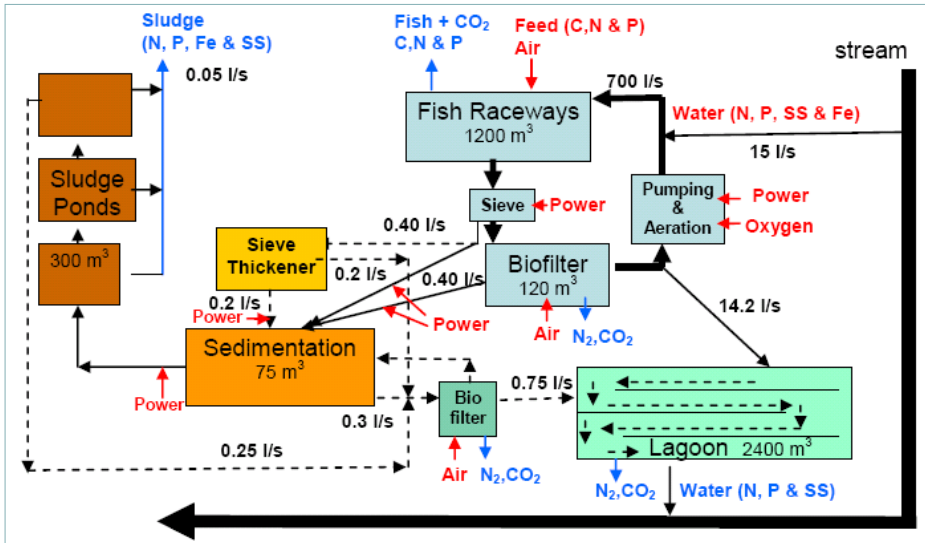

Figure 3: Flow diagram of the farm showing key inputs, outputs and flows. The flows show average operation during the period of study. Red figures represent inputs of feed (C, N and P), energy and oxygen (in the form of air and oxygen). Blue represents the outputs of the system: fish; dissolved and particulate C, N and P; and carbon dioxide and nitrogen gases.

time in the raceways and 2.5 minutes in the biofilter. Farm effluent water (Figure 3; 14.2 l/s) is sent to a lagoon with a capacity of 2,400 m³. The overall retention time for water within the site is 3 days.

During 2005, the farm held 40,000 - 60,000 kg of trout and used an average of 265 kg/day of feed. The farm produced about 90,000 kg of fish (FCR 0.94). Since improvement of the water treatment system, the feed quota has been raised to 150 tonnes per annum and production has increased. Increased fish production will increase loading of nutrients on the biofilter and effluent treatment systems. Figure 3 shows the average flow rates around the system. It shows the main recirculation loop and the return water flow to the stream via the lagoon, plus various operations for capture and thickening of the solids in the system.

Apart from the direct return of water to the lagoon from the recirculation system, there are two flows of water containing solids. The first is a continuous feed from the microsieve drum filters (about 0.4 l/s); the second is an intermittent flow (averaging about 0.4 l/s) from the biofilter washing. Originally, these two streams were combined in the main sedimentation tank and all this water, with a high loading of solids, was put into the sludge ponds. The management and operation of these two key flows were the subject of the AquaETreat research, which is discussed in more detail

below. Elements of the effluent-treatment equipment at Højhoy are shown in Figures 2 and 4, including those for aeration, mechanical filtration (microsieve drum filters) and oxygenation (cones).

Microsieve drum filters

The basic design of a microsieve drum filter has a metal frame (drum) on which fine wire- or plastic-mesh panels are fixed. The inflow end of the (horizontal) drum is open while the opposite end is blocked. The drum is set in the water and is rotated on its horizontal axis at two revolutions per minute (rpm). Water enters the drum and passes through the filter mesh by gravity. Particles in the water are captured by the mesh and accumulate on the mesh surface. They are then removed by a high-pressure water-jet 'backwash' which is collected as a concentrated particulate stream. The size of drum filter mesh is typically 60 - 100 microns (μm). There are two widely-used drum-filter manufacturers: Hydrotech (Sweden) and Faivre (France).

For a given flow of water to be filtered, the key operating variables are mesh size, the mesh area of the drum, the drum rotation rate and the backwash water flow rate. The specifications selected for these variables will depend on the nature of the solids being filtered. The choice influences the concentration of the sludge that will be collected.

There are two drum filters at Højhoy, fitted with 75 μm mesh. Each is 3 m long and 1.5 m diameter, giving a total potential filtration area of 13.1 m^2 . The drums had been 30% submerged, but have now been lowered to 80% submergence. This increases the area of submerged filter mesh to 10.4 m^2 , rotating at 2 rpm (Figure 4).



A

B

Figure 4: Microsieve drum filters. The photographs show the sieves operating under two conditions. (A) the sieves are set relatively high, with about 30% immersion. (B) the current position, with sieves 80% immersed. See Figure 1 for the sieve drum filter location.

The flow rate of the backwash jet is 0.3 - 0.4 l/s, depending on conditions. The jet water is pumped from the recirculation loop at a point after the biofilters, because this is the cleanest water readily available. Spring water containing high concentrations of iron (Fe) is now being considered for backwashing because adding iron improves flocculation and sedimentation of the solids.

Operation of the filters is a key factor in the successful effluent management of the farm. The filters remove large particles from the system and with them much of the potentially polluting organic content of the effluent, in particular Carbon (C), Nitrogen (N) and Phosphorus (P).

The backwash flow rate is a compromise between the cleaning efficiency of the spray water and the volume of water used, and dictates the concentration of sludge produced. The sludge from the drum filter backwash is in the range 100 - 500 mg/l dry sludge. There are problems associated with very high flow rates, as used at Hojhoy. Such high rates disrupt the sedimentation properties of the solids. These are discussed later. An analysis of the sludge stream from the drum filter is shown in the Appendix.

Management of the drum filter involves regular washing of the mesh, the framework and the guttering with a jet hose. The amount of power used for this is relatively small.

Biofilter design and operation

The second source of sludge is the biofilter washings. The biofilters are another key part of the water treatment system.

Biofilters convert, and thereby remove, the toxic component, ammonia, by a) biological (microbial) oxidation of ammonia to nitrate (nitrification) and b) biological reduction of part of the nitrate to nitrogen gas (denitrification).

The physiology and biochemistry of ammonia oxidation is complex and can be completed by a diverse range of micro-organisms; exactly which depends on conditions within the biofilter. The conversion of ammonia is fastest and most simply achieved in conditions with low organic carbon and high ammonia. The nitrifying bacteria that convert ammonia to nitrate are very slow-growing and are retained in the system attached to the media packing of the biofilter. Furthermore, for good operation, the maximum concentration of ammonia should be about 1 ppm (1 mg/l). This limits the processing rate and is well below the levels required for the most rapid ammonia oxidation.

A typical biofilter will remove up to 300 mg/day/m³. To achieve this performance, however, the surface film of micro-organisms should be thin and the filter must be cleaned regularly to maintain the material in its most active condition. Hence very large surface areas are required to convert the ammonia. If the system is disrupted and sub-optimal conditions persist, the oxidation of ammonia is reduced, allowing a build-up of ammonia and, more problematic, the build-up of the partially-oxidised product, nitrite. Nitrite is

highly toxic to fish. For this reason it is prudent to provide an over-capacity of biofilters in the overall farm design.

There are generic types of biofilter design based on , named according to the packing arrangement of the media used: either fixed beds or moving beds with their packing media floating in the water and agitated by gases (also called floating beds). The moving-bed filters are considered to be the most advanced because they are constantly cleaned by abrasion from the collisions between the media elements. This maintains the performance and reliability of the filter. The large abraded particles are collected by the filtration system, typically a drum filter.

Fixed-bed biofilters achieve nitrification, some denitrification and particle filtration. The packing media will trap particles passing through and require regular washing to remove the trapped materials and to maintain the nitrification activity.

The biofilters at Hojhoj

The main biofilter installed at Hojhoj is of the fixed-bed type. The biofilter design described above, and shown in Figure 5 (see next page), consists of 12 chambers, each with a packed volume of 10 m³ and measuring 2 m wide x 5 m long x 1.2 m deep. The chambers have grids at the top and at the base to retain the filter media.

The biofilter packing material is in the form of a plastic ring (Kaldnes type) and occupies about 60% of the filter volume. The total surface area of the media is 800 m² per m³. The biofilter is aerated at two levels: at the base and at about 600 mm depth.

During routine operation, only the top half of the filter is aerated and this has the effect of forcing a substantial portion of the filter media against the upper grid. Below the aeration zone the media are supported by the lower grid. This layer of the bed is stable and acts as a deep 'fixed' filter, capable of removing small particles. When operating, the waste water passes up through the filter, through the fixed media, and then through the aerated media (Figure 5, see next page). The water flow velocity through the media is around 50 mm/s. This is slow enough to allow substantial particle capture on the plastic media

The media in the chambers is cleaned on average on a 9-day cycle. First, 2-3 m³ of water is withdrawn so that the biofilter media fall back into the chamber; at the same time aeration is substantially increased and actuated below the media in the lower section of the chamber. The vigorous agitation causes the media particles to abrade each other and to release surplus biomass from the plastic media. After 20 - 30 minutes the biofilter water containing the released biomass is drained off and pumped to the sedimentation tank. The filter chamber is refilled to about 8 m³ with new (recirculating) water and the washing process is repeated. Finally, a third wash is similarly completed. Typically, each stage of the washing process takes 20 - 30 minutes, so washing each filter takes about 1 - 1.5 hours.

The biofilter cleaning produces about 35 m³ of wash water per day (i.e. 0.40 l/s).

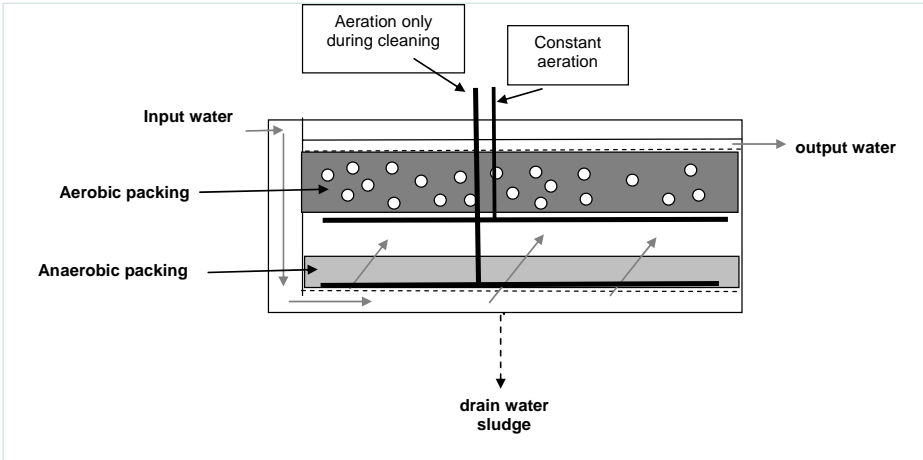

Figure 5: Biofilter design and operation. (A) Diagram of the biofilter design (B) Photograph of the biofilter in operation.

The biofilter consists of 12 compartments. Each compartment has a flow of 60 litres per second and gives about 3 min residence time within the filter. The aerobic part of the filter accounts for nitrification while the anaerobic part allows for some denitrification within the system. During cleaning the water is lowered to below the upper grid and the base aeration is vigorously applied. This causes complete mixing of the packing media and abrasion causes release of excess biofilm. Refer to figure1 for the location of the biofilter.



The average composition of the sludge from the biofilters is shown in the Appendix.

Sludge handling: the farming constraints

At Hojhoj, installation of the recirculation system had just been completed when the AquaETreat project started. The main farm objectives were to improve overall performance of the farm so that the fish production could be increased while maintaining good water quality of the effluent and reducing energy consumption.

As part of this larger farm improvement scheme, the AquaETreat project studied the on-site solids collection and sludge thickening processes, with the aim to thicken the sludge, thus reducing the volume of material to be

handled, and to return as much water as possible back to the lagoon. The first stage of the project involved studying the nature and handling properties of the sludge; i.e. its composition, physical and chemical properties and other characteristics. Based on this knowledge, the second stage was to design an improved sludge-thickening system while maintaining a good quality of water effluent. At the same time, it was intended to gain a better understanding of microsieve drum filter operation for solids capture and sludge thickening. The potential uses of treated sludge were also considered (see also Chapter on Fish Sludge).

Sludge collection

The farm produces two types of sludge: that from the drum filters and that from the daily cleaning of the biofilter. Sludge handling of the two waste streams gives a total of about 0.80 l/s effluent containing suspended solids. Before the start of the AquaETreat project all the farm's sludge water was pumped from the main sedimentation tank to porous sludge ponds (900 m³), from where the water soaked away. The nature of the local geology caused any dissolved phosphate to combine rapidly with iron and restricted phosphate release to the environment.

Sludge characteristics

a. general

Under the AquaETreat project the two sludge flows were characterised. The results are summarised and compared in Table 1 (see next page).

The Table shows that concentrations of Total N, Total P, and Fe in the solids are greater in the biofilter sludge than in the microsieve drum filter sludge. This is probably because the biofilter captures very small particles. The average particle size in the biofilter sludge was 140 µm, compared with an average of around 100 µm in sludge from the drum filter.

The range of particle sizes in the sludge from the biofilter is also slightly larger than the range of those recovered from the drum filter. The zeta potential (see Glossary) of the drum filter particles shows that they possess a considerable negative charge, even at very low (acid) pH. This suggests that much of the charge is related to inorganic rather than organic materials. The most probable source is phosphate, as indicated by the P content in the sludge analysis.

Table 1 also shows that the drum filter sludge is more dilute than the biofilter washings, with relatively low concentrations of N and P.

The sludge from both sources is very high in iron, particularly that derived from the biofilter. Again, this is probably because the biofilter captures very fine particles, including the colloid iron suspended in the water. A detailed analysis, including the elemental composition, of the sludges is shown in the Appendix. It indicates the very high levels of phosphorus in these sludges.

Table1: Sludge composition at Hojhoj; Analysis of samples from 3 months in early 2005, Average flow.

Parameter	Sieve backwash	Biofilter washings ¹
Average flow (l/s)	0.70	0.4
Average solids flow (mg/s dw)	140	226
Total Suspended Solids (mg/l dw)	254	1113
Total N (mg/l)	5.5	34.3
Total P (mg/l)	1.9	22.5
Solids (in sludge) (mg/l dw)	0.3	3.4
Fe (in sludge) (mg/l)	4.0	73.7
Particle size (μm) ²		
	D0.1	20.2
	D0.5	99.9
	D0.9	426.0
Zeta potential, (mV) ³		
	pH 11.4	-35.5
	pH 7.4	-21.5
	pH 3.4	-14.3
		Not determined
		Not determined
		Not determined

1. *Biofilter washings are the average of three sequential washes and the values are an average of 3 duplicate samples.*
2. *Particle-size distribution was measured by laser light diffraction using a Malvern master sizer. Values are the average of 6 samples taken over a three-month period. The three characteristic sizes are shown for the bottom 10% (D0.1), bottom 50% (D0.5) and bottom 90% (D0.9) fractions.*
3. *The zeta potential (ζ) was obtained by measurement of the electrophoretic mobility as a function of pH. The data are shown for three pH values.*

b. Sedimentation properties

To study sedimentation properties, sludge was collected from the microsieve backwash water and from the biofilter washings from the flows entering the sedimentation tank (Figure 6). At the sampling point, both sludge streams have passed through centrifugal pumps, which reduce the particle size within the streams and thus increase the concentration of very fine particles.

The samples from the drum filter backwash were finer and therefore the most problematic: Figure 7(A) shows that they were more likely to produce some floating sludge which sank slowly, taking 60 - 120 minutes. This floating characteristic was caused by the incorporation of fine bubbles, derived from the high-pressure drum filter backwash jet and the subsequent pressurisation of this water during pumping to the sedimentation tank. It was found that the problem could be minimised by reducing the pressure and the



A

B

Figure 6: Sludge characterization at Hojhoy. (A) The two sludge flows from the recirculation system to the sedimentation tank. The flow on the left is the large but intermittent flow from the biofilter. The flow on the right is the small continuous flow from the microsieve drum filter. (B) Sludge from the microsieve backwash illustrating the foam (small air bubbles) and the floating sludge. The floating sludge sinks when the gas bubbles dissolve, in about 1 hour. The rate of dissolution depends on the sludge concentration.

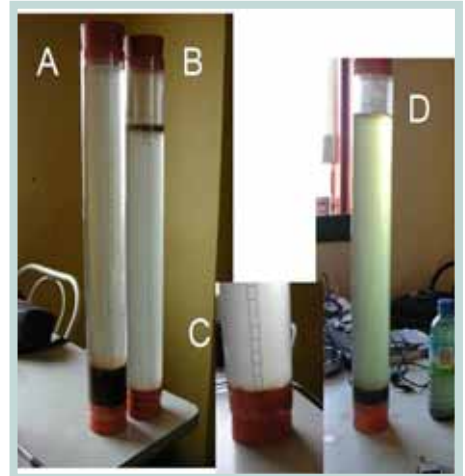
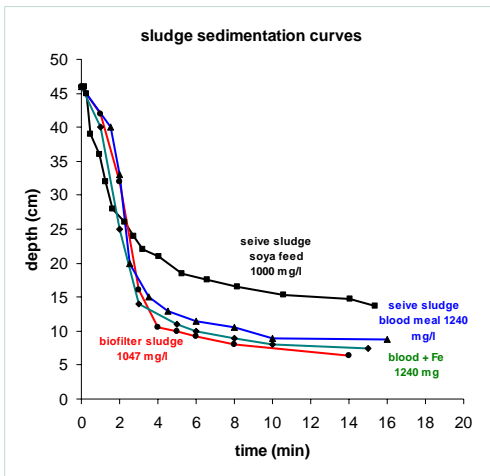

Figure 7: (A) Sedimentation curves for various types of sludge from the farm. The sludges were diluted so that they contained a similar concentration of materials (about 1000 mg/l). The sedimentation properties are therefore a direct reflection on particle size and density rather than being related to concentration of the sludge. Biofilter sludge and the sieve sludge from blood meal feed gave good settling velocity. (B). Examples of sedimentation tube studies showing changes in sediment characteristics and finely suspended materials (A) Biofilter sludge showing complete settling after 20 min. (B) Sieve sludge from a soya based feed, setting after 20 min, note the significant amount of sludge that remains at the surface (C) Enlargement of (B) to show the loose settled floc (D) Sieve sludge from a blood meal supplemented feed. Settling was again complete after 20 min.

flow velocity of the backwash water. This also increases the concentration of solids in the stream and reduces the gas bubble content, so producing a faster-settling sludge.

The sludge from the farm was characterised in terms of its sedimentation properties, by observing its sedimentation behaviour in a 50-cm tube with 8 cm diameter. Settling characteristics are dependent on sludge concentration, so sludge samples were taken from the drum filters and the biofilter and diluted to give a similar sludge concentration. Under these standardised conditions the curves presented are comparable and reflect the inherent properties of the sludge rather than those associated with its concentration.

During the period of study, a feed trial was in progress on the farm. This involved using a blood-meal based material and the typical soya-based feed, for comparison. Figures 7A and 7B show an example of the results obtained. They compare the biofilter and drum filter sludge sedimentation properties. The biofilter sludge has a relatively rapid sedimentation, while the drum filter sludge, arising from fish fed on the normal soya-based feed, is slower settling, and the sediment is more diffuse. Drum filter sludge from the blood-meal based feed trial is also shown, with and without the experimental addition of iron. This curve showed much better sedimentation properties than the sludge produced from the soya bean-based feed trials. Good sedimentation was achieved with all samples, but the biofilter sludge settled faster (1.67 mm/s) than the drum filter sludge (1 mm/s). Diluted sludge settled more rapidly (rates greater than 3.3 mm/s).

Some problems of sludge sedimentation, including flotation, were observed, and were attributed to two variables: a) the amount of high-pressure water applied to the filter and b) the nature of the feed.

These results have led to a practical adjustment on the farm: the amount of water applied in the microsieve drum filter backwash jet-spray has been reduced from 0.75 l/s to 0.4 l/s, and the drum has been lowered further in to the effluent stream, with a rotation of 2 revs per min and 13.1 m² of submerged filter area. This represents an application of 16.7 ml/m²/s filtered surface area. The reduced water-application rate also solved the foaming (floating sludge) problem to a large extent.

Flotation of the sediment (sludge solids) was a greater problem with sludge derived from fish fed on soya-based feed, and far less a problem with the sludge derived from fish fed on a blood meal-based feed.

In summary, the properties of the un-concentrated sludge showed that there was considerable scope to further enhance the sludge concentration. Sedimentation of the sludges was rapid, and their properties, including high zeta potential in acid conditions (pH 6.8), suggest that additions of coagulant and flocculent could be used to enhance sedimentation (with an additional cost implication).

Improved sludge-thickening

The effectiveness of sludge capture by the drum filtration and sedimentation processes could be improved by optimising their operation. Hence research attention was also focused on the sludge-thickening process and its optimisation.

The biofilter sludge sedimented rapidly, and was thus relatively easy to concentrate by sedimentation. From the studies of the sludge flows and their characteristics it was apparent that the drum filter sludge stream had the most potential for concentration and that its handling was the most problematic. This problem was approached in two ways. First, the conditions of the drum filter process showed that the backwash rate of the drum could be reduced from about 1.17 l/s to 0.58 l/s. This immediately doubled the sludge solids concentration, from 125 to 250 mg/l. Second, the drum filter backwash was further concentrated fourfold by a sedimentation system capable of dealing with the continuous waste stream.

Using the characterisation information, an automated drum filter sludge-thickening system was designed and constructed. The system comprised a twin-tank batch-sedimentation system and was installed on the farm and commissioned (Figure 8).

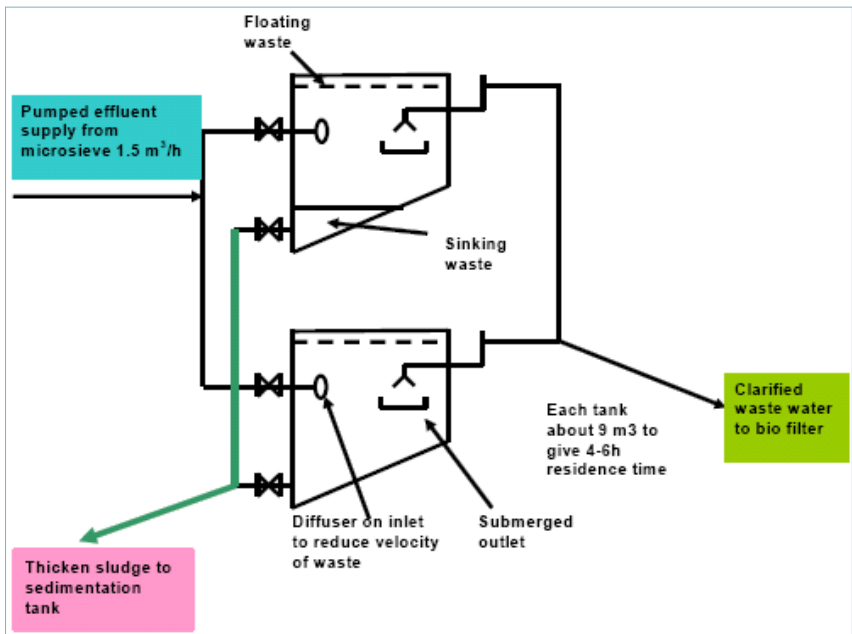

Figure 8 A: The sieve sludge sedimentation systems.

The diagram shows the basic principle of operation. As one tank fills the other tank is in a sedimentation phase. When the first tank is filled then the second tank is emptied. The sediments are sent to the sedimentation tank while the clarified water is pumped to the polishing filter. The roles of the tanks are then changed and so are cycled between sedimentation and filling.



Figure 8 B: The sieve sludge sedimentation systems.

The photo shows the fabricated equipment, each of the two tanks are 9m^3 in volume. The small box contains the control equipment including a PLC, relays and pneumatic control. A compressor is used to drive the pneumatic system that actuates the valves. The whole process is controlled by floating level sensors within the tanks which coordinate the emptying and filling of the tanks.

Two tanks are required: one tank fills while the other tank is in a quiescent, sedimentation, phase. When the first tank is full, the second tank is emptied. The thickened sediment flow enters the sedimentation tank while the clarified supernatant water is pumped to the polishing (bio)filter. The operation of the sedimentation system is designed to take the clarified supernatant from above the sediment and thus avoids the floating material at the surface. The system depends on a series of float level-indicators and sensors that control pneumatically-driven valves. The valves control the effluent flows to and from the tanks. The system is computerized and operates automatically.

The clarified supernatant from the drum filter sludge-thickener was then passed to a polishing biofilter. Clarified supernatant from the sedimentation tank was also put through the polishing biofilter.

The polishing biofilter was a concrete cylindro-conical vessel 2.5 m deep and 2 m in diameter, with a working volume of 6 m^3 and packed with a filter bed of (Kaldnes type) packing media. The packing occupied about 5 m^3 of the bed and was retained between stainless steel mesh at the base and at the surface. The system was aerated and this lifted and stabilized the packing against the top mesh. Effectively there was about 1.8 m depth of fixed packing during the filtration phase. During standard operation, the average cross-sectional velocity of the flow in the system was $<0.5\text{ mm/s}$. This is slow enough to allow small particles to be captured and adsorbed onto the surface of the fixed-bed biofilter media (Figure 9). The filter was cleaned by reducing the volume of water in the vessel so that the packing could now be thoroughly mixed when agitated by very high aeration. The dirty liquid could then be drawn off and pumped to the sludge pond (Figures 9 and 10).

The purpose of the polishing biofilter is to remove the fine particles from the system. Also, the filter removes some of the ammonia and leached organics from the sludge, and reduces the BOD₅, prior to the final release of the treated effluent into the lagoon.

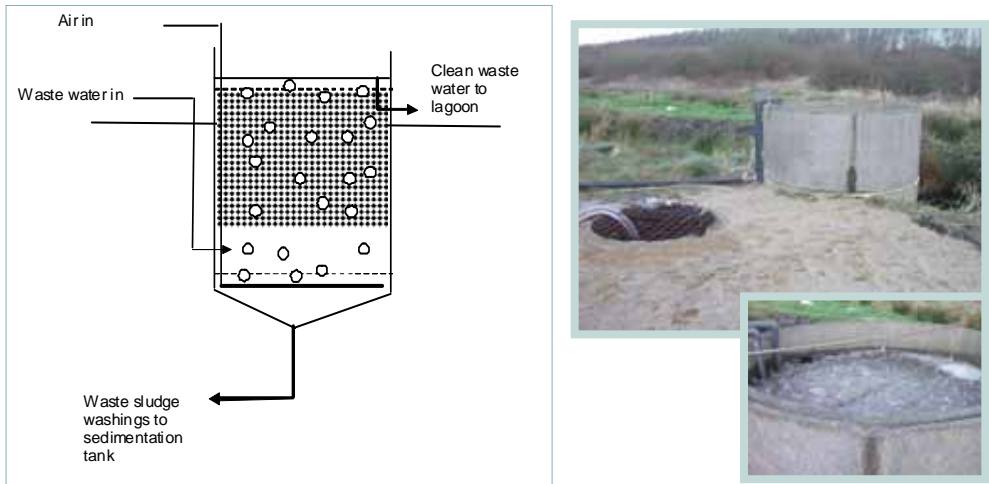

Figure 9: The Polishing biofilter. A. Diagram of the filter. B. Photograph of the biofilter with inset showing the top of the biofilter.

This unit receives clarified water from the sludge thickening process, from the sedimentation tank and from the sludge thickening tanks (shown at A in figure 8). The water enters the biofilter near the base (with an average particle size of about 5 micron and 10-40 mg/l SS) and is agitated by aeration. The water and the gas bubbles rise through the packed bed of biofilter media and clarified water passes out of the top and is released to the lagoon. The filter is washed on a weekly basis to remove accumulated sludge which is then passed back to the sedimentation tank. The primary role of the biofilter is to remove fine particles and a secondary role is to remove some soluble BOD. Refer to figure 1 for location on the farm.

The current configuration of the drum filter sludge-thickening system in relation to the key flows and solids content within the farm is shown in Figure 10 (see next page).

The treatment system was further optimized by the addition of iron chloride, FeCl_3 (5 mM or 280 mg/l Fe), to the microsieve drum filter sump. This enhancement has not been permanently implemented due to its additional cost. Further optimization is possible by modifying the computer control program to enhance the thickening.

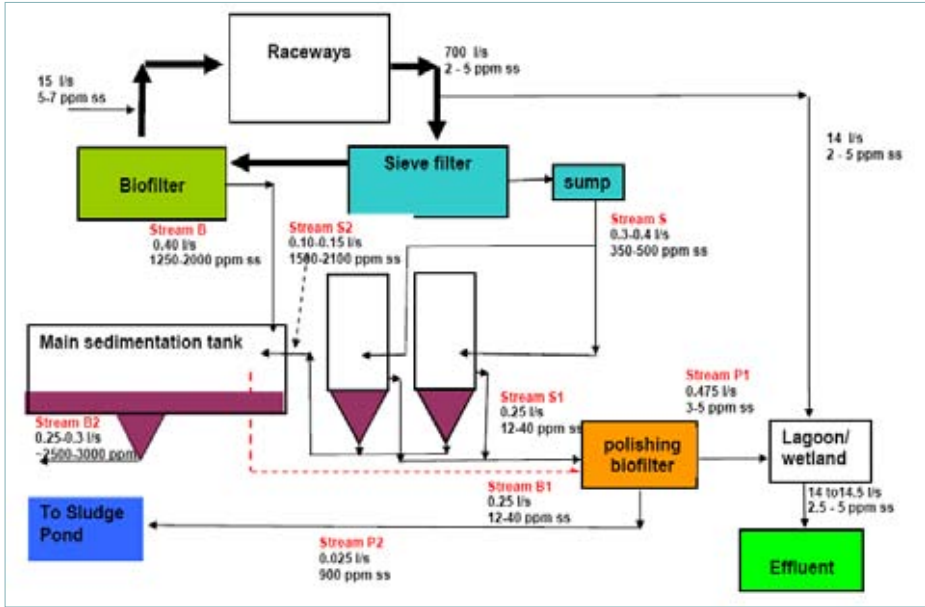

Figure 10: Overall configuration of sludge handling and waste water treatment at Højhoy. Note the labeling of the fluid streams. The details of these flows are shown in table 2. The diagram also shows the key flows and compositions of the flows within the farm.

Sludge- and water-handling

Table 2 shows the operation of the sludge thickening system without optimization. Configured and operated as described above, the microsieve drum filter sludge-thickener system removes about 97.3% (flows (S1+B1)/(S+B) in Figure 10) of the suspended solids in the effluent. The final product is a slightly turbid solution of solids with a concentration of about 40 mg/l. After the polishing biofilter, the solids content is reduced to about 0.2% of the total solids captured by the drum filter and biofilter (Table 2). Of the total solids flow 0.75 l/s (flow S+B in Table 2 and see Figure 10), the amount of water being put into the lagoon is about 0.48 l/s and the balance is passed to the sludge pond. There is scope to improve this further, by running more of the clarified liquid from the sedimentation pond into the polishing filter.

3. Improvements in farm performance and reduced environmental impact

During the AquaETreat project period, the farm operation was changed significantly. The recirculation flow was increased by lowering the pump head by about 10 cm; the drum filters were lowered to be 80% submerged; the jet-wash flow to the drum filter was reduced from 0.75 to 0.4 l/s; aeration

was added to the raceways, and increased agitation and flow resulted in improved removal of fermenting sediment from the raceways. The result was higher concentrations of solids in the drum filter backwash water. The operation

Table 2: Effects of the sludge-thickening system on wastewater clarification at Hojhoy.

Stream	Stream ¹	Flow ³ l/s	Suspended solids mg/l	Solid flow mg/s	% total solids
Sieve flow	S	0.35 ± 0.2	515 ± 75	180.25	23.0
Clarified flow from thickener	S1	0.25 ± 0.2	40 ± 6	10.0	1.3
Thickened liquid flow ²	S2=S-S1	0.10 ± 0.05	1910 ± 223	190.25	24.3
Biofilter flow	B	0.40± 0.2	1500 ± 350	600.00	77.0
Thickened biofilter flow	B2 = B+S2- B1	0.25± 0.1	3100 ± 700	779.00	99.8
Clarified flow sediment tank	B1	0.25	45 ± 6	11.40	1.4
Clarified polishing filter	P1 = S1+B1 -P2	0.475± 0.2	3 ± 1	1.25	0.2
Polishing-filter washings	P2	0.025	900 ± 330	22.50	0.4

1. See Figure 10 flow diagram for stream designation
2. Calculated by difference
3. Mean ± SD

of the sedimentation device, the drum filter sludge-thickening system and polishing biofilter (see below) finally releases about 0.48 l/s into the lagoon; the resultant sludge is thickened, but with little or no effect on the effluent water quality (dissolved solids).

Effluent water quality

The iron content of Hojhoy water is high (about 2 mg/l (ppm)). The stream flow is reliable and comes indirectly from spring water (rather than from run-off). The flow exhibits some seasonality.

In Denmark, the overall environmental impact of a farm is measured by the nutrients released into the water. Monthly samples must be taken and analysed to monitor the input and effluent of the farm for Total P, suspended solids,

ammonia, Total N and BOD₅. The changes in Total P, suspended solids, ammonia and Total N for the period of the AquaETreat research are shown in Figure 11. The current biofilter was commissioned in May 2004, prior to the beginning of the AquaETreat research at Hojhoj. Figures 11A-11D present the major water influent and effluent characteristics over a two-year period. The Figures show that in the initial stages prior to the installation of the current biofilter system, the water quality was relatively very poor (concentrations of all parameters prior to June 2004). A remarkable change was recorded when the biofilter was commissioned: all the farm outlet water quality parameters improved considerably. Total P, Total N and ammonia each declined significantly after the first six months of operation following commissioning. After this, the concentrations of these same three parameters were relatively low but showed a seasonal variation whereby the concentrations increased significantly in the spring and summer months, with rising temperatures. Concentrations were lowest in the winter.

Figure 11 shows some interesting water quality characteristics of the Hojhoj farm. Total P and suspended solids content in the effluent were the same as, or lower than, the influent water. This is despite the applications of feed (about 265 kg/day over this period) containing about 0.9% (9 g/kg) Total P.

This shows that there is considerable capture of phosphorous within the farm and that the effluent as measured by these parameters has little or no

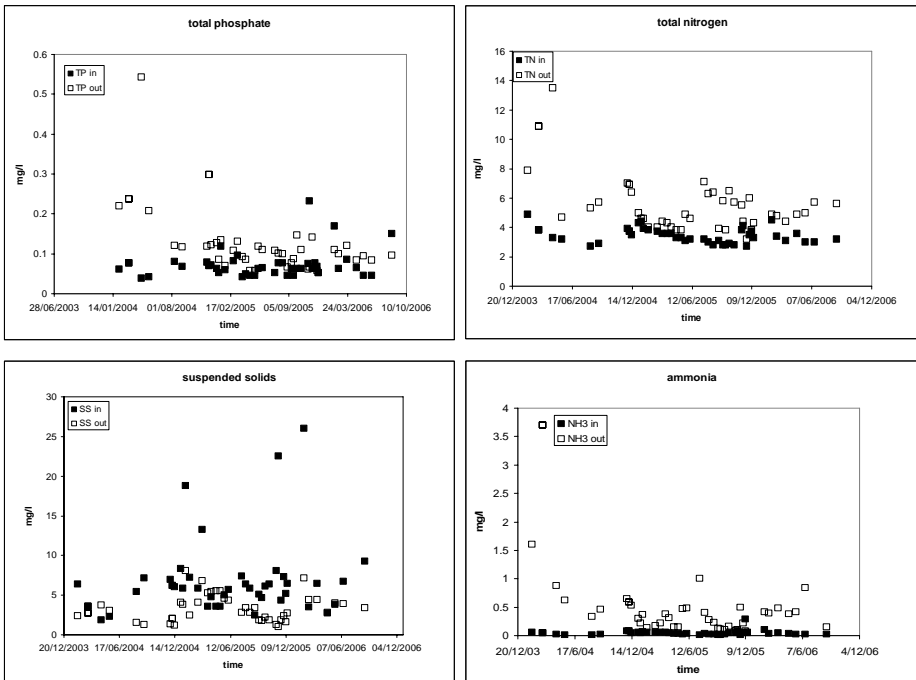

Figure 11: (A) Total phosphorous. (B) Total nitrogen. (C) Suspended solids. (D) Ammonia. Data source: required monthly certified monitoring. Water flow 15 l/s.

impact on the water course. This is not surprising, because phosphate is mainly bound to the particulates and the water, with high iron content, has potential for removing phosphate as a precipitate and as sludge. In contrast, the nitrogen content does increase significantly in the effluent compared with the influent.

Table 3 presents a summary of important water quality parameters, as a function of feed inputs. The Table provides an estimate of key components in the feed input into the farm together with those for input from the influent water. For all components, the concentrations show that considerable amounts are removed from the water, notably suspended solids, BOD₅ (91.7%) and Total P (96%) together with substantial amounts of ammonia (53%) and Total N (55%). However, the impact on the stream is considerable, with a large increase in the amounts of ammonia (0.19 - 0.38 mg/l increase) and BOD₅ (6 - 8 mg/l increase) in the effluent of the farm.

Table 3: Farm performance as measured by changes in water quality and removal of added feed components.

Parameter	Estimated Feed Input g/kg	Output g/kg feed ²	Output g/kg fish ³	Influent mg/l	Effluent mg/l	% removal of feed ⁴	% change in effluent water concentration ⁵
BOD	21441	112.7	119.9	1.5 - 2.0	6 - 8	91.7	400
SS	900	0	0	6.0 - 8.0	1.5 - 3.0	100	-52
NH ₃	60	32	34.1	0.01 - 0.02	0.2 - 0.4	53	2000
TN	68	37.6	40.1	3 - 4	4.5 - 6.0	55	50
TP	90	3.4	3.7	0.05 - 0.07	0.02 - 0.05	96	40

1. based on the composition of feed and the fact that it is all metabolized to carbon dioxide, water and nitrate. Biomar Ecolife 19 feed.
2. based on output per kg feed added
3. based on feed conversion ratio of 0.94
4. based on ratio of feed input and water output
5. calculated on the basis of the change in effluent concentrations compared with influent concentrations

Sludge-handling and the sludge pond

Fluids to the sludge ponds

Without sludge thickening and clarification of water, the quantity of liquid sludge leaving the farm and entering the sludge pond is about 65 m³ per day (23,725 m³/year); and has an average concentration of solids of 780 mg/l. The sludge pond has a liquid residence time of 14 days. After soak-away, the sludge concentration is 80-90 g/l. With the sludge thickening system now in place, the liquid flow to the sludge pond is reduced to 26 m³ per day (9,490 m³/year). Hence, on an annual basis, the sludge flow from the farm is reduced from 23,725 m³ to 9,490 m³, with 14,235 m³ going to the sludge lagoon. The residence time rises to 40 days with an average sludge solids concentration of 2.5 g/l. With the treatment system now in place, there is scope within the farm for thickening the sludge further whilst retaining its handling properties (up to 25 g/l remains easily pumpable). At Højhoy it is therefore realistic to consider reducing the volume fivefold, to 12.5 g/l. At this concentration, the sludge water flow would be about 1,900 m³/year and the residence time more than 170 days. At this residence time, anaerobic digestion would reduce a substantial proportion of the sludge to methane, with phosphate concentrating in the residue. This is a potential resource for the recovery of farm-derived phosphate.

Disposal of sludge

In the current Danish situation the economic use of sludge is limited. The flow of dry sludge per year is about 24 tonnes. Considering the input of feed this is low, and is attributed to oxidation of the sludge in the biofilter. Compare this with the situation in the pond where the sludge is actively methanogenic, and considerable biogas is produced which, from published work on salmon hatchery effluents, amounts to about 75% of the sludge. If 75% of the solids from the sludge at Højhoy are digested, the solids would be reduced to about 6 tonnes per year. With the rapid and effective anaerobic digestion occurring in the sludge ponds, disposal costs are those for excavation of the sludge from the pond, approximately once every 3 years (hire of a digger plus man for 2 days). Over three years this would give about 18 tonnes of dry sludge. Assuming 40% solids, a volume of about 45 m³ of concentrated sludge would be available to spread out over an equivalent area of pond (around 300 m²) and would give a sludge layer 10-15 cm deep. If the sludge were left to dry, it would oxidize further.

The reduction in sludge volume during anaerobic digestion causes the solid components to be concentrated further. This will also increase the concentration of insoluble components, such as iron phosphate. Further investigations will be made to confirm the composition of residual solids in the ponds. The analysis of raw sludge suggests that some of the heavy metals (including zinc) may become a problem. The solids remaining are mainly inorganic materials containing high concentrations of iron phosphate (FePO₄) which, at the neutral pH of the sludge pond, remains tightly bound to the solids. Its concentration may be as high as 25%. There is potential for

recovering significant amounts of phosphate from this solid. The recovery process is rather complex and would be expensive to achieve.

The possibility of biogas production from the farm effluent is considerable, and efficient conversion of purified gas into electrical energy could provide up to 10% of the power required by the farm. However, the costs need to be estimated and the energy conversion to electrical power has to be investigated. Studies have shown that effective biogas conversion requires substantial investment and the quantities of gas produced on the farm do not justify the investment required at present costs. The farm would need to be at least a factor of 10 larger for this option to be considered even marginally economic.

4. Discussion and Conclusions

Costs

The costs of design and operation of the system, installed as described, were as follows:

Tanks for the thickening system and the installation of the polishing biofilter for Hoghoj were €65,000. Calculated on the basis of a 10-year depreciation period, the annual cost including labour was about €11,175 per year. This cost relates to a research installation. The same arrangement could be achieved in a commercial environment for about €8,000 per year by using concrete construction materials.

The most significant costs are associated with additional labour at €4,000 per year (130 h @ €30/h). The most significant improvement in the design would be to install the drum filter sludge-thickening system closer to the biofilter and install it to achieve gravity flow to the drum filter. In a commercial installation the costs could be reduced considerably by burying the system to enable gravity flow to predominate, and constructing it in concrete.

The sludge pond is 5 m higher than the sedimentation tank. Therefore, pumping incurs a cost and it is estimated that 3,500 kWh per year are used in pumping water to the pond. With the reduction in liquid flowing to the pond this will be reduced to 1,500 kWh per year.

The main running costs for effluent treatment are associated with the cleaning of the biofilters. On average, this takes about 8 hours per week, or a total of 400 h per year. This is in addition to the costs given above.

In total, the cost of labour associated with effluent treatment activities at Hoghoj is about €16,000, equivalent to €0.106 per kg fish produced. Reducing the biofilter washing time has a significant impact on costs. Moving-bed biofilter designs have the advantage of little or no labour costs in their operation.

Further improvements and considerations

Manpower and water-saving biofilter washing vs more effective sieving

Effluent treatment costs can be significantly reduced by minimising the manpower required. Improving the effectiveness of the drum filter would reduce the need to wash the biofilter so frequently. At Hojhoy, the first goal is to reduce the time washing the biofilter; i.e. to wash at the same frequency but only twice, not three times, thus reducing cleaning time to five hours per week. A second stage would be to reduce the cleaning frequency, so reducing cleaning time by a further 20%. This would reduce labour costs for cleaning to €8,000. This solution would also reduce the amount of water to be treated.

An alternative to changing the management of the current biofilter is additional investment to automate the cleaning process or to convert the fixed biofilter to a moving-bed filter.

Environmental impact

The recirculation system used at Hojhoy, in conjunction with the lagoon treatment of the water and the capture of the sludge, results in the environmental impact from the additional nutrient added in the feed being largely captured (in the fish or in the sludge). Removal of BOD₅ and capture of phosphate are particularly effective. Nitrogen is still a problem; only 50 - 60% of the nitrogen in the effluent is removed. This is typical of the model recirculation fish farms in Denmark. Further innovation in technology will be required to reduce the nitrogen content of the effluents. This represents a considerable challenge. Constructed wetlands could offer a practical solution to nitrogen management.

Appendix

Table 4: Elemental analysis of waters and sludges from Hojhoj: stream water, microsieve drum filter and the biofilter1

	Filtered stream water ²	Biofilter Suspended Solids 1113 mg Total N 34.31 mg		Sieve Suspended Solids 54 mg Total N 5.51 mg			
	Water mg/l of waste water	Water mg/l of waste water	Sludge mg/l of waste water	Sludge mg/kg of solids-dw	Water mg/l of waste water	Sludge mg/l of waste water	Sludge mg/kg of Solids-dw
Sn			0.03255	29.245		0.0042	54.6
S	8.367	8.944	3.4679	3115.77	9.12	0.2944	3873.03
P		0.0944	22.54	20151.57		1.9795	26046.05
Y	0.0002		0.0286	25.65	0.0001	0.0005	6.58
Cu	0.0047	0.0039	0.1168	104.94	0.0067	0.0013	17.1
Si	3.747	2.924			3.224		
Co		0.0095	0.0199	17.84		0.0005	5.92
Mg	5.37	5.49	1.8308	1644.92	4.756	0.1424	1873.03
K	2.766	4.604	4.018	3609.61	2.418	0.263	3460.53
Mn		1.07	2.245	2017.07			
Ca	29.04	31	22.51	20224.62	29.19		
Pb			0.00715	6.42			
Sb							
Fe		0.3188	71.73	64446.99		4.05	53282.9
Mo					0.0084		
Cr	0.0011					0.045	592.1
Ti			0.1008	90.52			
Ni							
As	0.017	0.0092	0.0159	14.29	0.015	0.0006	7.24
Na	17.473	19.313			15.95		
Al	0.0037	0.0059			0.0046		
Zn	0.0077	0.0303	1.333	1197.66	0.0046	0.463	6092.1

The Table shows mean values.

Blank cells indicate elements below the detectable limits of the system and not significantly different from the background concentrations

1. Analysis by ICP-AES
2. Prior to filtering the water contained 2.2 ppm (mg/l) iron which was removed using Whatman GFC filter paper (0.6 µm)

7. Case Study: Maribrin

V. Zonno, G. Bressani, R. Acierno and S. Vilella

1. Farm description

Maribrin srl was established in 1997, to manage the land based intensive fish farm, built in the late eighties by the Cooperativa Ittica Sud. The fish farm is located on the Adriatic coast of Apulia Region (Italy), 8 km south of the city of Brindisi.

The main species reared in the farm are the Mediterranean Sea Bass (*Dicentrarchus labrax*) and the Gilthead Sea Bream (*Sparus aurata*). Both species are reproduced in the hatchery using broodstock caught in the surrounding area or selected from within the farm.

The pre-growing period, which normally lasts one year, is followed by the on-growing phase during which the fish reach market size at 250-1000 g. These two phases last from 18 to 36 months.

Pre-growing and on-growing take place in concrete tanks using sea-water pumped from the adjacent coast and from a series of deep wells. The quality of sea-water is high and constantly controlled by monitoring several chemical, physical and microbiological parameters. An important characteristic of the sea-water from the wells is the constant temperature at 24°C, the optimum for rearing Sea Bream and Sea Bass. Using this water gives high growth rate during the winter and an ideal situation in summer.

The fish are fed a commercial extruded feed, with composition and pellet size matched to the size of the fish. At harvest, the fish are boxed and iced before being transported to market. Almost all the farm production is sold through retailers operating in the South of Italy.

Maribrin product is easily recognised thanks to the farm traceability program: every fish is sold with a distinctive label inserted in the gill operculum, carrying a logo and other details, such as species, production system and location. Quality and traceability allow the fish from Maribrin to be sold at higher prices compared to fish from other farms which are mainly imported. A target market is the quality restaurant sector.

The farm has a total production of 200 tonnes/year with 80% Sea Bass and 20% Sea Bream. Overall feed conversion rate (FCR) is around 2:1. Minor experimental quantities of other species: Sharpsnout Seabream (*Diplodus puntazzo*), White Seabream (*Diplodus sargus*), Eel (*Anguilla anguilla*), Dusky Grouper, (*Epinephelus guaza*), Meagre (*Argyrosomus regius*) have been grown at the site.

The farm consists of two main sectors: the hatchery and the out door tanks. The Hatchery is located in an industrial building of 1600 square metres, and has the following units: brood stock maintenance and induction; live feed production unit with separate areas for algae; rotifers and Artemia production; larval and post-larval rearing and juvenile rearing unit.

Every hatchery tank can receive three different types of seawater through separate pipelines: filtered seawater, filtered and sterilised seawater and deep well water at salinity ranging from 30 to 38ppm, and constant 24°C. Each tank has a separate supply of air and oxygen. Oxygen level is remotely controlled via computer and alarms are activated in case of problems.

There are 50 out door concrete raceways, in two parallel rows, of 3 different sizes: 4 tanks of 50m² for juvenile rearing, 20 of 100m² for pre-growing and 26 of 200m² for on-growing. The total rearing volume is about 7,000 cubic meters. Water is distributed to the raceways through two separate pipelines: the first supplies 70l/s of seawater, with temperature a range from 10 to 29° C, pumped from the adjacent coast and the second brings 300l/s of seawater, pumped from 5 deep wells, at a constant 24°C.

In each raceway, there is a potential total water renewal every 8 hours. Every holding unit is equipped with oxygen supplementation and measuring probes for automatic remote control. With this system the oxygen level in the unit can be maintained near saturation while acoustic and visual alarms are activated in case of emergency.

The farm also has facilities for ice making, fish packing and refrigerated storage, a laboratory for some analysis, a feed storage area, three generators with total capacity 500KVA, offices and meeting room, maintenance and logistics facilities.

The farm is managed by a director with the help of two biologists, one full time and one part time and 11 full time workers and three seasonal workers. A veterinarian is also retained.

2. Farm effluent management before installing the AQUAETREAT System

Effluent water from the various sectors of the farm flows through a concrete channel located between the two rows of raceways. From this channel, the effluent passed into two earth ponds, or lagoons, of about 12 hectares, where partial sedimentation occurred, and was then discharged to the sea. Before the AQUAETREAT project there was no other treatment for the waste water at the farm.

3. Inlet water and effluent characterisation

Prior to installing a water treatment system, the fish farm characteristics were assessed in relation to: rearing methods, species grown, and water flow. Physical and chemical water analysis was made at different points of the farm and some and the phyto- and zooplankton present in the lagoon were identified.



Figure 1: Schematic view of Maribrin outdoor rearing tanks

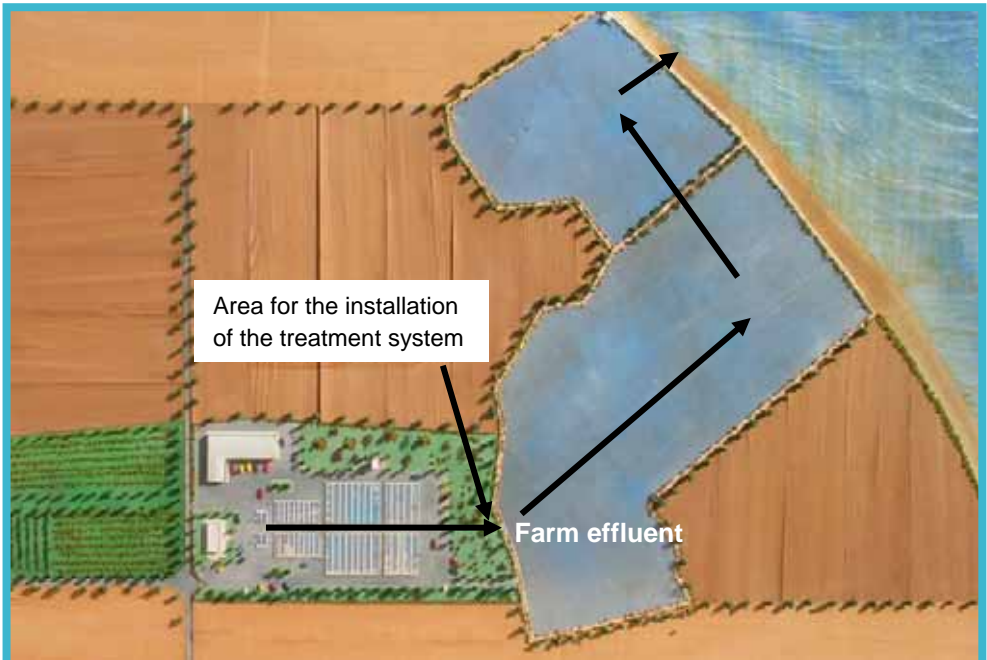

Figure 2: Schematic view of Maribrin site with the lagoons and indicating effluent flow

Analysis was carried out during September-November 2004, noting changes of influent and effluent water quality through the day in relation to the routine farm activities. Tables 1 and 2 show the results of physico-chemical analysis (water and sediments).

Table 1: Comparison between inlet and outlet water quality at the farm. Figures in brackets the authorized limits for aquaculture effluent in Italy

	pH	SS (≤ 80 mg/l)	Ammonia (≤ 15 mg/l)	Nitrates (≤ 20 mg/l)	Nitrites (≤ 0.6 mg/l)	Phosphates (≤ 10 mg/l)
Inlet	6.8	5.8	0.32 \pm 0.07	5.32 \pm 0.94	0.107 \pm 0.003	0.058 \pm 0.01
Outlet	6.6	40	0.71 \pm 0.35	1.11 \pm 0.041	0.516 \pm 0.035	0.202 \pm 0.025

Table 2: Physico-chemical characteristics of the effluent at the outlet of the lagoon

Parameters	Effluent	Lagoon	Measurement units
SS	39.65	114.5	mg/l
biochemical analysis			
Phosphates	0.202	0.012	mg/l
Nitrates	1.11	0.505	mg/l
Nitrites	0.516	0.12	mg/l
Ammonia	0.71	0.1	mg/l
chemical analysis			
pH	6.6	6.8	
salinity	35540	36015	μ S/cm
BOD	330	370	mgO ₂ /l
organic carbon	27.68	36.48	mg/l
heavy metals			
Cadmium	<0.00009	<0.00009	mg/l
Lead	<0.00090	0.08	mg/l
Copper	0.35	0.036	mg/l
Nickel	<0.00027	<0.00027	mg/l
Zinc	<0.00009	<0.00009	mg/l
Iron	<0.00009	0.03	mg/l
Mercury	<0.0012	<0.0012	mg/l
PAH	<0.005	<0.005	mg/l
PCB	<0.01	<0.01	mg/l

Analysis of data produced two conclusions:

1. Overall quality of the farm effluent before entering the lagoon is good.
2. Solids are accumulating in the lagoon under anaerobic conditions and bioremediation is very limited. No work had been done on assessing what area was necessary for sedimentation or for bioremediation. This conclusion is confirmed by Table 3 which shows the characterisation of lagoon sediment.

Table 3: Chemical and biochemical characterisation of lagoon sediment

Parameters	Soil from floor of lagoon	Measurement units
<i>chemical analysis</i>		
pH	7.25	
Dry Matter	73.18	%
BOD	3276	mgO ₂ /gVSS
organic carbon	10.5	g/Kg D.M.
<i>heavy metal</i>		
Cadmium	<0.09	mg/Kg D.M.
Lead	7	mg/Kg D.M.
Copper	32	mg/Kg D.M.
Nickel	8.7	mg/Kg D.M.
Zinc	<0.09	mg/Kg D.M.
Iron	5700	mg/Kg D.M.
Mercury	<0.34	mg/ Kg D.M.
PAH	<0.0001	mg/Kg D.M.
PCB	<0.0001	mg/Kg D.M.

The tables show that the content of organic matter and some heavy metals (lead, copper, iron) are higher in the lagoon sediment than in the effluent water. This is due mainly to run off water from surrounding agriculture but also because the solid particles, transported by the outlet flow from the farm, have been accumulating in the lagoon, over a long period.

To be able to compare the effect of water treatment on the general quality of the effluent, the phyto-zooplankton population was assessed at two points in the lagoon. Surveys were made before installation of the treatment system and again one year later. Increased biodiversity was found, a wider range of species is present and they are found in greater numbers.

4. Description of system chosen

Study of the farming methods and water characteristics lead to the choice of the treatment system. In between the intensive rearing tanks and the lagoon are two unused earth ponds. It was decided to install the system close to this area to allow these ponds to be used.

The system installed used a drum filter for primary filtration and then passed the resultant backwash water (sludge) through a flocculation and coagulation process step. The sludge was then directed either to a geo-tube (7), to a conical filter (8), or to a belt filter (9) to assess the effectiveness of the three processes. Cleaned water from this stage was passed to a wetland (5). This is shown in Figure 4.

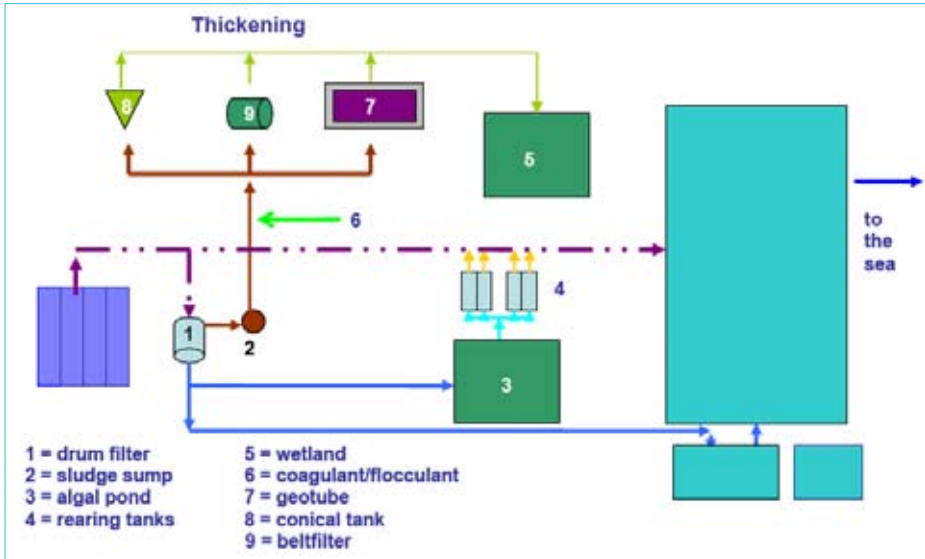

Figure 4: A schematic view of the treatment system

5. First filtration through drum filter

The size of drum filter chosen is able to treat one third of the total farm effluent (80-100 litres/second): the remaining untreated water goes to two earth ponds (lagoons) of about 12 hectares, where a partial sedimentation occurs, and is then released through an outlet to the sea. During the experimental phase, in 2005, the drum filter was tested with screen mesh sizes of 60 and 90 microns to establish solids removal efficiency (Figure 5).

During initial trials, with effluent water containing 40mg/l SS, the drum filter removed 43% of SS when fitted with 90 micron mesh screens, and 54% when fitted with 60 micron mesh. During further trials, the 60 micron mesh screens were used, achieving higher concentrations of solids in the backwash water without causing blockage of the screens.

The filtered water is released into an algal pond connected to a small lagoon

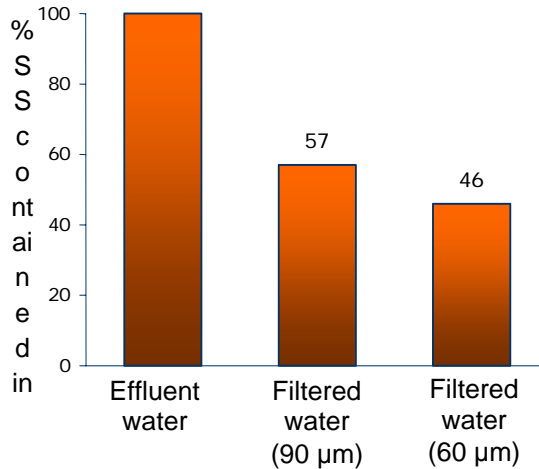

Figure 5: Reduction of SS in the effluent water by mechanical filtration

which does not receive water from other sources.

This mechanical filtration produces a flow of filtered water, where the reduction of SS varies between 30 and 70%, and a very low flow of approximately 5000 litres per day of sludge containing around 1 gram of suspended solids per litre from the backwashing of filter. This initial filtration gives sludge with a SS concentration 50-80 times higher than the farm effluent SS concentration.

6. Sludge thickening system

The filter is effective but the sludge still contains around 99% water, which precludes any economic disposal or eventual re-use. The sludge was piped to a fibreglass tank, Figure 6, where coagulant and flocculant was added before the sludge was pumped to one of the following treatment steps:

- sedimentation in a conical tank;
- geo-tube filtration;
- belt filtration.



Figure 6: The sludge conditioning tank

Before treatment with coagulant and flocculant, the sludge was characterised in terms of its sedimentation properties by observing sedimentation in a graded cylinder with a volume of 200ml. A problem in the sludge sedimentation was the presence of floating material caused by the incorporation of fine bubbles from the high pressure screen backwash water. It was minimised by reducing the pressure of the backwash water.

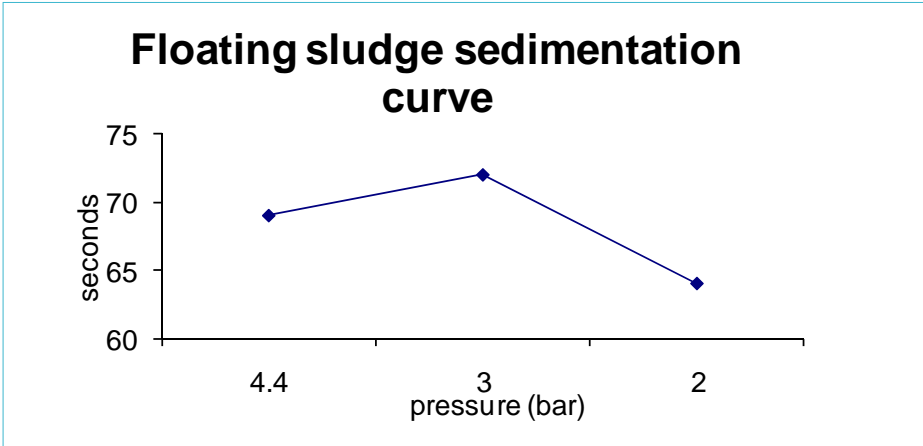

Graph 1: Floating sludge sedimentation rate at different backwash pressures

7. Coagulation and flocculation process

The backwashing of the filter produces waste water with approximately 1g/l of SS. The volume of this sludge is 5m³/day, or approximately 1500m³/year. In order to separate the SS from the water and then to progressively thicken the sludge, several types of coagulants and flocculants were tested.

Experiments showed that the best results were obtained using 1ml of 13% FeCl₃ solution, as coagulant, and 2ml of 1% diluted solution of the cationic polymer DREWLOC 2488, obtained from ASHLAND, per litre of waste water. The reagents gather the small particles into larger size particles, or floc, that are heavier and sediment easily.

The coagulation and flocculation reagents were dosed, by separate metering pumps, directly into the collecting tank receiving the drum filter backwash wastewater. An exact volume of iron chloride was added to the sludge timed to coincide with each drum filter backwash cycle, while the flocculation reagent was added just before the transfer of sludge to the final thickening device.

8. Sludge thickening with geo-tubes

Use of geo-tubes, Figure 7, for sludge treatment was tested on a laboratory scale and in the field. On the farm, the geo-tube was tested with the wastewater from the collection tank.

The tube was laid out supported by wooden pallets. Water filtered through the fabric of the geo-tube and the sludge remained inside the tube.

Figure 7: The geotube before filling



Tests confirmed the expected results: the geo-tube was able to remove up to 60% of the solids present in the sludge and the efficiency of solids removal was improved with a preliminary coagulation and flocculation process.

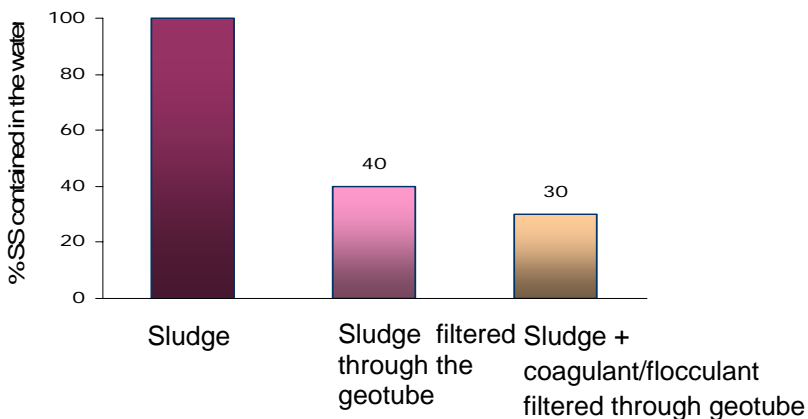

Graph 2: Reduction of SS in the sludge using geotubes

Despite the effectiveness of the geo-tube for sludge thickening, using this system on the farm is not practicable until methods are developed for handling and transport of the geotubes filled with sludge.

9. Sludge thickening with conical sedimentation tank.

Wastewater was delivered to the conical tank, Figure 8, through a pipe discharging at the water surface in the centre of the tank to avoid disturbance to the settling of the SS. The supernatant leaves the tank at the water surface at the circumference to return to the drum filter. Sediment is periodically flushed from the base of the cone.

Dewatering of the sludge with this conical tank was not sufficient and the sludge developed bad smells due to the formation of volatile substances.



Figure 8: Conical tank

10. Sludge thickening with belt filter.

The belt filter used at Maribrin acts as a gravity sludge thickener. It has a filtration screen in the form of a conveyor belt. The solids are collected on the upstream face of the belt, a polyester band with 400 micron mesh, while clarified water passes through the belt to the filter outlet.

The sludge is gently lifted out of the water as the belt moves upwards towards the belt scraper. The belt moves intermittently, controlled by a water level probe, and the speed of movement belt is controlled via a frequency converter. Thickened sludge is scraped from the belt into a tank from which it may be pumped for storage or reuse. A pressurized water backwash system is used to rinse the screen belt after sludge removal. The process is assisted by the concentrated sludge being exposed to air while in a thin layer on the belt. The belt filter at Maribrin produced 30-50kg/day of sludge thickened to 25% dry matter. This was the highest level of de-watering achieved.

Figure 9: Thickened sludge with belt filter



11. Data on sludge characteristics

Below, in Table 4, are the analysis results of sludge samples, obtained at the farm through mechanical filtration and thickening devices.

Table 4: Physico-chemical characteristics of the sludge

Parameters	Sludge Contents	Measurement units
<i>chemical analysis</i>		
pH	7,25	
Dry matter	13 - 25	%
BOD	6140	mgO ₂ /h/g VSS
organic carbon	14.125	%D.M.
Total nitrogen	39235	%D.M.
Chlorides	86 - 187	g/KgD.M.
Potassium	12	g/KgD.M.
Calcium	29	g/KgD.M.
Magnesium	10	g/KgD.M.
<i>heavy metals</i>		
Cadmium	<0.09	mg/KgD.M.
Lead	<0.09	mg/KgD.M.
Copper	156.5	mg/KgD.M.
Nickel	8.25	mg/KgD.M.
Zinc	205.5	mg/KgD.M.
Iron	1075	mg/KgD.M.
Mercury	<0.34	mg/KgD.M.
PAH	<0.001	mg/KgD.M.
PCB	<0.001	mg/KgD.M.

Analysis of data shows that the content of dry matter in the sludge varies between 13% and 25 %, depending on the number of process steps used in the thickening system and the combination of coagulation and flocculation. Organic carbon and total nitrogen content is comparable with values found for other animal or urban waste.

The high level of Fe metals can be associated with the addition to the waste water of Iron Chloride coagulant, containing other trace metals, as one element of treatment.

The conclusions from this work are:

1. Analysis of numerous wastewater and thickened sludge samples, obtained using different systems and flocculation reagents, confirmed that the final sediment, contained carbon, nitrogen, potassium, and calcium; as expected, the concentration of chloride is very high;
2. The presence, due in part to the addition of the flocculation and coagulation chemicals, of minerals such as iron, zinc, copper and magnesium, is also significant in raising the value of the thickened sludge for use as fertiliser.
3. The levels found of inorganic solids (sand) is not relevant and depends on weather conditions and in-let water characteristics. Very high sand content can interfere with flocculation.
4. The work confirmed the absence of potential pollutants, such as heavy metals, poly-aromatic hydrocarbons, PCBs, and pathogens.
5. The characteristics of the sludge make it suitable for agronomic use, according to Italian law.

12. Biofiltration using an algal pond and re-use of treated water

Algal ponds, in particular high rate algal ponds (HRAP), represent a useful approach for dissolved nutrient control in marine wastewater. Macro algae, chiefly *Ulva* sp., and also micro algae, absorb the dissolved elements (N, P, C) under the combined influence of light and temperature.

HRAP, even at this early stage of development, appear very efficient with a mean purification of 70% of inorganic nitrogen and 52% of inorganic phosphorus, both of them dependant on temperature and daylight. In optimal conditions the purification rate can reach 95% for nitrogen and 85% for phosphorus. Due to the photosynthetic processes that occur in the HRAP, water that leaves the ponds possesses high oxygen concentration and slightly reduced pH, both conditions very favourable for water recycling in the rearing processes. Algae can be used as raw material for food or by the pharmaceuticals/cosmetic industry or to produce, directly or indirectly, food for human consumption: molluscs, herbivorous and carnivorous fishes.

A flow of 40l/s of the water from the drum filter was discharged to the unused ponds close to the filter. The purpose was to assess using water after "biofiltration" in this pond. Part of this water, 10 l/s was used to rear Sea Bream. The effect of using treated effluent on fish quality and welfare was evaluated by checking the growth performance of the fish and by measuring

specific markers of the nutritional and physiological state of animals. During the trial, conducted between May and September 2006 the nutritional and physiological state was assessed, at the beginning and at the end of the experiment, by measuring indicators of the gastro-intestinal tract; alkaline phosphatase, leucine-amino peptidase and Na/K ATPase, and liver functionality via anti-oxidant enzymes, Na/K ATPase. Cortisol blood plasma concentration was measured and intestinal morphology modifications were analysed by the observation of histological sections. Parallel analysis was conducted in sea breams reared under controlled conditions.

Results indicate that Sea Bream reared using treated effluent have better growth performance and higher survival when compared with control fish. Control fish showed significantly higher values of markers for stress such as cortisol concentration and antioxidant enzymes activity and had damaged intestinal mucosa, Figure 10.



Figure 10: Hystologic section of intestinal tract of fish reared with treated water (A) and control well water (B)

13. Conclusions

The results obtained suggest that re-use of farm effluent, after treatment with mechanical filtration and in an algal pond, is a useful tool for water use optimisation in land based marine aquaculture and allows the production of high quality fish, while maintaining animal welfare.

The analysis of phyto-zooplankton in the algal pond showed also a quantitative and qualitative increase in biodiversity.

8. Case Study: Murgat

E. Roque d'orbcastel and J.P. Blancheton

1. Description of the farm

Charles Murgat SA fish farm (www.charlesmurgat.com) is located at Beaurepaire, Isère, in southeastern France. The farm is operated as a flow-through system and produces on average 600 tonnes of Brook Trout (*Salvelinus fontinalis*), Brown Trout (*Salmo trutta fario*), Rainbow Trout (*Oncorhynchus mykiss*) and Arctic Char (*Salvelinus alpinus*) per year. The average standing stock is 160 tonnes, corresponding to a fish stocking density of about 60 kg/m³.

The on-growing unit is divided into two sectors (Figure 1):

- sector 1 consists of seven concrete raceways (each 70 m x 6 m x 0.8 m deep) with four species reared from 50 g to more than 2 kg (55-70% harvested at 200 g);
- sector 2 consists of two concrete raceways, with only Rainbow Trout from 200 g to 1 kg (50% harvested at 500 g).

Both sectors are operated with high quality and constant temperature well water (around 11 °C). In the first three tanks (raceways) of sector 1, the water flow rate varies from 600 l/s to 2000 l/s, corresponding to a water renewal rate between

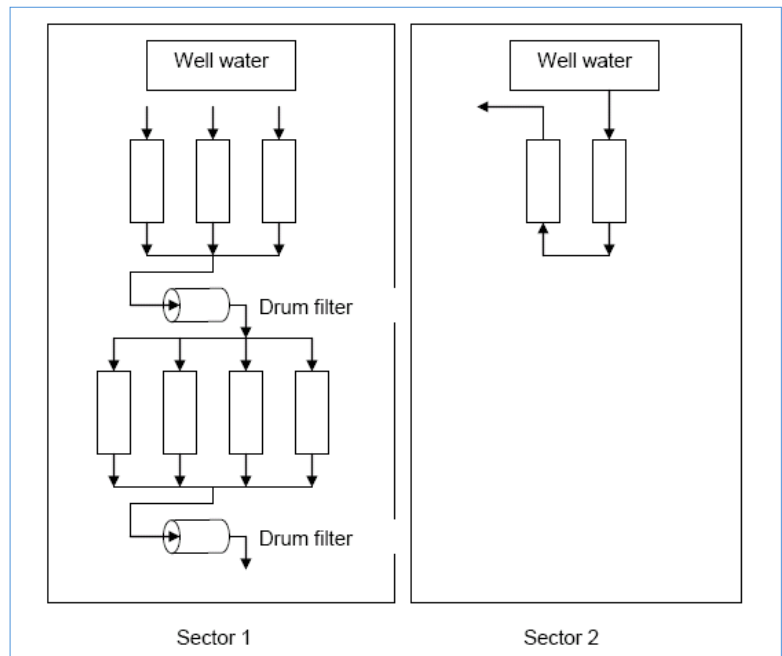

Figure 1: The on-growing unit of Murgat farm, divided into two sectors

200% and 600% per hour per tank. After first use in the three raceways, the water is filtered through a mechanical drum filter, oxygenated and used again in the four following raceways of the sector. The effluent of that sector is filtered with another drum filter before being released into the river through a sport fishing area.

The two raceways of sector 2 are fed with well water, with a flow rate varying around 500 l/s.

2. Characterisation of the farm effluent

The AquaETreat Project included on-farm verification of a method for predicting waste fluxes from fish culture by comparison with data obtained from sampling and analysis of actual waste from the farm.

Quantitative characterisation

The methods used to quantify fish culture wastes are based either on feed digestibility (nutritional approach) or on the analysis and evaluation of dissolved and suspended-solid wastes produced by the fish (hydro-biological approach)¹. Both methods were used in order to evaluate the wastes produced by the farm². The daily flux of wastes, predicted with the nutritional method and measured with the sampling method, are presented in Table 1.

Table 1: Comparison of predicted and measured daily waste production of the whole farm. For further explanation, see text

Parameter	Flux (mean values)			
	Predicted (kg/d±SD)	Predicted (g/kg feed/ d±SD)	Measured (kg/d±SD)	Measured (g/kg feed/ d±SD)
Total N	59.8 ± 6.0	42.58 ± 0.38	54.1 ± 10	38.5 ± 7.1
Particulate-N	10.1 ± 1.0	7.21 ± 0.02	11.8 ± 3.4	8.4 ± 2.4
NH4-N	39.7 ± 4.0	28.3 ± 0.3	31.6 ± 7.5	22.5 ± 5.3
Urea-N	-	-	10.7 ± 2.5	7.6 ± 1.8
Total P	6.33 ± 0.6	4.51 ± 0.11	13.6 ± 3.5	9.7 ± 2.5
Particulate-P	-	-	9.6 ± 3.6	6.8 ± 2.6
PO4-P	-	-	4.0 ± 0.2	2.8 ± 0.1
Suspended Solids	206.5 ± 20.7	147.0 ± 0.2	317.8 ± 165.7	226.2 ± 117.9

The differences between the 'Predicted' and 'Measured' results in Table 1 can be explained by the different sensitivities of the methods:

- the nutritional method depends on the digestibility of feed ingredients and on the quantity of feed eaten

- the hydro-biological method relies on sample preservation and the precision of flow-rate measurement. The physical properties of the solid wastes, subjected to sedimentation and re-suspension due to fish harvesting, tank cleaning or hydrology also have a strong impact.

Both methods give similar waste production values when expressed per tonne of fish grown (147.5 kg for suspended solids, 40.8 kg for N, and 8.7 kg for P).

Qualitative characterisation

The sampling method provides some detail on the different forms of nitrogen and phosphorous fluxes:

- 21% of nitrogen wastes are present as particulate-N, 59% as ammonium-N ($\text{NH}_4\text{-N}$) and 20% as urea-N
- 68.8% of the phosphorous wastes are in the particulate form and 31.2% are dissolved $\text{PO}_4\text{-P}$ (Figure 2).

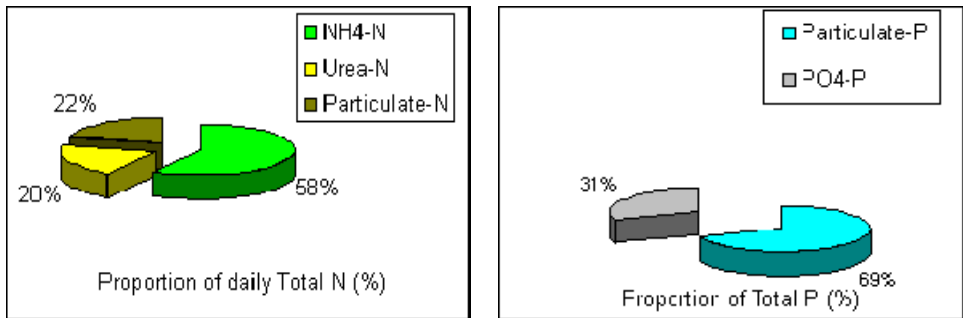

Figure 2: Forms of Nitrogen and Phosphorous in Murgat effluent (% of total N and total P produced by fishes by day)

3. Effluent treatment system

System description

The system in use at the farm (Figure 3, see next page) is composed of three mechanical filters, one in the pre-growing unit sited adjacent to the main farm and two in the on-growing unit, and primary and secondary effluent thickening systems.

The effluent from the pre-growing tanks is filtered through a first drum filter (Figure 4, see next page).

After first use, the rearing water of the first tanks of the on-growing facility is filtered through a mechanical filter, oxygenated in a low head oxygenator, and used again in the four following tanks of sector 1. The effluent of those tanks is filtered with another drum filter before being released into the river through a

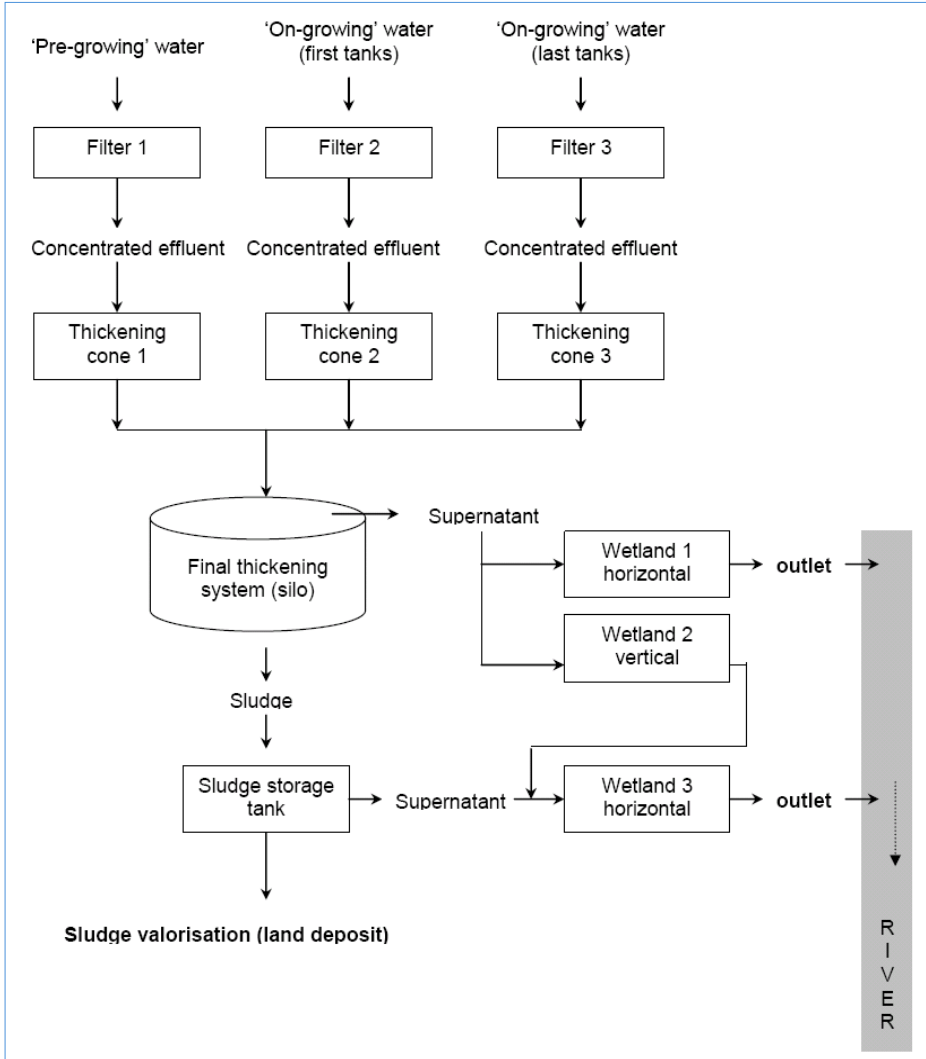

Figure 3: Murgat farm effluent treatment scheme



Figure 4: Mechanical drum filter

sport fishing area. The waste water of the three filters (backwash water) is passed through three thickening cones (around half a cubic meter each) (Figures 5 and 6).



Figure 5 and 6: Thickening tanks

A final silo (Figure 7) collects the concentrated effluents of the three thickening cones. The sludge is released from the silo to a storage tank through an automated valve. This sludge valve is opened automatically for 10 seconds every 10 minutes: if the supernatant becomes dark a colour-detector cell (Figure 8) operates the sludge valve for 25 seconds every 6 minutes. After eight such activations, if the supernatant is still dark, the sludge valve is opened again, for 2 minutes and 30 seconds, to partially empty the silo.



Figure 7: Final silo



Figure 8: Supernatant colour detector system

Effluent characterisation

Filter effluents

The average SS concentration of the rearing water is about 4 mg/l. Each drum filter has a capacity of 600 l/s. After filtration, the average SS concentration of the filtered water is around 2-3 mg/l, and the backwash water (around 1 l/s) is around 1 g/l. Table 2 presents the concentration of dissolved substances in the backwash waters.

Table 2: Concentrations of significant dissolved substances in the backwash water from the three mechanical filters installed at Murgat Farm.

	Backwash water - pre-growing unit			Backwash water - on-growing unit, sector 1			Backwash water - on-growing unit, sector 2		
	Concentration (mg/l)			Concentration (mg/l)			Concentration (mg/l)		
	mean	min	max	mean	min	max	mean	min	max
NO3-N	5.0±2.0	1.8	6.9	6.9±0.9	4.6	7.5	5.6±1.9	1.6	6.8
TAN[1]	3.4±3.4	0.5	8.6	0.3±0.1	0.2	0.6	1.5±1.6	0.4	5.4
PO4-P	2.3±2.6	0.4	8.7	0.3±0.1	0.1	0.5	0.8±0.7	0.2	2.4
NO2-N	0.6±0.6	0.2	1.6	0.4±0.1	0.2	0.6	0.5±0.3	0.1	0.8
Urea-N	0.2±0.1	0.1	0.5	0.1±0.0	0.1	0.2	0.2±0.1	0.1	0.5

Thickening cone treatment

The backwash waters coming from the three filters are collected in three thickening cones. After this primary concentration, the mean SS concentration of the effluent from the thickening cone is around 1-5 g/l (with an mean flow rate of 0.4 l/s). Table 3 shows the concentration of dissolved substances in the concentrated effluents and in the supernatants of the three thickening cones.

Concentrated effluent from the final thickening system (silo)

A final thickening silo receives the concentrated effluent from the three thickening cones. This secondary concentration treatment generates supernatant and a concentrated sludge.

Table 3: Mean concentrations of dissolved substances in the supernatant and the concentrated effluent of the thickening cones.

	Supernatant (mg/l)	Concentrated Effluent (mg/l)
	Pre-growing unit	
NO ₃ -N	6.6±0.6	2.4±2.4
TAN	0.8±0.7	6.6±6.2
PO ₄ -P	0.9±0.7	5.7±3.9
NO ₂ -N	0.2±0.2	0.5±0.5
Urea-N	0.1±0.0	0.3±0.2
	On-growing unit, sector 1	
NO ₃ -N	7.4±0.5	3.1±3.1
TAN	0.3±0.2	2.9±2.4
PO ₄ -P	0.4±0.3	4.4±4.7
NO ₂ -N	0.2±0.2	0.6±0.6
Urea-N	0.1±0.1	0.3±0.1
	On-growing unit, sector 2	
NO ₃ -N	7.4±0.8	1.9±2.5
TAN	0.3±0.3	10.0±8.5
PO ₄ -P	0.6±0.5	7.6±6.9
NO ₂ -N	0.3±0.4	0.5±0.5
Urea-N	0.1±0.1	0.3±0.1

4. Management of the final effluents

Management of the silo supernatant

The flow rate of the supernatant from the silo averages 15 m³/day. Suspended solids concentration fluctuates between 90 and 500 mg/l. The mean concentrations (±SD) of TAN and PO₄-P are respectively 9.2 ± 8.1 mg/l and 8.4 ± 6.3 mg/l. The high nutrient concentrations and low flow rate of the supernatant are favourable characteristics for an efficient treatment of effluent before release into the river. Constructed wetlands are appropriate systems to treat this type of effluent.

Three wetlands were constructed in an existing unused raceway divided into three equal sections (each 25 m x 6 m x 0.8-1 m deep) (Figures 9 and 10). Each wetland was filled with a layer of stones (5-15 cm diameter), geotextile, and a layer of sand approximately 10 cm thick). *Typha latifolia* (common bulrush) plants were planted in March 2006.



Figure 9 and 10: Constructed wetland systems (Fig 9. After planting, Fig 10. Current wetlands)



Figure 11 and 12: Horizontal wetland system and vertical wetland systems

The supernatant from the final silo is treated in two types of constructed wetland:

- horizontal wetland where the effluent passes horizontally through gabions and through the entire substrate (Figure 11)
- vertical wetland where the effluent is distributed by pipes and passes vertically down to the bottom of the wetland (Figure 12).

The third wetland treats the supernatant from the sludge storage tank and the effluent from the vertical wetland.

Results

Physical, chemical and biological processes are combined in wetlands to purify the effluent.

- *Suspended solids treatment*

A proportion of the suspended solids remaining in the final effluents and supernatant are physically filtered out by the wetland media (sand and

gravels): (1) the SS within the supernatant from the final silo are reduced by 89.7% in the horizontal and vertical wetlands; (2) the SS of the supernatant from the sludge settling tank and the effluent from the vertical wetland are reduced by 72.7% in the horizontal wetland. Values for selected physico-chemical parameters of the wetlands are presented in Table 4.

All the wetland systems present anaerobic conditions, with oxygen concentrations lower than 1 mg/l, which is confirmed by negative redox values at their outlets.

- *Nitrogen transformation*

In aerobic conditions, ammonia ($\text{NH}_{3(\text{aq})}$) is oxidised into nitrites (NO_2^-) and nitrates (NO_3^-) through nitrification (*Nitrosomonas* bacteria oxidise ammonia to nitrite and *Nitrobacter* bacteria oxidise nitrite to nitrate). Both nitrate and nitrite are reduced in the wetlands, as suggested by very low outlet concentrations (see Table 4). As the experimental wetlands present anaerobic conditions, we can suppose that denitrification processes occur in the systems, following the general sequence shown⁴, with nitrous oxide (N_2O) and nitrogen (N_2) gases as end products:

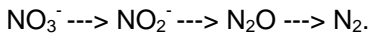

Table 4: Physico-chemical parameters of the three constructed wetlands, June 2006 - January 2007. Average values of 8 monthly samples.

Wetland type	Effluent treated		Silo supernatant		Sludge storage tank supernatant and Vertical Wetland Effluent	
	Horizontal		Vertical		Horizontal ('Wetland 3')	
	Inlet	Outlet	Inlet	Outlet	Inlet	Outlet
pH	6.8	7	6.8	6.9	6.8	6.9
Redox (mV)	42	-64	42	-62	-38	-65
O ₂ (mg/l)	1.3	0.4	1.3	0.43	0.6	0.6
T °C (summer)	36	17.4	36	17	20.2	17.6
T °C (autumn)	15.7	15.5	15.7	15.9	15.9	16.3
T °C (winter)	7.8	7.6	7.8	7.3	7.1	9.5
PO ₄ -P (mg/l)	3.2	7.5	3.2	5.2	11.2	9.5
NO ₂ -N (mg/l)	0.4	0	0.4	0	0.1	0
NO ₃ -N (mg/l)	1.3	0	1.3	0.1	0.3	0
TAN (mg/l)	12.1	50.3	12.1	54	66.9	44.9
Suspended solids (mg/l)	784	104	784	57	422	115

Denitrification is considered⁵ as the predominant microbial process modifying the balance of nitrogenous components in a wetland.

In most of the Murgat samples, the TAN concentrations are higher at the outlet of the wetlands treating the supernatant of the silo than at the inlet (Table 4). This is probably due to an important organic nitrogen mineralization. It has been shown⁶ that NH_4^+ can be immobilised onto negatively charged soil particles. Under anaerobic conditions the immobilised NH_4^+ can be stable and predominates⁷. In such wetlands, part of the effluent ammonia is probably stored in this stable form.

In the third wetland (treating the sludge supernatant and the vertical wetland effluent), ammonia outlet concentrations were lower than the inlet concentrations; in this system the transformation of the ammonia into N_2 through an anammox process (Figure 13) could explain the difference.

- *Phosphorus transformation*

Organic phosphorus contained in the silo supernatant is mineralised in its $\text{PO}_4\text{-P}$ form by micro-organisms in the wetlands (horizontal and vertical), as $\text{PO}_4\text{-P}$ increases at the outlet. The third wetland, treating the supernatant of the sludge storage tank and the effluent from the vertical flow wetland, presents a lower $\text{PO}_4\text{-P}$ concentration at the outlet. This could be explained by a $\text{PO}_4\text{-P}$ fixation on the media similar in nature to that suggested above for $\text{NH}_4\text{-N}$.

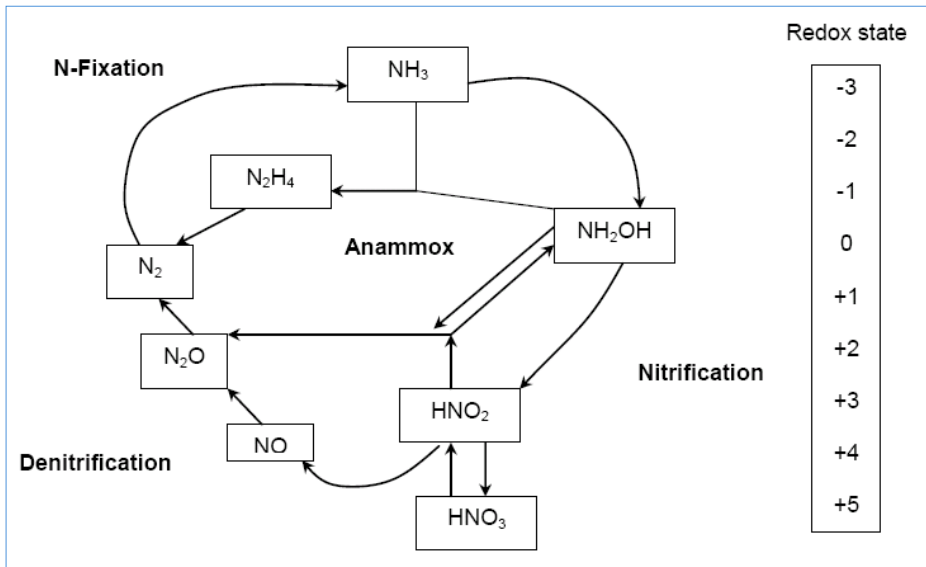

Figure 13: Nitrogen cycle showing the educts, intermediates and products of the important processes of N-fixation, nitrification, denitrification and anammox⁸

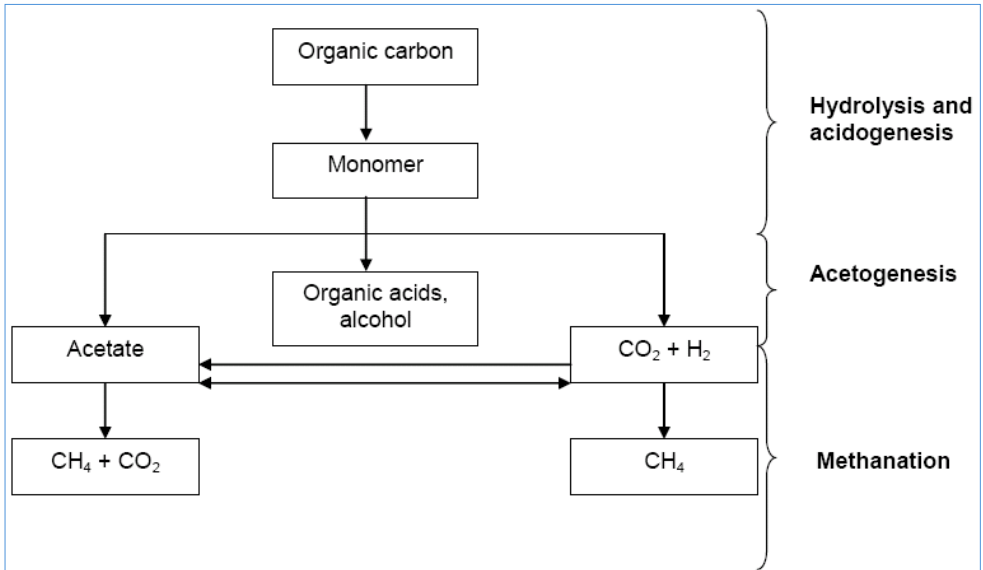

Figure 14: Methanogenesis pathways



Figure 15: Current sludge storage system: settling tank with wood shavings

- *Effect on the water quality in the river*

The three wetland outlets are released into the sport fishing area. At this point, the concentrations of the main pollutants are very low: 9 mg/l for suspended solids, 0.7 mg/l for NH₄-N and 0.03 mg/l for NO₂-N.

Future experiments

Further experiments are necessary to understand and model the functioning of the bacterial component in greater detail: bacteria characterisation (autotrophic, heterotrophic and sulphur bacteria, for example), and gas production. Nitrogen gas production through the de-nitrification process and carbon gas production through the methanation process (Figure 14) are likely to be important and will be studied.

Management of the final sludge

The sludge flow rate from the silo is around 3 m³/day and the solids content of the sludge at the outlet of the silo averages only 60-80 kg/m³. For handling purposes and to add value, the sludge has to be concentrated to 200 kg/m³. The sludge is currently stored in a sludge storage tank (Figure 15) and covered with wood shavings (spread daily), which avoids bad odours and increases the solids content of the sludge up to 140 kg/m³ after a few months of storage.

The sludge has a good agronomic value, as shown in Table 5.

Table 5: Sludge composition at Murgat Farm

		sludge (silo outlet)	sludge after 5 months of storage	sludge after 9 months of storage
pH		5.9	6.6	-
Suspended Solids	kg/m ³	60	117	129
Organic Matter	% dw	74.3	62.3	-
Mineral Matter	% dw	25.7	37.7	-
Total Organic Carbon	g/kg dw	412	467	-
Total N (Kjeldahl)	g/kg dw	32.3	38.6	35.8
Total P (P ₂ O ₅)	g/kg dw	20.6	92.1	89
Potassium (K)	g/kg dw	1.5	1.2	1.3
K ₂ O	g/kg dw	-	< 2.0	1.5
NH ₄ -N	g/kg dw	5.3	6.5	-
Calcium (CaO)	g/kg dw	87	147.6	159.9
Magnesium (Mg)	g/kg dw	1.2	1.1	1.1
Zinc (Zn)	g/T dw	601	-	534
Copper (Cu)	g/T dw	17.8	-	28.6

Table 6 presents the heavy metal concentrations; all are below the EU legal threshold.

Table 6: Heavy metals content of sludge at Murgat Farm; PAH = Polyaromatic hydrocarbons

Parameter	Unit	Value
Cadmium (Cd)	g/T dw	1.2
Total chromium (Cr)	g/T dw	15.6
Nickel (Ni)	g/T dw	4.3
Lead (Pb)	g/T dw	<8.2
Mercury (Hg)	g/T dw	<0.1
Selenium (Se)	g/T dw	<1.2
Cr+Cu+Ni+Zn	g/T dw	582.7
PAH benzo(a)pyrene	mg/kg	<0.8
PAH benzo(b)fluoranthene	mg/kg	<1.4
PAH fluoranthene	mg/kg	<1

The Polychlorinated biphenyls (PCB 28,52,101,118,138,153,180) are below the EU legal threshold.

The current way of sludge valorisation is a land application, twice a year.

Summary of the whole treatment system

This treatment system reduces by 50% the suspended solids that would otherwise be released to the ecosystem (river). For an average annual farm production of 91 tonnes of solids, around 47 tonnes are collected by the treatment system shown (Figure 3).

5. Physical and chemical treatment processes and valorisation limits

Sludge concentration

Different bacteria, coagulants and flocculants were tested in order to improve the settling process.

Bacterial treatment

An activated bacterial concentrate was injected for two months into the final silo. The considered by the farmer to be too high at the farm scale (€15,000 per year). bacterial treatment was difficult to apply, because of the necessity of warming up the product before injection at a very low flow rate.

The results were unconvincing; there was no improvement of the particle sedimentation in the silo. Even worse, the SS content of the sludge decreased

and the SS content in the supernatant increased. This could be explained by a bacterial activity involving mineralization of the particulate matter in the silo, which was shown by an increase of TAN and PO₄-P concentrations in the supernatant, as shown in Figure 16.

Coagulant-flocculant treatment

Coagulants and flocculants selected through an earlier project (CRAFT project n° FAIR CT98-9110 coordinated by STM aquatrade S.r.l.) were tested on a small scale. The cost of these treatments was.

Geotextile tube

It was intended to test a sludge dewatering system using a geotextile tube, which is claimed to allow dewatering of the suspended solids. However, the local solution of sludge dewatering and storage in a settling tank covered with wood shavings (which increased the SS content up to 14 kg/m³), before draining (through a liquid manure pump) and subsequent transport away as a fertilizer, was considered to be satisfactory.

Sludge treatment

Some experiments were planned to test a constructed wetland as a sludge treatment system. However, the plants (common bulrush, *Typha latifolia*) were burned after few weeks, probably because of the acidity of the sludge. Other wetland species, such as common reeds (*Phragmites australis*), may

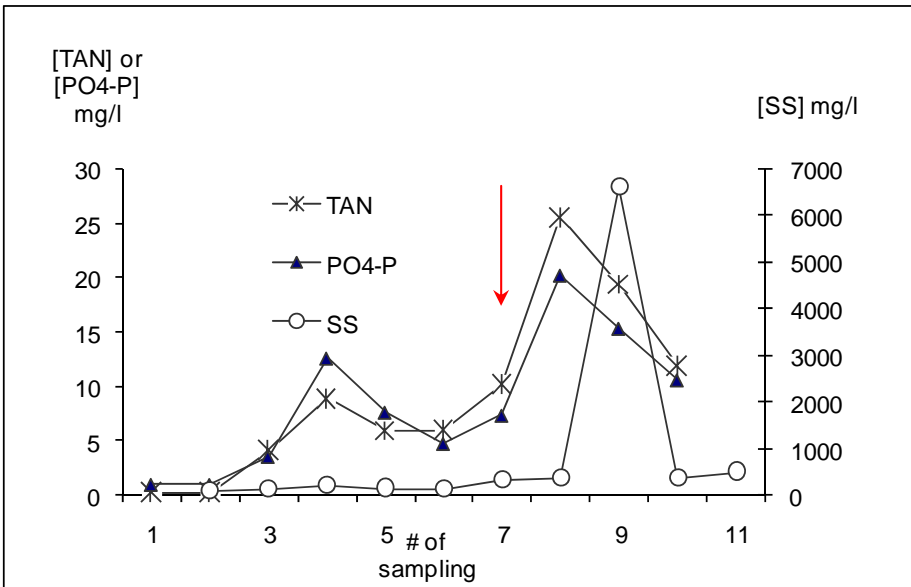

Figure 16: Suspended Solids, Total Ammonia Nitrate and Phosphorous (PO₄-P) concentrations in the silo supernatant before and after bacteria injection (red arrow)

have been more resistant to the sludge acidity but were not tested, because the sludge problem was solved.

Sludge valorisation

There are two main difficulties for sludge valorisation, which are related to the costs of transport and treatment. It was decided to work on possible sludge valorisation through land application and composting. A local private enterprise asked for around €50/tonne of sludge to treat the sludge as a compost. This was considered too expensive at the farm level, representing around €25,000 per year, or €0.041/kg of fish produced, before adding the cost of transport.

6. Recipient ecosystem quality: water and biology

The concentrations at the river control point are below the maximum authorized concentrations, as shown in Table 7.

The water quality at the river control point was very high before 2004, and there

Table 7: Average concentrations at the river control point (2004 - 2005) in comparison with the maximum authorized concentrations for the farm discharge (fixed by prefectural order).

	2004 Average (mg/l)	2005 Average (mg/l)	2006 Average (mg/l)	Maximum Authorised (mg/l)
NH ₄ -N	0.59	0.50	0.55	1
SS	2.62	2.45	2.10	5
BOD ₅	< 3	5	< 3	10

has been a further decrease in the average SS content since the treatment system has been in operation.

The recipient-water biological quality was evaluated using the French standard known as the IBGN (standardised global biological index), as it applies to French water law. This index is based on a study of the insects, crustaceans, molluscs and worms living in the superficial layer of the sediment at the site concerned.

This evaluation established the diversity in the river of the 138 determinant macro-invertebrate species listed in the Standard Protocol and the presence/absence of pollution-sensitive indicators, of the 38 listed. Those two data gave the IBGN score, equivalent to a specified biological water quality (Table 8, see next page).

In 1985-1986, the recipient ecosystem below the Murgat farm showed a 'Fair' biological quality, with an IBGN score of 11/20. One year after the whole effluent treatment system installation (in April 2007), another IBGN study was done downstream the farm outlet. According to the IBGN score obtained (14/20), the recipient ecosystem showed a better biological quality, corresponding to a 'Good'

Table 8: IBGN scores and their associated water quality colour categories

IBGN mark	>16	15-13	12-8	8-5	<5
Colour category	Blue	Green	Yellow	Orange	Red
Corresponding water quality	Excellent	Good	Fair	Poor	Very poor

river quality category. The Murgat effluent treatment system had a positive effect on the recipient ecosystem biological quality, and nowadays there are more rare and pollution-sensitive species in the recipient river. The IBGN studies are described elsewhere in this manual.

7. Future prospects for improvement

Currently, as described, the rearing water is passed through mechanical filters: particles are trapped on the mesh and discharged in the backwash water. The filtered water is reused in other tanks, before release to the river after the final mechanical filter. This filtered water contains less solids than if left untreated, but still contains high concentrations of dissolved components, such as TAN. The removal of TAN from wastewater is important because of its toxicity to organisms and ecosystems.

French legislation sets maximum authorised concentrations at the river control point for three parameters: SS, BOD₅ and NH₄-N. One way to improve the effluent treatment system would be to treat the dissolved nutrients in the filtered water. The literature shows that wetlands could provide an efficient ammonia treatment and reduce it to acceptable levels through nitrification. The minimum residence time necessary for successful nitrification in a biological filter is around four minutes. If we consider the nitrification process to be as efficient in the wetland as in a biofilter, a planted raceway (6 m x 75 m x 0.8 m deep) will be sufficient to reduce part of the ammonia in the filtered water of the farm. A difficulty in the case of the Murgat farm would be to divert the farm outlet flow (600 - 2000 l/s) from the farm outlet point to the wetland system. A pump or a gravity system would be necessary, potentially generating additional costs.

8. References

1. Jatteau P. (1999). Quantification des flux polluants. Effluent wastes assessment. INRA, Paris. In: Environnement et aquaculture: t1 Aspects techniques et économiques, PETIT J. pp 74-87.
2. Submitted to 'Aquaculture' journal: Roque d'orbcastel E., Blancheton J.P., Boujard T., Aubin J., Moutounet Y., Przybyła C. and Belaud A. (2006). Comparison of two methods for evaluating waste of a flow-through trout farm.
3. Wetzel R.G. (1983). Limnology. Saunders College publishing. Orlando, Florida. pp 255-297.

4. Richardson C.J., Tilton D.L., Kadlec J.A., Chamie J.P.M. and W.A. Wentz. (1978). Nutrient dynamics of northern wetland ecosystems. In: *Freshwater Wetlands: Ecological Processes and Management Potential*. Good R.E., Whigham D.F. and Simpson R.L. (Eds.), Academic Press, New York, pp 217-241.
5. Mitsch, J.W. and J.G. Gosselink (1986). *Wetlands*. Van Nostrand Reinhold Company, New York. 536 pp.
6. Brock, T.D. and M.T. Madigan (1991). The bacteria. Chapter 19 in *The Biology of Microorganisms* (6th edn.). Prentice-Hall Inc., Englewood Cliffs, NJ, USA, pp 703–716.
7. Patrick, W.H. Jr. and K.R. Reddy (1976). Nitrification-denitrification in flooded soils and water bottoms: dependence on oxygen supply and ammonium diffusion. *Journal of Environmental Quality*, 5:469-472.
8. From Egli, K.R. (2003). On the use of anammox in treating ammonium-rich wastewater Ph.D. Thesis, Swiss Federal Institute Of Technology, Zurich. In Michaud L., 2007. thesis

9. IBGN study: Murgat

E. Roque d'orbcastel, L. Ceruti and J.P. Blancheton

This study used the Standardized Global Biological Index (IBGN) to assess the benefit of the aquaculture effluent treatment system at Murgat farm, France, on the quality of the recipient river. The aim of this index, determined by the study of benthic macro-invertebrates, is to assess the biological quality of a watercourse against a standardized general typology. The method (French National Standard NF T 90-350) records changes in the biological quality of a watercourse over a period of time. Tables used to determine the SGBI are provided at Annex 1 and 2.

project: in July 2006 and in April 2007. The results were compared with the same type of assessment carried out at Murgat in 1985-1986, when the farm was releasing effluent without treatment. The same protocol was used for both studies (1985-86 and 2006-07).

1. Materials and methods

The assessment was made twice at Murgat during the AquaETreat Determination of the IBGN for a watercourse uses 138 taxa (Annex 2) with the family as the taxonomic unit, or sometimes the branch or the class. Thirty-eight (38) of the 138 determinant taxa are bio-indicators. They are assigned different colours according to their sensitivity to pollution (see Annex 2).

Each sampling site has to be 10 times greater in length than in width. Eight samples, representing the natural diversity of the site, are needed for the determination of each IBGN. Each sample is characterized by a substrate category (10 substrates, designated 0 - 9) and a water flow rate (5 levels). If the site does not present eight different substrates, several samples are made for one substrate at different spots characterized by different water velocities. The area covered by the sampling site, and the water level, are recorded in a sampling table (Annex 1). Cells in the table are completed for each substrate/flow rate pair.

2. Protocol

A "Surber" sampler (Figure 1) is placed on the substrate with the net facing into the water flow direction. The sampler characteristics are standardized, with a surface area of $1/20 \text{ m}^2$ and a mesh size of 0.5 mm.

After sorting, the macro-invertebrate samples are preserved in a 10% formalin solution. Identifications are made using a key to determine the branch, the class, the order and the family of each macro-invertebrate in each sample.



Figure 1: IBGN Surber sampler

3. Determining the Index (IBGN)

The total number of different taxa recorded for the sampling area is calculated and tables are used to determine the Taxonomic Variety (TV) (from 1 – 14). The Taxonomic Variety gives information about the substrate quality: the higher the Taxonomic Variety, the better is the biogenic quality.

The faunal indicator group number (IG) (from 1 to 9) is also required to determine the Index. It gives information on the water quality of a sample and is obtained by reference to the Table shown at the end of Annex 2.

Finally, the IBGN (from 0 – 20) is read from a Table (Annex 3) at the point of intersection between the TV column and the IG row. The maximum IBGN is 20. Each IBGN can be interpreted according to a standard colour category (Table 1).

Table 1: IBGN and corresponding colour categories

IBGN	>16	15-13	12-8	8-5	<5
Class	Blue	Green	Yellow	Orange	Red
Quality	Excellent	Good	Fair	Poor	Very poor

4. Conditions and limits

The IBGN is not appropriate for estuaries, wells and large watercourses (water depth has to be less than 1 m). This may be considered as a problem, at least a limitation in our case, since the water used by the farm originates from a spring from which the water flow is partly pumped.

The flow rate of the watercourse must have been stable for 10 days. To allow meaningful samples, the water flow rate should not be too high and water turbidity must be low.

The Index can change according to the season, as a consequence of biological cycles and changes in environmental conditions.

5. Murgat farm effluent monitoring : the recipient ecosystem quality

The Murgat farm uses two water springs, the Oron well water and the water from the “bief Lacour” (figure 2).

Farm effluent is discharged into the Oron, and then into a channel: “Canal de la Raille”.

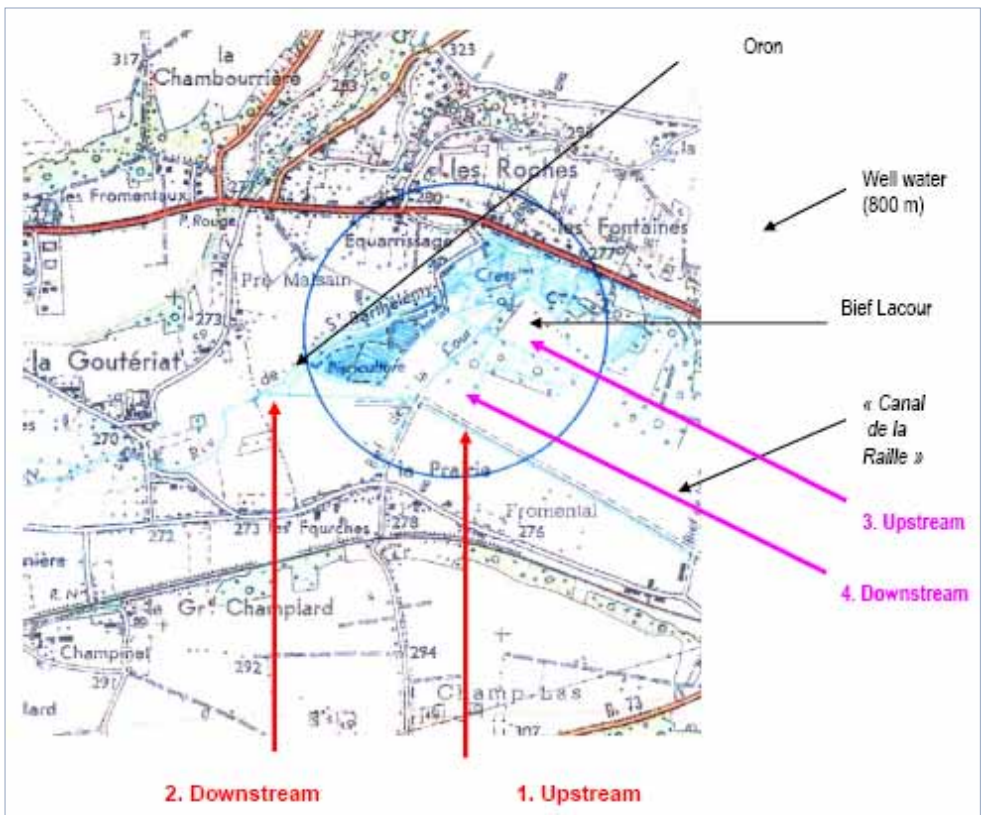

Figure 2: Murgat farm situation and IBGN sampling points

The “reserved flow rate” (water flow that the farmer has to release into the river without using it in the farm) is also released in the “Bief Lacour” when the watercourse level is low.

6. Results

July 2006

In July 2006, two IBGN were assessed upstream and two downstream of the place where the farm effluent discharges:

1) in the Oron and the Canal de la Raille :

upstream IBGN : **10/20** with IG= 5 and TV= 6.

downstream IBGN : **11/20** with IG= 5 and TV= 7.

Both indicate a fair water quality. This low Index can be explained by the water origin (well water) which is biologically poor; furthermore, the samples were taken in summer when most insects are in their flying phase and others are in their larval phase, making determination difficult. At this area, the 1985-86 study showed an Index of **12/20** upstream and **11/20** downstream.

2) in the “Bief-Lacour”:

upstream IBGN : **11/20** with IG= 7 and TV= 5.

downstream IBGN : **8/20** with IG= 3 and TV= 6.

Downstream of the outlet of the farm, the water quality falls within the poor category and the biological diversity decreases.

April 2007

In April 2007, two Indices were determined upstream and downstream of the main discharge point of the farm (in the Oron and the Canal de la Raille). There was no discharge into the “Bief Lacour” at this period.

upstream IBGN n°1: **15/20** with IG= 7 and TV= 9.

downstream IBGN n°1 : **14/20** with IG= 7 and TV= 8.

upstream IBGN n°2 : **15/20** with IG= 8 and TV= 8.

downstream IBGN n°2 : **14/20** with IG= 6 and TV= 7.

The water quality and the substrate quality of habitats are ‘Good’ downstream the outlet of the farm, with a biological quality than upstream (fewer insects and more detritus-consuming animals).

7. Conclusion

Since the whole effluent treatment system was set up in 2006, the biological quality of the recipient ecosystem has improved, with a current 'good' biological quality.

The effluent treatment system had a positive impact on biological communities with more rare and pollution-sensitive species found in the 2007 samples. In spite of the short duration of the AquaETreat project, the treatment of effluent at Murgat farm had a measurable and positive effect on the recipient ecosystem.

Annex 1: The role of algal photosynthesis in transforming fish farm wastes into usable resources

Name of the stream :					
Name of the sampling site :				Date :	
Hydrology : • Low water • Average waters • Others					
Water temperature (°C)	Turbidity (cm) (Secchi)	pH	Conductivity (µS)		
Surface water speed V (cm/s)	V>150	150-75	75-25	25-5	V<5
Supporting habitat:					
Bryophytes	9				
Submerged seed-plants	8				
Coarse organic elements (litter, twigs, roots)	7				
Large mineral sediments (stones, pebbles) (>25 mm)	6				
Coarse aggregates (25 mm – 2.5 mm)	5				
Emergent marginal seed-plants	4				
Organic fine sediments, "mud" (<0.1 mm)	3				
Sand and silt grains (<2.5 mm)	2				
Natural and artificial areas (rocks, slabs, soil, walls) (blocks >250 mm)	1				
Algae or bare marl and clay	0				

Example of completed cell:

4	(3)	25 cm
---	-----	-------

4 = sample number (from 1 - 8)

(3) = cover abundance of the sampled substrate:

(1) incidental (2) scarce (<10%) (3) abundant (10 - 50%) (4) very abundant

25 cm = water depth at the sampling location.

Annex 2 : List of the 138 taxa used for the IBGN, List of fauna

<p>INSECTS</p> <p>PLECOPTERA Capniidae(8) Chloroperlidae(9) Leuctridae(7) Nemouridae(6) Perlidae(9) Perlodidae(9) Taeniopterygidae(9)</p> <p>TRICHOPTERA Beraeidae(7) Brachycentridae(8) Ecnomidae Glossosomatidae(7) Goeridae(7) Helicopsychidae Hydropsychidae(3) Hydroptilidae(5) Lepidostomatidae(6) Leptoceridae(4) Limnephilidae(3) Molannidae Ondotoceridae(8) Philopotamidae(8) Phryganeidae Polycentropodidae(4) Psychomyidae(4) Rhyacophilidae(4) Sericostomatidae(6) Thremmatidae</p> <p>EPHEMEROPTERA Baetidae(2) Caenidae(2) Ephemerellidae(3) Ephemeridae(6) Heptageniidae(5) Leptophlebiidae(7) Oligoneuriidae Polymitarcidae(5) Potamanthidae(5)</p>	<p>Prosopistomatidae Siphonuridae</p> <p>HETEROPTERA Aphelocheiridae(3) Corixidae Gerridae Hebridae Hydrometridae Naucoridae Nepidae Notonectidae Mesoveliidae Pleidae Veliidae</p> <p>COLEOPTERA Curculionidae Donaciidae Dryopidae Dystiscidae Eubriidae Elmidae(2) Gyrinidae Haliplidae Helodidae Helophoridae Hydraenidae Hydrochidae Hydrophilidae Hydrosaphidae Hygrobiidae Limnebiidae Spercheidae</p> <p>DIPTERA Anthomyzidae Athericidae Blepharoceridae Ceratopogonidae Chaoboridae Chironomidae(1) Culicidae</p>	<p>Dixidae Dolichopodidae Empididae Ephydriidae Limoniidae Psychodidae Ptychopteridae Rhagionidae Scatophagidae Sciomyzidae Simuliidae Stratiomyidae Syrphidae Tabanidae Thaumaleidae Tipulidae</p> <p>ODONATA Aeschnidae Calopterygidae Coenagrionidae Cordulegasteridae Corduliidae Gomphidae Lestidae Libellulidae Platycnemididae</p> <p>MEGALOPTERA Sialidae</p> <p>PLANIPENNIA Osmylidae Sysyridae</p> <p>HYMENOPTERA</p> <p>LEPIDOPTERA Pyrilidae</p> <p>SHELLFISH</p> <p>BRANCHIOPODA</p> <p>AMPHIPODA Gammaridae(2)</p> <p>ISOPODA Asellidae(1)</p>	<p>DECAPODS Astacidae Atyidae Grapsidae Cambaridae</p> <p>MOLLUSCS(2)</p> <p>BIVALVIA Corbiculidae Dreissenidae Sphaeriidae Unionidae</p> <p>GASTROPODS Ancylidae Bithynidae Bythinellidae Hydrobiidae Lymnaeidae Neritidae Physidae Planorbidae Valvatidae Viviparidae</p> <p>WORMS</p> <p>ACHAETA(1) Erpobdellidae Glossiphonidae Hirudinidae Piscicolidae</p> <p>TRICLADIDA Dendrocoelidae Dugesidae Planariidae</p> <p>OLIGOCHAETA(1)</p> <p>NEMATHELMINTHES</p> <p>HYDRACARI</p> <p>HYDROZOA</p> <p>PORIFERA</p> <p>BRYOZOA</p> <p>NEMERTEA</p>
--	---	--	--

green	blue	cyan	violet	mauve	pink	orange	grey	red
IG9	IG8	IG7	IG6	IG5	IG4	IG3	IG2	IG1

Annex 3:

Variety class (TV)		14	13	12	11	10	9	8	7	6	5	4	3	2	1
Indicators taxa	St	>	49	44	40	36	32	28	24	20	16	12	9	6	3
	IG	50	45	41	37	33	29	25	21	17	13	10	7	4	1
Chloroperlidae															
Perlidae	9	20	20	20	19	18	17	16	15	14	13	12	11	10	9
Perlodidae															
Taeniopterygidae															
Capniidae															
Brachycentridae	8	20	20	19	18	17	16	15	14	13	12	11	10	9	8
Odontoceridae															
Philopotamidae															
Leuctridae															
Glossomatidae	7	20	19	18	17	16	15	14	13	12	11	10	9	8	7
Beraeidae															
Goeridae															
Leptophlébiidae															
Nemouridae															
Lepidostomatidae	6	19	18	17	16	15	14	13	12	10	9	8	7	6	5
Sericostomatidae															
Ephemeridae															
Hydroptilidae															
Heptageniidae	5	18	17	16	15	14	13	12	11	10	9	8	7	6	5
Polymitarcidae															
Potamanthidae															
Leptoceridae															
Polycentropodidae	4	17	16	15	14	13	12	11	10	9	8	7	6	5	4
Psychomyidae															
Rhyacophilidae															
Limnephilidae (1)															
Ephemerellidae (1)	3	16	15	14	13	12	11	10	9	8	7	6	5	4	3
Hydropsychidae															
Aphelocheiridae															
Baetidae (1)															
Caenidae(1)	2	15	14	13	12	11	10	9	8	7	6	5	4	3	2
Elmidae (1)															
Gammaridae (1)															
Molluscs															
Chironomidae (1)															
Asellidae (1)	1	14	13	12	11	10	9	8	7	6	5	4	3	2	1
Achets															
Oligochets (1)															

(1) Taxa represented by at least 10 individuals. Others by at least 3 individuals

10. Sludge: Valuable resource or disposal problem

D. Chadwick, G. Donaldson, J. Laws and V. Zonno

1. Introduction

Sludge comprises uneaten fish pellets, faecal material, soluble metabolite products¹ and also any particles that enter the tanks/raceways with the water inflow. Fish sludge may be described as the 'solids' part of the waste stream in a fish farm. The water content of sludge depends on the system used to separate the solid and liquid fractions.

Farmed fish are fed pelleted feed to provide a balanced diet for optimum growth rates. Feeds contain nutrients such as nitrogen (N) and phosphorus (P) as well as trace elements. Since fish typically utilise only 30% of the ingested N and P, the remainder is voided. Most of the voided N is dissolved and lost through the gills, whereas for P, the majority is associated with the solid material and is excreted in the faeces².

Fish farm effluents containing P and N have been reported to have caused eutrophication of receiving waters^{3,4}. Sludge can be removed from effluent water by mechanical filters or by settlement, with or without the use of flocculating agents. Sludge is removed to comply with legislation governing the quality of water discharged to the water catchment. It may also be removed from recycled water to maintain healthy conditions for fish growth.



Picture 1: slurry application via the 'splash-plate' technology (photo D. Chadwick)

Under certain environmental conditions, P and N can be released from nutrient-rich sludges⁵ and may stimulate algal growth⁶.

Fish sludge contains nutrients and organic matter which have potential for spreading on agricultural land to reduce the amount of inorganic fertiliser required. Furthermore, such reuse of nutrients may offer a low cost 'disposal' option.

However, fish sludge can contain harmful substances, such as heavy metals and pathogens which would limit its suitability for use as fertiliser. Sludge from saltwater fish farms can also contain significant quantities of sodium (Na) which may adversely affect soil structure.

In order to optimise the use of fish sludge on land and to minimise negative environmental impact, it is essential to know the nutrient content and plant availability, as well as the content of any heavy metals, Sodium (Na) and viable pathogens (see later).

2. Physico-chemical characteristics of fish sludge

The chemical composition of fish sludge can be expected to vary due to differences in management practice, species, size of fish, feed, aquatic environment (freshwater or saltwater), water flow dynamics and dewatering efficiency. Due to the different efficiencies of dewatering systems it is best to compare nutrient contents on a dry weight basis.

Nutrient contents

It has been shown⁷ that the nutrient content of Rainbow Trout (*Oncorhynchus mykiss*) sludge was in the range of that measured in different animal manures (Table 1).

Table 1: A comparison of the nutrient content of Rainbow Trout (*Oncorhynchus mykiss*) sludge with different livestock manures.

Dry weight g/kg	Freshwater Fish	Dairy cattle	Poultry	Pig
Nitrogen (N)	0.20 – 0.39	0.01 – 1.01	0.13 – 1.50	0.06 - 1.00
Phosphorus (P)	0.06 – 0.47	<0.01 – 0.25	0.01 – 0.40	0.04 – 0.65
Potassium (K)	<0.01 – 0.02	0.01 – 0.65	0.06 – 0.54	0.05 – 0.63

This would suggest that freshwater fish sludge could be utilised in a similar way to livestock manures. Marine sludge has similar values to freshwater (See Table 2, other page), but may also have high levels of sodium.

Freshwater fish sludge contains relatively small quantities of total N and most of this (ca. 80%) is in its organic form. The majority of the N not utilised by fish is voided in a dissolved form in the water. Fish excrete the majority of their nitrogenous wastes across the gills as ammonia⁸ ($\text{NH}_3(\text{aq})$).

Heavy metal contents

Heavy metal content of fish sludge can pose problems if applied to acidic soils where the availability of the heavy metals could result in plant uptake and transport into sensitive ecosystems.

Studies in Chile⁹ and in Canada¹⁰ found levels of heavy metals to be low in both freshwater and marine sludges. Levels of individual heavy metals will reflect their presence in the feed, the farm water supply and native sediment under cages.

Pathogens

No literature was found regarding the impacts of fish sludge applications on pathogen transfers to agricultural land. The risk of pathogen transmission from aquaculture to humans and domestic livestock remains a possibility via this route.

3. Agronomic use of fish sludge

Experiments

Temperate Climate (Southwest UK, 51°N 2°W)

Experiments were conducted at a range of scales to determine the agronomic value of freshwater (Trout, *Oncorhynchus mykiss*) sludge and marine (Turbot, *Psetta maxima*) sludge generated in land-based farms:

- a. Trout and Turbot sludge applied separately to permanent grassland (predominantly *Lolium perenne*) plots at two rates of application (year 1)
- b. Trout and Turbot sludge applied to separate permanent grassland plots at two rates of application (year 2) (different plots to Experiment 1)
- c. Trout sludge applied to potatoes (*Solanum tuberosum*) in field plots, before and after leaf emergence
- d. Trout and Turbot sludge applied as separate treatments to potatoes (*Solanum tuberosum*) in pots in a glasshouse, before and after leaf emergence
- e. Turbot sludge applied to young short-rotation coppice willow (*Salix spp.*) in field plots at several rates of application, before and after leaf emergence
- f. Turbot sludge applied to sugar beet (*Beta vulgaris*) in pots in a glasshouse

Where possible, a cattle slurry treatment was included for comparison.

To improve the reliability of the interpretation of the results, fish sludge was sourced from the same farms for the duration of the project.

Mediterranean Climate (Southern Italy, 40°N 18°E)

Experiments were carried out on tomatoes (*Lycopersicon esculentum*), peppers (*Capsicum annuum*) and amenity grass (*Lolium perenne*) using partially “thickened” (Sea Bass *Dicentrarchus labrax*) sludge from Maribrin fish farm.

- g. Sea Bass sludge at 2 rates mixed with the soil before planting tomatoes, peppers and grass.

Composition and value of sludges used

Table 2 shows the composition of the sludges used in the experiments, in terms of their significant chemical components. At the time of the experiments, no thickened sludge was available in the UK. Analysis of sludge from different stages of the retrieval and thickening processes from the three fish farms in the project will be discussed later.

Table 2: Chemical components of sludges used in experiments. (Data expressed on a fresh weight basis; i.e. as received and used)

Sludge type	Selected Chemical Components (Mean values)						pH
	Dry Matter	Total N	NH ₄ -N	Total P	Total K	Total Na	
	% ¹	kg/m ³	% ¹	kg/m ³	kg/m ³	kg/m ³	
Trout²	1.3	1.37	58	0.38	0.01	0.09	5.9
(range)	(0.5-2.4)	(0.83-2.1)	(35-78)	(0.14-0.9)	(0-0.02)	(0.07-0.11)	(5.3-6.4)
Turbot³	4.3	0.64	39	0.36	0.33	7.61	7.2
(range)	(3.3-6.1)	(0.4-0.83)	(18-60)	(0.11-0.79)	(0.26-0.38)	(5.94-9.19)	(6.8-7.3)
Sea Bass⁴	14.5	3.3	-	0.07	0.75	8.3	7.2
(range)	(14-15)					(4.5-12)	
Cattle⁵	2.2	0.9	52	0.23	1.82	0.13	7.1
(range)	(0.9-4.5)	(0.29-1.9)	(37-66)	(0.09-0.43)	(0.81-3.67)	(0.11-0.16)	(6.8-7.3)
1. Calculated as weight / volume % 2. <i>Oncorhynchus mykiss</i> 3. <i>Psetta maxima</i> 4. <i>Dicentrarchus labrax</i> 5. <i>Bos taurus cv. Freisian</i>							

Table 3: Agronomic and economic values of sludge in Table 2 applied at 50 m³/hectare (not all of these nutrients will be available to plants within the following growing season).

Sludge	pH	Total N kg/ha	P kg/ha	K kg/ha	Na ¹ kg/ha	Value ² € ha
Trout	5.9	68	19	<1	4	60
Turbot	7.2	32	18	16	380	39
Sea Bass	7.2	165	5	46	415	127
Cattle	7.1	45	11	91	6	65
1. Based on UK prices in 2007: N, P, K, @ 0.67, 0.74 & 0.30 €/kg 2. Na not included in the Value calculations						

Agricultural slurries are normally applied at a maximum application rate of 50 m³/ha on a fresh weight basis (higher rates can lead to temporary waterlogging and run-off, and can result in excess nutrients in the soil which cannot be utilised by the crop). Applications of the sludges listed in Table 2 would supply the crop nutrients shown in Table 3 if applied at the rate of 50-m³/ha on a fresh weight basis.

Values in Table 3 may be compared with the crop nutritional needs shown in Table 4 for crops grown on low fertility soils. For more fertile soils crop fertiliser requirements will be less.

Table 4: UK crop fertiliser requirement¹¹ and estimated cost

Crop	N kg/ha	P kg/ha	K kg/ha	Na kg/ha	Cost ¹ €/ha
Potato	225	230	300		409
Sugar beet	100	75	125	150	159 ²
Silage 1 st cut	150	90	140		208
Tomato	120	250	150		309
Pepper	280	110	280		269

1. Based on UK prices in 2007: N, P, K, @ 0.67, 0.74 & 0.30 €/kg
2. Na not included in the Cost calculation

In the case of inorganic fertilisers 30 - 50% of the N would be applied in the seedbed, the remainder would be applied to the growing crop. It is common practice to apply all the P and K (and Na) during seedbed preparation. For most crops, an application of sludge would be a valued contribution to the crop requirements.

Results from experiments

The following results relate to experiments where sludges were applied at agronomic rates for each crop.

a) Grassland plots

- No problems observed, but as the N in the sludge was mainly (75%) as organic N, grass growth response was slow. This would be particularly evident in dry seasons.

b) Grassland plots

- Due to the slow release of the organic N, the agronomic benefit may not materialise until a second silage cut is made.
- Even applications calculated to supply 220 kgN/ha had no detrimental effect on the grass. (510 m³/ha turbot sludge was applied as a split dose 20 days apart.)
- Sludge with a pH below about 5.5 may inhibit a positive response in crops. Ideally, soil pH should be maintained above pH 6.0 for grassland and pH 6.5 for arable crops.

c) Field potatoes

- The early post-emergence sludge treatment applied at a relatively low rate ($10 \text{ m}^3/\text{ha}$) to the young growth showed no visible signs of damage.
- The later post-emergent treatment also showed no visible signs of damage.
- There was no significant agronomic effect of the Trout sludge on potato yield, but this may have been due to the late planting and dry weather during the growing season, since there was also no significant effect of the inorganic N fertiliser treatment on potato yield.

d) Glasshouse potatoes

- Plant emergence was slowed by the before-emergence application of the Turbot and Trout sludges: after two weeks only 50% of the tubers that received turbot sludge and 75% of the tubers that received Trout sludge had emerged compared with 100% for the cow slurry and untreated tubers. Four weeks after planting, plant height - for the Turbot and Trout treatments was only 61 and 89% of the untreated control (100%), respectively, compared with the height of plants treated with cow slurry (119%).



Picture 2: Potatoes experiment, this potato plant received the Turbot and Trout sludge (photo D. Chadwick)

- Applying the fish sludges after emergence had a devastating effect on the plants, killing off the foliage. There were no problems for plants treated with the cow slurry.
- Turbot sludge treatments gave tuber yields significantly less than the untreated control. Trout sludge treatments gave yields similar to the control and cow slurry treatments. All gave yields greater than the control.

e) Short-rotation coppice willows

- Plants receiving the early treatments, applied before leaf buds opened, showed no visible signs of damage, but Turbot sludge was applied at relatively low rates ($2.5 - 10 \text{ m}^3/\text{ha}$).
- The $40 \text{ m}^3/\text{ha}$ treatment applied later to young leaves (plants 15 cm tall) caused severe scorch and even death of the stool. Yield at the end of the season was significantly lower than the (nil) Control and early treatments.
- Separate applications of both Trout and Turbot sludges in the

following year showed no detrimental effects, even to the young shoots, and by the end of the growing season no discernable differences could be seen in crop growth (>2 m tall) between the results of the two treatments.

f) Sugar Beet

- A full rate of Turbot sludge (50 m³/ha) applied before crop emergence had an adverse effect on establishment: only 50% of the seeds germinated and grew into plants. Those that did grow were retarded and stunted, having two fewer leaves than untreated controls. The half-rate sludge (25 m³/ha) was less damaging (75% establishment).
- The sludge treatments before emergence (50 m³/ha) gave a significantly lower dry matter yield than the untreated control. Treatments after emergence generally gave marginally higher yields than the control.
- Sugar beet appears not to tolerate Turbot sludge applied immediately after planting but later applications to established plants posed no problems. Even repeated doses of 50 m³/ha applied after 2, 4 and 6 weeks after establishment did not adversely affect those plants that survived the application before emergence.

g) Mediterranean crops

- The application of Sea Bass sludge to tomatoes can improve yields. This was not true for peppers or Amenity grass.

Conclusions from experiments

- Fish sludge can have significant agronomic and monetary value in providing major crop nutrients.
- Applications before planting are usually safest. These could be made well before planting and should be well mixed in the soil during seedbed preparation or applied to perennial crops in their dormant state.
- Seedbed preparation applications would also give more time for nutrient release for the crops as the main nutrients, N and P, in sludge are held in organic form.
- Applications after emergence can either be useful or disastrous. Consideration must be given to type of leaf. Sludge will quickly run off waxy leaves (sugar beet) and benefit the crop, whereas it may kill potato plants which have softer, hairy, leaves.

4. Recommendations for using fish sludge on crops

1. Determine if there are any legal issues relating to the use of the fish sludge (see Legislation and Regulation).

Having established that it is legal to apply the fish sludge in the particular circumstances concerned, the following steps are recommended.

2. Determine the soil nutrient content. It may have sufficient N, P and K to support much of the crop growth, in which case less sludge is required.
3. Determine what nutrient input is recommended for the crop to be grown. This will be dependant on the soil nutrient supply. There are guidance texts available for some countries, e.g. the UK¹².
4. Determine the nutrient content of the fish sludge in the state it will be applied to the land (i.e. after dewatering or flocculation and settling). A sample will need to be sent to a commercial laboratory for analysis. There will be some nutrient loss during storage, mainly as gaseous ammonia; agitation or aeration would increase this loss.
5. When livestock manures are used, it is recommended that they supply 50 - 60% of the total crop requirement, using inorganic fertilisers to supply the remainder. This reduces the potential risk of over-applying nutrients. The same guidelines should apply for fish sludges.
6. Apply the fish sludge at the estimated rate using calibrated spreading equipment to ensure uniform application.
7. Apply inorganic fertiliser to supply the remaining nutrients.

Notwithstanding the above guidelines, farmers should take note of any national/regional/local advice about timing and rates of applications¹³, and must comply with EU legislation regarding the application of organic materials and nutrients to land, for example with the European Nitrates Directive¹⁴.

5. Sludge characteristics

Sludge characteristics depend on fish species, age, diet and effectiveness of the thickening treatments (including flocculation, filtering, sedimentation). To demonstrate the effect of sludge thickening, fish sludge from a settling tank at a land-based Turbot farm was analysed.

Samples were taken of the deposited material at the bottom of the settling tank (fish sludge) and of the supernatant water in the tank. The composition of the sludge and of the supernatant can be seen in Table 5, together with a typical pig slurry analysis for comparison. The difference in the chemical characteristics of the dry matter in the sludge and in the supernatant is notable. The BOD₅, total N (Kjeldahl), total P and ammonium-N contents of the thicker sludge are much greater than that of the supernatant: thickening up sludge (dewatering) concentrates the nutrients (and microbial populations).

Table 5: Physico-chemical analyses of the effluent from the settling tank at the Turbot (*Psetta maxima*) fish farm. Nutrients expressed on a dry weight basis.

	Dry Matter (%)	pH	BOD ₅ (mg/l)	Total N (g/kg)	NO ₃ -N (g/kg)	NH ₄ -N (g/kg)	Total P (g/kg)	Total K (g/kg)
Supernatant	4.3	7.2	21	0.09	0.00	0.05	0.02	0.81
Fish Sludge	22.6	6.8	5,615	2.65	0.00	0.45	10.09	0.21
Pig Slurry	6.0	7.0	20,000	8.33	0.00	5.00	2.17	4.17

1. Calculated as weight / volume %

Because of the high P content in the fish sludge in the above example, the value of marine fish sludge as a fertiliser is debatable. The application rate of 100 kgP/ha is an impractical 5 m³/ha and for this reason this Turbot product is likely to be classified as a waste. Under present conditions of escalating world price of phosphorous, its recovery from such sludge must be coming increasingly attractive.

The sodium content of marine sludge may not present a problem, if, during filtration, the sieves are back-washed with freshwater, where it might be expected that most of the sodium would be removed from the resulting sludge. (See Cost Analysis Chapter for example figures.) Many plants do need sodium (Na) for maximum yield; together with K, it is involved in osmotic regulation (see Glossary) within the plant. Some crops such as Beet (*Beta vulgaris*), turnips (*Brassica rapa*) and carrots (*Daucus carota*) will still respond to sodium when potassium levels are adequate. Cereals (*Triticum*, *Hordeum* and *Avena* spp.), some varieties of *Brassica oleracea* (e.g. kale, broccoli, cabbages) and peas (*Pisium sativum*) are only responsive when Potassium is deficient. Sodium is soluble and it therefore leaches easily down through the soil profile; up to 50% of soil sodium may be lost in this way each year.

6. Alternative potential uses for fish sludges

Biofertilisation of ponds and growth of polychaete worms

Potentially, thickened sludge obtained from the system could be reused on-site for biofertilisation of (non-fish) aquaculture ponds, thus permitting a horizontal integration of marine fish-farm production through the cultivation of invertebrate species (worms, mussels, crustaceans) with important economic value. On-site use of sludge would remove or reduce the cost of sludge transportation and disposal.

A range of different approaches for the potential reuse of marine waste in aquaculture has been explored within the AquaETreat consortium:

- a. Quantitative and qualitative microfauna analyses of thickened sludge, to assess whether the observed species are suitable for feeding to other cultured species.
- b. A trial of polychaete worm culture using the marine sludge, to evaluate both the potential for sludge reuse and the possible toxic effect of waste components.

The microfauna analyses, on numerous samples of sludge and water from different sectors of the farm, revealed an abundance of polychaetes (*Capitella capitata* and *Boccardia polybranchia*), and crustaceans. Other minor species included individuals of the Maldanidae, Naereidae and Chironomidae families.

The number of microfaunal individuals identified related to management activity at the farm and was closely linked to tank cleaning operations.

The presence of polychaete and crustacean species shows this sludge to be suitable as a nutritive substrate for the rearing of (post-larval) penaeid shrimp, as already documented in the literature.

The first step in reusing the sludge for pond biofertilisation and aquaculture species production is to ascertain that the sludge is not toxic for the animals being cultivated. An experimental trial, exposing two polychaete species to marine sludge for a 7-day period, demonstrated that for *Boccardia polybranchia* the survival was 100% while for *Naineris laevigata* only 30% of the individuals survived

These results are a preliminary indication that on-farm reuse of sludge for aquaculture purposes has potential to produce high quality live feed. Previous research activity, conducted by the same group, had also excluded any toxic effect of sludge exposure on two other marine species (one bivalve mollusc and one crustacean) by measuring the activity of specific biomarkers in the tissues and organs of the animals.

Fungal growth

As part of the AquaETreat project, the growth of *Schizochytrium limacinum* on waste seawaters collected from sludge-thickening processes has been investigated. This organism produces high levels of unsaturated fatty acids from glycerol- or glucose-supplemented waste waters from the Swansea University pilot marine recirculation system. Sterile effluent seawater from a Turbot fish farm, supplemented with glucose or glycerol, has a potential use as a base for fermentation to remove organics and phosphorus, potentially producing high-value products either for fish feed or for other commercial uses (oils). The organisms contain about 20% oil within the cell. Researchers at Swansea University, Wales, have investigated the growth (yields and kinetics) of this organism in seawater supplemented with yeast extract (to simulate waste water) and glucose. The next stage is to investigate the use of real marine waste waters.

Phosphorus recovery

The high phosphorus composition of the sludge, coupled with a rapidly increasing world value for phosphorous, has prompted investigation into release of phosphate from the sludge. The Swansea University research team has studied the release of phosphate as a function of pH, adjusted with inorganic acid or alkali. This has shown that extremes of pH release the phosphate to a limited extent. The release of phosphate via fermentation has been investigated in the absence and presence of glucose, and with the addition of lactic acid bacteria. The results have shown that phosphate is released only when the pH is in acid fermentation conditions. Because the sludge has high buffering capacity there is little or no pH change when the sludge is fermented alone (anaerobic digestion). The addition of glucose acidifies the sludge and releases substantial quantities of phosphate into solution. With the addition of glucose, 70 - 90% of Total P is released with or without additional lactic acid bacteria starter. This work will progress to improvement of sludge dewatering so that the phosphate solution can be readily drained from the sludge. This would create a less problematic sludge for disposal or reuse. Fermentation in the presence of sugar should also stabilise the waste. The other aspect of acid stabilisation is that the zeta potential (see Glossary) of the sludge will also change (become less negative); dewatering may thus be improved. This remains to be investigated.

Biogas production

There is potential for trout sludge to be used in biogas generation if it can be thickened sufficiently to allow its economic transportation to anaerobic digestion plants. It is unlikely that sufficient organic matter would be generated on an individual farm to have an efficient on-farm system. There is some doubt as to how suitable marine fish sludge would be for biogas generation, since the high sodium level may inhibit generation of methane (CH₄).

High value compost

If sludge can be thickened sufficiently, for example to 25% solids content, perhaps by using geotextile filter bags, then it would be reasonable to expect that the organic matter could be composted, thus stabilising the nutrients and potentially reducing pathogens to safe levels.

7. References

1. Thorpe J.E. and Cho C.Y. (1995). Minimising waste through bioenergetically and behaviourally based feeding strategies. *Waste Science and Technology* **31**, 29-40.
2. Hakanson L., Wrvik A., Makinene T. and Moilleg B. (1988). Basic concepts concerning assessments of environmental effects of marine fish farms. Nordic Council of Ministers, Copenhagen, 103 pp.
3. Laird L.M. and Needham T. (1988). *Salmon and Trout Farming*. Ellis Harwood Ltd., England, 271 pp.
4. Foy R.H. and Rosell H. (1991). Loading of nitrogen and phosphorous, suspended solids and BOD from a Northern Ireland fish farm. *Aquaculture* **96**, 17-30.
5. Kibria G., Nugegoda D., Fairclough R. and Lam P. (1997). The nutrient content and release of nutrients from fish food and faeces. *Hydrobiologica* **357**, 165-171.

6. Pettersen K. (1998). The mobility of phosphorous in fish foods and faecals. *Verh. Int. Ver. Limnol.* **23**, 200-206.
7. Naylor S., Moccia R. and Durrant G. (1999). The chemical composition of settleable solid fish waste (manure) from commercial Rainbow Trout farm in Ontario, Canada. *North American Journal of Aquaculture* **61**, 21-26.
8. McDonald M.D. and Wood C.M. (2002). *Evidence for facilitated diffusion of urea in the gills of freshwater rainbow trout*. In: Wright P. and Mackinlay (eds.). Nitrogen excretion in fish. International congress on the biology of fish. University of British Columbia, Vancouver, Canada. pp. 9-12.
9. Salazar F.J. and Saldana R, (2004). Characterisation of manures from fish cage farming in Chile. Proceedings of Xth RAMIRAN Conference 2004.
10. Naylor S., Moccia R. and Durrant G. (1999). The chemical composition of settleable solid fish waste (manure) from commercial Rainbow trout farm in Ontario, Canada. *North American Journal of Aquaculture* **61**, 21-26.
11. Source: UK Government Department of the Environment, Food and Rural Affairs (DEFRA), 2000; RB209.
12. MAFF (now DEFRA). Fertiliser Recommendations for Agricultural and Horticultural Crops (RB209). 2000. 7th Edition.
13. For example, MAFF (now DEFRA). Code of Good Agricultural Practice for Protection of Water. October 1998, has been developed for conditions in the UK.
14. Council Directive 75/440/EEC.

11. Cost analyses

B. Loix

This chapter sets out the cost of the systems chosen in the three farms to help farmers to estimate costs in the purchase and operation of treatment systems.

1. Maribrin

Effluent treatment system

Mechanical filtration

Defining the dimensions of the microsieve filter to be installed was based on the following data:

- volume of effluent to be treated: 80 – 100 l/s
- concentration of suspended solids (SS): approximately 40 mg/l
- mesh size to be used: 60 microns (μm)

For the purposes of the project, it was decided to treat only part of the total effluent from the farm. Farm effluent flow is 300 l/s. A filter, complete with a holding tank, was selected to allow installation without interfering with the operation of the farm. The drum filter selected has a diameter of 1200 mm, a length of 2105 mm and an overall width of 1500 mm. It is designed to treat 80 l/s, with a maximum of 40 mg/l SS and a mesh size of 60 μm . The backwash of the filter produces a total of 5 m³/day (5,000 l/day) sludge, with suspended solids concentration around 1 g/l.

Further concentration

Sludge is stored in a fibreglass tank prior to the next treatment step which involves coagulation and flocculation. The coagulant, a metal salt such as ferric chloride (FeCl_3), is pumped direct to the storage tank receiving the drum filter backwash water (wet sludge). During coagulation, particles are attracted to each other by positive and negative charges. The flocculent is injected directly into the pipeline delivering the coagulated wet sludge to the next treatment device. The flocculent gathers the coagulated particles together into larger 'flocs'. These are of higher density and settle more easily.

At Maribrin, the best results were obtained using 1 ml of a 13% FeCl_3 solution as coagulant and 2 ml of a 1:100 diluted solution of polyacrylamide-based polymer DREWFLOC 2488, obtained from ASHLAND, for each litre of waste water. In both cases the chemical was diluted with water.

Treated sludge was delivered to a belt filter (see the Solids Removal chapter) for further dewatering, which raised the dry matter concentration to 15 - 20% (150 – 200 g/l). The belt filter at Maribrin produced 30-50 kg/day of sludge, thickened to 25% dry matter.

When using seawater and intending to reuse the sludge, backwashing the filter with fresh or low salinity water is preferable. Backwashing with seawater gave 190 g salt/kg sludge. Using freshwater, only 85 g salt/kg sludge was found. This sludge is suitable for agronomic uses.

Cost of the system

Capital costs (early 2007)

- drum filter in 316 stainless steel with a plastic (GRP) holding tank	19,000.00
- civil engineering, electrical work, pipes, etc	5,000.00
- belt filter with tank in 316 stainless steel with dosing pumps	<u>30,000.00</u>
Total	54,000.00

Annual running costs

- depreciation (12.5%, 8 years)	6,750.00
- maintenance (3% of capital cost)	1,620.00
- personnel	5,100.00
- electric power	800.00
- coagulant and flocculant *	<u>1,550.00</u>
Total	15,820.00

*Coagulant and flocculant costs:

Per litre of waste water treated, the following were used:

- 1 ml coagulant (13% FeCl₃ solution) around 1.5€/kg
- 2 ml diluted flocculant 3.70 – 4.60 €/kg

To treat 5 m³/day of waste water, the annual cost was approximately 1,500€ for coagulant and less than 50€ for flocculant.

Fish Production

The filter treats one third of the water used at the farm. In the three AquaETreat project years (2005-2007), production decreased in Maribrin as the manager chose to market fish at a heavier harvest size. Instead of selling fish at 350 g average weight, the farm now sells fish up to 1.3 kg. The production period is extended to four years but the medium selling price, at 8.7 €/kg, is higher and there is less competition.

Conclusion

At Maribrin, the water treatment for an annual production of 60 tonnes of Sea Bass and Sea Bream produces 30-50 kg/day of sludge containing 15 - 20% dry matter. The operating cost of the system is 0.26 €/kg of fish produced, or 3% of the selling price.

Looked at in isolation, 3% of the selling cost for water treatment is not sustainable in competitive markets. However, the treatment has returned the water to a quality similar to that of 'new' water and the farm could now increase production. The value of that increased production needs to be considered. There may also be other incentives or imperatives to be considered in deciding whether to treat fish farm effluent, the degree of treatment to apply and what methods to use.

When this level of treatment is applied to the whole farm, the final daily sludge volume will be a close to 200 kg. The farmer still needs to dispose of this material. During the AquaETreat project, trials were completed using sludge as a fertiliser for the culture of plant crop species (see Fish Sludge: Valuable Resource or Expensive Waste? in this manual). The trials gave promising results but have not yet reached the point when income-generating or zero-cost disposal can be assured.

2. Murgat

Effluent treatment system

Mechanical filtration

Three filters had already been installed prior to the AquaETreat project. The first treats the water at the outlet of the pre-growing unit while the second and third are positioned at the middle and at the outlet of the on-growing units, where the filtered water from the first drum filter is re-used. For the purposes of this chapter, we will consider the cost of filter(s) that meet the following characteristics:

- volume of effluent to be treated: maximum 600 l/s
- concentration of suspended solids (SS): approximately 4 mg/l
- mesh size to be used: 80 microns (μm)

Further concentration

The backwash water from the filters passes through thickening cones. From there, the sludge is pumped to a silo where it is further concentrated by settlement. At that point, the sludge flow rate is around $3 \text{ m}^3/\text{h}$ (approximately 1 l/s). The supernatant from the silo, with a flow rate of $15 \text{ m}^3/\text{day}$ (0.2 l/s) and a concentration around 780 mg/l SS, is treated in two separate constructed horizontal and vertical wetlands. The wetlands achieve significant reduction of dissolved nutrients before water is released into the river.

The sludge from the silo is further concentrated in a settling tank where the supernatant is also treated in a wetland. This raises the SS concentration from 6 – 8% to 14%.

At present, the sludge is stored for 6 - 12 months and is collected by local farmers for use as fertiliser. Analysis shows that the sludge has good agronomic value.

Cost of the system

Capital costs (early 2007)

	€
- drum filter(s) in 304 stainless steel without tank	45,000.00
- civil engineering, electrical work, pipes, etc	15,000.00
- cones and silo	5,000.00
- constructed wetlands (x 3) in existing ponds, local plants	21,000.00
Total	<u>86,000.00</u>

Annual running costs

- depreciation (12.5%, 8 years)	10,750.00
- maintenance (3% of capital cost)	2,580.00
- personnel	6,400.00
- electric power	1,780.00
- wetlands	400.00
Total	<u>21,910.00</u>

Fish Production

The farm produces around 600 tons of Brook Trout, Brown Trout, Rainbow Trout and Arctic Char per year. The average selling price is 3.96 €/kg.

Conclusion

At Murgat fish farm, the whole effluent treatment of 600 l/s for an annual fish production of 600 tonnes produces 3 m³/day (0.03 l/s) of sludge containing 93% water. The running cost is 0.036 €/kg of fish produced, or 0.9% of the selling price.

3. Højhøy

Wastewater treatment system

Mechanical filtration

The fish farm is working as a semi-closed system, using around 15 l/s of new (river) water containing 6 – 8 mg/l SS. The farm produces around 100 tonnes/year of Rainbow Trout. The same amount of water, with a suspended solids concentration of 2.5 – 5 mg/l, is returned to the river via a lagoon.

The effluent, 600 l/s, passes from the tanks (1200 m³) through two drum filters and finally through a large biological filter (12 tanks of about 10 m³ each). This also acts as a trap for the particles that have passed through the

drum filter. One biological filter is washed every day. Each drum filter and each biofilter produces around 0.4 l/s of sludge with a suspended solids content respectively of 350 – 500 mg/l and 1250 – 2000 mg/l.

Further concentration

The sludge is further concentrated in two tanks and another biological filter, and put in a sedimentation tank where it reaches a concentration of 2 - 3 g/l. Finally, it is pumped to a sludge pond.

An estimation of the treatment cost is difficult for a farm working as a semi-closed circuit because it is almost impossible to assign the treatment devices distinctly to a) reuse of the water and b) treatment before water is released to the river.

The cost of treatment is calculated below on the basis of the cost of the equipment that was either modified during the project, or added to the structures that were already working at the start of the project.

Cost of the system

<i>Capital costs</i>	€
- alteration to drum filters	10,000.00
- sieve concentrator	27,000.00
- addition to aeration system	19,000.00
- biofilter including media	6,000.00
- civil works	3,000.00
	<hr/>
Total	65,000.00

Annual running costs

- depreciation (10%, 10 years)	6,500.00
- maintenance (3% of capital cost)	1,950.00
- personnel (130 hours at 30 €/h)	3,900.00
- electric power	375.00
	<hr/>
Total	12,725.00

Fish Production

With this system, the fish farm produces 120 tons of trout with a median selling price of 2.2 €/kg.

Conclusion

At Højhøy fish farm, the annual production of 120 tons gives 26m³/day of sludge at 97% of water before deposit in the ponds. The running cost of the system represent 0.12€/Kg of fish produce or 4,8% of the selling price.

4. Cost of Effluent Treatment: general conclusions

The cost of the treatment systems varies between farms and is linked to local conditions, including, for example, to the species reared, the rearing system used, the space available, and the treatment techniques chosen. Great care has to be taken prior to any investment project decision and the knowledge accumulated during the AQUAETREAT project will help other farmers in their choice.

For all farms, other site-specific factors have to be considered:

- What will be the income from the eventual re-use of the sludge?
- What value can be given to reuse of the treated water by the fish farmer?
- What value can be placed on the environmental benefit to the community?
- Is water treatment a pre-requisite for the farm to exist?
- Is there a benefit for the community in operating to best management practices (BMP)?
- Is there a benefit in BMP such as lower insurance cost or reduced monitoring by Competent Authorities?

Last, but not least, fish farmers will need economic and technical support to implement and adapt effective water treatment systems.

12. Future development and trends

V. Zonno

As the world population and economy grows, water becomes an increasingly scarce commodity.

Fish farming takes place across Europe in a variety of environments and is a big user of either freshwater or seawater. Aquaculture, along with all animal husbandry, produces effluents that contain dissolved and particulate nutrients, which can lead to ecological disturbances in the receiving ecosystem.

The European Union is therefore committed to promoting and encouraging the sustainable use and efficient management of water resources across the continent. Innovative projects that help industry to optimise water use and reduce the impact on the environment are a part of that commitment.

There are three strategies at farm level to improve water quality and to reduce effluent nutrient load: improved farm management, effluent treatment and water reuse. The application of each strategy, either individually or in combination, can significantly reduce effluent concentrations.

The provision of optimal rearing conditions for fish, to reduce stress and to promote optimal growth, is the first management strategy to limit the nutrient discharge. New feed formulations for improving the physical removal of particulate wastes are needed; the application of binders in fish diets is a highly promising approach.

Mechanical filtration of effluent treatment is established practice in both flow-through and recirculation farms. Further development is needed to improve filter efficiency and the processing of the micro-screen backwash water (wet sludge). Greater mechanical dewatering and more effective and economic use of



Figure 1: lagoon (photo STM aquatrade)

coagulation/flocculation chemicals can be developed.

Research trials with polymers of natural origin which do not chemically alter the sludge or the clarified water will pay dividends.

The promising results from constructed wetlands and algal and zooplankton growth ponds merit further development. Clearer understanding of the processes involved is needed to optimise the use of wetlands. The gaps in understanding inhibit making best use of these systems. The effects of seasonal variation in performance needs investigation to underpin the considerable investment required to use these methods on a farm scale. Application of constructed wetlands in marine environments needs also to be better demonstrated. Employment of algal ponds, as demonstrated in this manual, is a useful tool for water-use optimisation in land-based marine aquaculture, and allows the production of high quality fish while maintaining animal welfare. Further knowledge is needed for application on a commercial scale and in differing climate conditions.

For partial water reuse, two treatment methods are currently used: trickling filters for low flow situations, since high pumping head is required; and moving bed bio-filters for high flow situations. Both of these approaches use significant energy and warrant development to reduce energy use and simplification to reduce capital investment. Both types of biofilter have improved performance in recent years and, with more attention, can be expected to be further improved.

Improved sludge thickening, stabilisation, storage and reuse are needed in order to achieve cost effectiveness for this by-product as a soil conditioner or fertiliser in agriculture. The long term effect of disposing marine sludge on the land must be addressed to give confidence in its use.

Alternatives for sludge reuse, including composting, heat production through combustion or pyrolysis, for methane or phosphorous recovery, as a fibre source or as a growth medium for worm culture, are possible but not yet sufficiently understood to be commercially exploited.

The economic aspects of most treatment methods have not been well documented until now; an area where reliable data are imperative for farmers to make decisions over investment.

The treatment of effluent water from aquaculture poses different challenges to other better understood fields of water treatment. The aquaculture industry is still young and serious aquacultural engineering is even younger as a field of study. The rate of progress has been high and with further investment in suitable research projects, that progress rate can be maintained and enhanced.

The significant reductions sought for the environmental impact of aquaculture can only be delivered on the back of improved technology. This is an area where investment of public funds will deliver results in the form of environmentally friendly and sustainable aquaculture.

Annex: Glossary

agar

A gelatinous product of seaweed.

algae (pl; alga sing.)

Any of a large group of non-vascular, mainly aquatic, plants without flowers or cones, and capable of photosynthesis. Marine algae are also known as 'seaweeds'.

assimilation

The conversion into a similar substance; especially conversion by a living organism of extraneous material into fluids and tissues identical with its own.

autotrophic

Requiring only simple inorganic compounds for nutrition.

availability

Organisms have evolved to utilise specific nutrients for their metabolism and, further, to utilise only certain forms of those nutrients. For example, nitrogen (N) 'availability' refers to the degree to which nitrogen is present in a form (for example as nitrate, nitrite or ammonia) that can be metabolised by the organism concerned.

backwashing

A method of cleaning filters. In sand filters backwashing involves reversing the water flow to lift off the settled solids. In a drum filter (microsieve), backwashing involves spraying the filter mesh with high-pressure water jets in the opposite direction to the effluent flow. The sludge removed from the filter mesh is washed down a collection trough to a collection vessel.

biomarkers

Structural or enzymatic proteins whose concentration or activity, measurable in a biological system, is influenced by exposure to specific pollutants.

BOD₅

(Biological / Biochemical Oxygen Demand) The quantity of oxygen utilized in the biochemical oxidation of organic matter during a five-day period. The sample is maintained throughout 5 days at 20°C and in the dark. The BOD₅ provides an indication of the level of pollution in a biological system: the higher the BOD₅, the higher the level of pollution is indicated. Compare **COD**.

coagulation

The process of decreasing or neutralising the electrical charge or zeta potential on suspended particles. Acting like magnets, similar electrical charges on small particles in water cause the particles to naturally repel each other. The small ('colloidal') particles are thus kept apart, and in suspension. Coagulation refers to any physical or chemical process which removes or reduces these charges, thus causing the particles to be more tightly attracted.

COD

(Chemical Oxygen Demand) A measure of the amount of oxygen taken up under standard conditions by the organic material in a sample of water. COD provides an assessment of the degree of organic pollution of water. A less specific measure than BOD₅, COD measures all oxidation of the organic matter, both chemical and biological.

colloid

A non-crystalline substance consisting of ultramicroscopic particles (often single large molecules). Colloids may be dispersed in other substances to form a viscous solution with special properties.

Competent Authority

Usually the government department or other body responsible for dealing with a particular issue. It is competent in the sense of having legal power and responsibility for specified duties.

dibromophenol

An anti-bacterial agent.

dimethyl sulphonioacetate (DMSP)

DMSP is found in certain plants, including marine algae, and is required for their metabolism. Organisms which feed on diets with a high DMSP content can accumulate it, and there is evidence of increased growth rates, vigour and stress-resistance in animals cultivated on such diets. Although DMSP is itself odourless and tasteless, one of its breakdown products, dimethyl sulphide (DMS), is responsible for taint (taste and odour) in some seafood products after death and during processing.

dissimilation

The action of making dissimilar; destructive metabolism; catabolism; the breaking down of complex organic molecules or tissue by living organisms into simpler chemical forms, with the release of energy.

dry weight

The material left after the removal of water from organic matter, obtained by heating to constant weight in an oven at 90-95 °C. Removal of (variable amounts of) water allows direct comparison between values expressed in terms of dry weight. See also **suspended solids**.

dw

See dry weight.

ecophysiological

Describing interrelationships between an organism's physical functioning and its environment.

effluent

A stream of liquid flowing out; especially waste discharged from an industrial process. With reference to aquaculture, a waste stream consisting of waste metabolites, unused feed, dissolved nutrients and extraneous matter carried in the water.

epiphyte

A plant that grows on the surface of another plant. The relationship is physical but neither parasitic nor symbiotic; there is no physiological relationship between the two plants.

flocculation

The process of bringing together microfloc (coagulated) particles to form large agglomerations. This is achieved by physical mixing or through the binding action of flocculants, such as long chain polymers.

flux

A rate; a unit of quantity (weight, volume or other) per unit time.

fresh weight

The weight of a substance or sample in its natural state, that is, with its natural (and variable) water content included.

gabion

A wire basket or container filled with stones or earth for use in engineering or fortification.

head loss

The reduction in height of water that provides the force to move water from one place to another.

head of water

The vertical height of water over a given basal area that provides pressure for the movement of that water from a higher to a lower position.

heterotrophic

A type of nutrition that depends on an external energy supply contained in complex organic compounds.

Imhoff cone

A graduated cone-shaped plastic or glass container used to measure the amount of suspended solids that will settle out of a liquid in a given period of time.

integrative

Tending to integrate.

Kjeldahl analysis

A widely used technique to determine the total nitrogen content of a sample. See also **Total Kjeldahl Nitrogen**.

laminar flow

A flow that is smooth and regular, not turbulent, the direction of the flow at any point remaining constant as if the fluid were moving in a series of layers of different velocity sliding over one another without mixing.

macroscopic

Visible to the naked eye.

mean

Strictly, a statistical term, equivalent to 'average' throughout the manual.

micron (μm):

a unit of length; one millionth of a metre (10^{-6} m) or one thousandth of a millimetre (10^{-3} mm).

monomer

A small molecule which joins with other monomers to form a polymer.

nutraceutical

A term used to describe "functional foods" (for example, antioxidants and pigments). Nutraceuticals are claimed to have health-promoting properties. They tend to be available as food supplements rather than as licensed drugs. There are demonstrable physiological effects from some of these products, though there is debate about the effects of others. The global market for nutraceuticals is large and growing rapidly. Many of the bioactive compounds involved are obtained from micro-organisms, including from micro-algae; others may be derived from certain by-products (for example chitin) from fish and shellfish processing. Hence, aquaculture offers a potentially valuable source of the compounds.

nitrogen (N)

An essential nutrient for living organisms; nitrogen is a component of organic molecules such as proteins. In natural systems, nitrogen occurs in many forms, and the transformations between the different forms are mediated by complex chemical and biological processes. The particular pathway by which a nitrogen compound is transformed depends on local soil and water

conditions (acidity, microbial populations, extent of waterlogging and oxygenation, local geology and so on). In lakes, most nitrogen is in the nitrate (soluble, NO_3^-) form. It is measured in milligrams per litre (mg/l). Elevated levels of nitrates/nitrogen are often caused by over-application of fertilizers that leach into water bodies. The important (and inorganic) nitrogenous compounds in the context of aquaculture effluent treatment are nitrite (NO_2^-), nitrate (NO_3^-), ammonia (NH_3), and ionized ammonia (NH_4^+). These may be used by plants as nutrients or may be reduced to other nitrogenous forms by bacteria (denitrification). As this implies, different forms of nitrogen have different properties; for example are more or less soluble in water, more or less available for bacterial or other transformation, more or less toxic. It is important to know as much as possible about the forms in which nitrogen is present in a system, and how they can be manipulated, in order to optimise effluent management decisions. For example, NH_3 and NH_4^+ commonly occur together in water, but NH_3 is the more toxic form to fish. The proportion of the two forms depends mainly on pH. Different analytical methods measure different forms of nitrogen. Most of the time, chemical analysis provides a measurement expressed as Total Ammonia Nitrate (TAN), which is the amount of nitrogen present in both NH_3 and NH_4^+ forms. For other nitrogen-related notations used in the manual, refer to Conventions and Abbreviations. See also **Total Nitrogen** and **Kjeldahl analysis**.

organic

A compound which contains carbon and is not immediately available to plants.

osmotic regulation

Regulation by the process of osmosis. Osmosis is the diffusion of a solvent (for example, water) through a semi-permeable membrane, from a region of high solvent concentration (dilute solution or pure water, for example) to a region of lower solvent concentration (more concentrated solution or a solution, for example).

photosynthesis

A process in plants whereby carbon dioxide is converted into organic compounds using the energy of sunlight absorbed by chlorophyll.

phycocolloids

Colloids derived from seaweeds (marine algae).

polymer

Having a chemical formula that is an exact multiple of another, composed of the same elements in the same proportions. Compounds formed from monomers.

polymeric

Pertaining to polymers. See **polymer**.

prostaglandin

Any of a group of cyclic fatty acids with effects similar to those of hormones.

quiescent

Quiet, still, non-turbulent. Applied to aquaculture, quiescent describes water behaviour.

rheological

Pertaining to the deformation and flow properties of matter.

SD (standard deviation)

A statistical term. Gives an indication of the dispersion of measured values. It is the mean difference from the mean of all the values that have been used to calculate the mean

sedimentation

The deposition of particles from transporting agents such as water; the settlement of particles at the bottom of a body of water under the force of gravity.

settling solids, settleable solids

The volume of suspended solids (SS) in a 1-litre water sample that accumulates in the bottom of an Imhoff cone after a standard period of time (commonly 2 hours). The Imhoff cone is graduated in such a way that the volume of settled solids, in millilitres, is read directly off the cone at the height level with the top of the settled solids. Thus the reported volume includes solids and water. Settling solids are reported in millilitres per litre (ml/l). It is possible to measure settling solids without an Imhoff cone: measure the volume (ml) of suspended solids (including water) present in 1 litre of effluent that will settle out in a period of 2 hours when the effluent is held motionless.

sludge

A thick suspension of fine particles or gel in a liquid; especially as one formed as waste in any industrial or mechanical process.

stool

The base of a tree or shrub, cut back to ground level to encourage re-growth.

supernatant

Of a fluid: lying above a solid residue that has been separated out by precipitation or centrifugation; also, a fluid floating above a denser fluid.

suspended solids (SS)

Solid particles floating or suspended in water. They can be removed by filtration or settlement. The content of SS in water is determined by weighing a dry filter paper of a specified pore size (0.5 – 1.2 μm), pouring a carefully measured volume of water (typically one litre) through the filter, then weighing the filter again after drying it to constant dry weight. The gain in weight is a dry weight (dw) measure of the particulates present in the water sample, expressed typically in milligrams per litre (mg/l). Note that if the

water contains an appreciable amount of dissolved substances, as would be the case when measuring SS in seawater, these will add to the weight of the filter as it is dried. Therefore it is necessary to "wash" the filter and sample with de-ionized water after filtering the sample and before drying the filter. Failure to add this step will invalidate the results as the weight of salts left on the filter during drying can easily exceed that of the suspended particulate matter.

TAN

Total Ammonia Nitrogen: see **nitrogen**.

Total Kjeldahl Nitrogen (TKN)

The sum of organic nitrogen and ammonia in a water body, as determined by the Kjeldahl method of analysis. TKN is measured in milligrams per litre (mg/l). High measurements of TKN typically result from sewage and manure discharges to water bodies. See also **nitrogen**.

Total Nitrogen (TN)

The sum of the various forms in which nitrogen is present in water: nitrate (NO_3^-), nitrite (NO_2^-), organic nitrogen and ammonia ($\text{NH}_3 / \text{NH}_4^+$) (all expressed as N). Nitrate and nitrite are soluble while a part of the Total Ammonia Nitrogen (TAN) is linked to the SS and can be removed through mechanical filtration. See also **nitrogen**.

Total Phosphorus (TP)

Total phosphorus includes the amount of phosphorus (P) in solution (reactive) and in particle form as orthophosphate (PO_4) + polyphosphate + organic phosphate. Ortho- and polyphosphate are soluble and thus cannot be filtered. Organic phosphate forms part (around 2%) of the suspended solids. The presence of metals such as iron (Fe) and aluminium (Al) can lead to the formation of large particles which are easily filtered. Phosphorus is an essential nutrient for the growth of organisms, and is commonly the limiting factor in the primary productivity of surface water bodies. Agricultural drainage, wastewater, and certain industrial discharges are typical sources of phosphorus in water, and can contribute to the eutrophication of surface water bodies. Measured in milligrams per litre (mg/l).

Van't Hoff's Law

A statement in physical chemistry: the effect of a change in temperature on a system in equilibrium is to shift the equilibrium in the direction that acts to nullify the temperature change. According to Van't Hoff's law, an increase in temperature will cause an increase in the rate of an endothermic reaction (a reaction in which heat is absorbed).

zeta potential (ζ)

The electrostatic potential generated by the accumulation of ions at the surface of a (colloidal) particle, organized into an electrical double-layer. Knowledge of this value enables prediction of flocculation properties and suitable flocculating agents.

Annex: Contact points for information

Acierno, R.

Marine Aquaculture and Fisheries Research Centre, Department of Biological and Environmental Science and Technology, Università del Salento, Via Prov. Lecce-Monteroni 73100 (ITALY).
raffaele.acierno@unile.it

Blancheton, J. P.

IFREMER, Station de Palavas, Chemin de Maguelone, 34250 Palavas Les Flots, France.
Jpblanch@ifremer.fr

Bressani, G.

Marine Aquaculture and Fisheries Research Centre, Department of Biological and Environmental Science and Technology, Università del Salento, Via Prov. Lecce-Monteroni 73100 (ITALY).

Ceruti L.

IFREMER, Station de Palavas, Chemin de Maguelone, 34250 Palavas Les Flots, France.

Chadwick, D.

Manures and Farm Resources Team, Institute of Grassland and Environmental Research, North Wyke Research Station, Okehampton, Devon EX20 2SB UK.
david.chadwick@bbsrc.ac.uk

Claricoates, J.

School of the Environment and Society, Margam Building, Swansea University, Singleton Park, Swansea SA2 8PP UK.
Tel: + 44(0)1792 602029
j.claricoates@swansea.ac.uk

Donaldson, G.

Fenswood Farm, University of Bristol, Long Ashton, Bristol BS41 9AE UK.
guy.donaldson@bristol.ac.uk

Loix, B.

STM aquatrade S.r.l., Contrada Collina, 35, 62022 Castelraimondo (MC), Italy.
Tel: +39 (0)737 641140 – 640260
Fax: +39 (0)737 640622
www.acquacoltura.com

Lovitt, R. W.

45 Sketty Road, Swansea SA2 0EN.

Tel +44 (0)1792 298381, +44 (0)1792 295709, +44 (0)7973 814996

r.w.lovitt@swansea.ac.uk

Proffitt, G.

Swansea University, Singleton Park, Swansea SA2 8PP UK.

Tel +44 (0) 1792 205 678

gproff@aol.com

Read, N.

Alderley Trout Ltd., Wotton under Edge, Gloucestershire GL12 7QT UK.

Tel: +44 (0)1453 521929

nicholas.read@btconnect.com

Roque d'orbcastel, E.

IFREMER, Station de Palavas, Chemin de Maguelone, 34250 Palavas Les Flots, France.

emmanuelle.roque@ifremer.fr

Sourget, S.

IFREMER, Station de Palavas, Chemin de Maguelone, 34250 Palavas Les Flots, France.

Vilella, S.

Marine Aquaculture and Fisheries Research Centre, Department of Biological and Environmental Science and Technology, Università del Salento, Via Prov. Lecce-Monteroni 73100 (ITALY).

sebastiano.vilella@unile.it

Zonno, V.

Marine Aquaculture and Fisheries Research Centre, Department of Biological and Environmental Science and Technology, Università del Salento, Via Prov. Lecce-Monteroni 73100 (ITALY).

vincenzo.zonno@unile.it

Annex: Project Partners

IAG partner:

- Federation of European Aquaculture Producers



SME partners:

- Comité Interprofessionnel de Produits de l'Aquaculture



- STM Aquatrade Srl



- Maribrin Srl



- Højhøg Dambrug I/S (AquaPri)



RTD performers:

- Università di Lecce
(Project coordinator)



- University of Wales Swansea

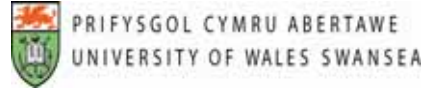

- Institut Français de Recherche pour l'Exploitation de la Mer



- Institute of Grassland & Environmental Research

