

# ICES WGBIOP REPORT 2016

ICES ADVISORY COMMITTEE

ICES CM 2016/SSGIEOM:08

REF. SCICOM & ACOM

## Report of the Working Group on Biological Parameters (WGBIOP)

10–14 October 2016

Monopoli, Italy



**ICES**  
**CIEM**

International Council for  
the Exploration of the Sea

Conseil International pour  
l'Exploration de la Mer

## **International Council for the Exploration of the Sea Conseil International pour l'Exploration de la Mer**

H. C. Andersens Boulevard 44–46  
DK-1553 Copenhagen V  
Denmark  
Telephone (+45) 33 38 67 00  
Telefax (+45) 33 93 42 15  
[www.ices.dk](http://www.ices.dk)  
[info@ices.dk](mailto:info@ices.dk)

Recommended format for purposes of citation:

ICES. 2016. Report of the Working Group on Biological Parameters (WGBIOP), 10–14 October, 2016, Monopoli, Italy. ICES CM 2016/SSGIEOM:08. 106 pp.

For permission to reproduce material from this publication, please apply to the General Secretary.

The document is a report of an Expert Group under the auspices of the International Council for the Exploration of the Sea and does not necessarily represent the views of the Council.

© 2016 International Council for the Exploration of the Sea

## Contents

---

<b>1</b>	<b>Executive summary</b> .....	<b>1</b>
<b>2</b>	<b>Terms of Reference</b> .....	<b>3</b>
<b>3</b>	<b>Summary of Work plan</b> .....	<b>4</b>
<b>4</b>	<b>List of Outcomes and Achievements of WGBIOP in this delivery period</b> .....	<b>5</b>
4.1	ToR a) .....	5
4.2	ToR b) .....	5
4.3	ToR c).....	5
4.4	ToR d&e).....	6
<b>5</b>	<b>Progress report on ToRs and work plan</b> .....	<b>7</b>
5.1	ToR a) Assess and suggest potentially new biological parameters for single-stock and IEA models.....	7
5.1.1	Progress during WGBIOP 2016.....	7
5.1.2	Work plan for 2016-2017 .....	8
5.1.3	Deliverables for WGBIOP 2017 .....	8
5.2	ToR b) Evaluate quality of biological parameters: Issues, quality indicators and guidelines .....	9
5.2.1	Progress during WGBIOP 2016.....	9
5.2.2	Work plan for WGBIOP 2016-2017.....	11
5.2.3	Deliverables for WGBIOP 2017 .....	12
5.3	ToR c) Plan studies, workshops and exchange schemes and other intersessional work related to interpretation and quality assurance of data on stock-related bio-logical variables and review their outcomes. ....	12
5.3.1	Progress during WGBIOP 2016.....	12
5.3.2	Work plan for WGBIOP 2016-2017.....	13
5.3.3	Deliverables for WGBIOP 2017 .....	14
5.4	ToRs d and e) Address requests for technical and statistical recommendations/advice related to biological parameters and indicators and continue development of tools for the exchanges and workshops.....	14
5.4.1	Progress during WGBIOP 2016.....	14
5.4.2	Calibration tool (ToR e).....	17
5.4.3	Workplan for WGBIOP 2016-2017.....	18
5.4.4	Deliverables for WGBIOP 2017 .....	19
<b>6</b>	<b>WGBIOP in context of Liaison Meeting and Regional Coordination Meetings, ICES and GFCM</b> .....	<b>20</b>

7	Revisions to the work plan and justification .....	21
8	Next meeting.....	22
	Annex 1: List of participants.....	23
	Annex 2: Recommendations from WGBIOP .....	25
	Annex 3: Strengthening links to groups using biological parameters .....	26
	Annex 4. Tables of quality indicators suggested as support for benchmarks .....	35
	Annex 5. Review of past workshops and exchanges .....	57
	Annex 6. Draft resolutions for suggested exchanges and workshops .....	70
	Annex 7. Past workshops and exchanges and other workshops with relevance for biological parameters .....	85
	Annex 8 Suggested changes to the recommendation system .....	92
	Annex 9 Minutes from web meeting with ICES re-calibration tool .....	96
	Annex 10 Full list of improvements for a calibration tool.....	98
	Annex 11 List of annually updated tables and documents.....	102
	Annex 12 Task sharing options.....	103
	Annex 13 References.....	105

## 1 Executive summary

---

This was the second interim year for the multi-annual Terms of References (ToRs) for the Working Group on Biological Parameters (WGBIOP). ToRs a and b further explored the best practice of achieving quality assured assessments of new and existing biological parameters for both single- and integrated stock assessment. ToRs c, d and f were the generic ToRs for the group handling the reviewing of calibration exercises on biological parameters, their outcomes and recommendations for such actions, including a continuous development of tools for calibrations.

Under ToR a, a web meeting was held between WGBIOP and WKIDEA in order to identify potential interfaces between WGBIOP and the Integrated Ecosystem Assessment (IEA) data end-users. Given the wide range of potential data currently used in the integrated trend analysis in the IEA's, a prioritised list of data were agreed to be provided to WGBIOP from WKIDEA. WGBIOP will then review the list of wanted data and assess where the group can provide data links to the ICES Data Centre with associated quality statements, and identify the 'white spots' for where data currently are missing and provide guidance on how to gather such data where possible. It was decided to use the IEA on the greater North Sea ecoregion as the first case to handle in this new interface.

While WGBIOP was scoping out new data in close collaboration with the IEA groups, the existing and applied data were also a key part of WGBIOP. Under ToR b a close link to the benchmark process in ICES was discussed, this year by formulating quality indicators, specifically focusing on statistical indicators, production of guidelines on quality indicators, and at which point these can be inserted in the ICES benchmark process.

ToR c evaluated results of calibration of data for stock assessment and drafted resolutions for workshops and exchanges to be approved for 2017 and onwards where appropriate. ToR d reviewed the current recommendation system in ICES and drafted a suggestion for a more operational approach to be discussed. On a more technical aspect, ToR e this year outlined a suggestion for the implementation in ICES of a web-based calibration tool.

**Administrative details****Working Group name**

WGBIOP

**Year of Appointment within the current cycle**

Year 2

**Reporting year within the current cycle (1, 2 or 3)**

Year 2

**Chair(s)**

Francesca Vitale, Sweden

Lotte Worsøe Clausen, Denmark

Pedro Torres, Spain

**Meeting venue**

Monopoli, Bari, Italy

**Meeting dates**

10–14 October 2016

## 2 Terms of Reference

---

- 1) Identify and assess new biological parameters as input to integrated ecosystem assessments and continue the development of methods and guidelines for best practice in the analysis of biological samples providing such parameters, meeting end-user needs.
- 2) Evaluate quality of biological parameters: issues, quality indicators and guidelines.
- 3) Plan studies, workshops, and exchange schemes or other intersessional work related to interpretation and quality assurance of data on stock-related biological variables and review their outcomes.
- 4) Address requests for technical and statistical recommendations/advice related to biological parameters and indicators.
- 5) Update and further develop tools for the exchanges and workshops (e.g. WebGR, other statistical tools, and age readers/maturity stagers' forum).

### 3 Summary of Work plan

---

Year 1	Consolidate WGBIOP workplan (ToR 1). Initiate the collation of a) information related to potential new biological parameters; b) Benchmark Issue Lists; c) Guidelines. ToR 5-7 are generic ToRs and will be dealt with on a yearly basis in WGBIOP
YEAR 2	<b>IMPLEMENT THE QUALITY INDICATOR FOR CURRENT BENCHMARKS; DEVELOP METHODS/GUIDELINES FOR BEST PRACTICE FOR THE COMPUTATION OF THE NEW REQUIRED BIOLOGICAL PARAMETERS; FURTHER DEVELOP THE GUIDELINES IN TOR B.</b>
Year 3	Review the current status of issues, achievements and developments that falls under the remit of WGBIOP, identify future needs in line with the ICES objectives and Science Plan and the wider marine environmental monitoring and management within Europe and propose a future/alternative work plan



## **4 List of Outcomes and Achievements of WGBIOP in this delivery period**

---

During the first year of WGBIOP the intersessional work under each ToR has been carried out by designated subgroups. The deliverables defined during the 2015 meeting were reported on the first day of the 2016 meeting. Below a short summary of the work up to the meeting in 2016 is provided by ToR, and the further development during the meeting is described in Chapter 4.

The overall aim for WGBIOP this year was to critically assess workload in relation to the achieved value associated with exchanges and workshops, but also the more technical aspects of the ToRs. The provision of biological parameters for Integrated Ecosystem Assessments (IEAs) was discussed in terms of an overall strategy together with WKIDEA.

### **4.1 ToR a)**

The deliverable for 2016 was the compilation of a database holding existing data which could be input in IEAs, their availability/accessibility through ICES, DCF, etc. Further development of the database was done during WGBIOP 2016, where emphasis was put on the quality in terms of sampling and estimation to operationalize the biological parameters beyond age and maturity. The database will provide an overview of the sampling, the information available in the data, how to assess the uncertainty in the data and where to find the data (contact persons). The database contents were discussed with potential end-users (e.g. WGSAM, the multispecies working group) and with off-set. In this discussion specified questions for regional IEA groups were drafted and a meeting with WKIDEA was arranged to happen during the WGBIOP meeting in 2016.

### **4.2 ToR b)**

After the meeting in 2015 stock coordinators were asked if they had suggestions on biological parameters for WGBIOP. The replies and actions taken by the stock coordinators are reported. During the 2016 meeting a compilation and evaluation of the issue lists put forward by the assessment WGs for upcoming benchmark species in 2017 and 2018 was carried out. Within these, the NEA mackerel and sole 7d stocks were case studies for the 2016 meeting. The quality indicators definitions were reviewed and amendments were done where needed as well as a suggestion of how and where these would be a valuable input into the ICES benchmark flow.

### **4.3 ToR c)**

The updated guidelines on 'fast-track' calibrations were presented for ICES chairs and with the ongoing reformation of the benchmark process in mind (a 3-4 year process), the ability to provide fast responses to sudden arising issues with age-data appears timely. The possibility for task sharing between laboratories in all regions were discussed and an approach was outlined. The CRR 'Handbook of fish age estimation protocols and validation methods' was submitted for publication and will in future be part of the preparatory work for exchanges and workshops since these often need input on available validation studies and/or techniques.

#### **4.4 ToR d&e)**

Prior to the meeting, this subgroup explored the market for online calibration tools to compare the features of the current tool WebGr and the improvements needed for this tool with what is available online. ILVO (Institute for agricultural and fisheries research, Belgium) was invited to present their system 'Smart Fish' at the 2016 WGBIOP meeting in order to discuss whether this tool would be operational under the auspices of ICES as a calibration tool in future.

## 5 Progress report on ToRs and work plan

---

### 5.1 ToR a) Assess and suggest potentially new biological parameters for single-stock and IEA models.

This subgroup has two main objectives:

- identifying new or emerging biological parameters to support multispecies modelling and integrated ecosystem assessments (IEA)
- assessing their quality in terms of sampling and estimation.

In order to meet these objectives, the chairs of several Expert Groups were contacted after the WGBIOP 2015 and a list of parameters has been compiled. For achieving the final objective, a database will be set up to document key parameters and related information such as available datasets, computational methods, uncertainty estimates and quality indicators.

The new parameters include: Stomach contents data, body condition, hydroclimate, predation, tagging, biogeochemistry, life history parameters. Moreover, some future/emerging parameters were also identified, including lower trophic levels (phytoplankton/zooplankton abundance), ichthyoplankton (qualitative and quantitative data), recruitment, species spatial patterns, hydroacoustic data, climate/environmental data. During the discussion, the need for prioritisation of the parameters for the IEA was highlighted.

For the web meeting with WKIDEA during WGBIOP, some open questions were identified:

- What data are you actually looking for to apply in IEA?
- We will provide a list of known data sources, but
  - How can we – in your view – be operational?
  - Where are we needed in terms of a calibrated approach to analysis and use of new/existing data?
- We have developed guidelines for best practice for the provision of calibrated age data. Will such guidelines for new required biological parameters be useful/realistic?

#### 5.1.1 Progress during WGBIOP 2016

During the 2016 meeting, a web meeting was held between WGBIOP and WKIDEA in order to identify potential interfaces between WGBIOP and the IEA data end-users. Both groups agreed that a closer link between WGBIOP (which can provide insight on available data, and their quality in terms of sampling and uncertainty) and IEA groups would facilitate a much smoother and strategic approach for the development of regional IEAs. Often datasets exist but are unknown to the IEA groups. WKIDEA highlighted the importance of having knowledge of existing datasets that they are currently not aware of.

Given the wide range of potential data currently used in the integrated trend analysis in the IEA's, a prioritised list of data were agreed to be provided to WGBIOP from WKIDEA. WGBIOP will then review the list of wanted data and assess where the group can provide data links to the ICES Data Centre, with associated quality state-

ments. WKIDEA anticipates that the ICES Data Centre will process the data and provide estimates for IEA groups. WGBIOP can identify the 'white spots' where data are currently missing and provide guidance on how to gather such data where possible. WKIDEA will provide a list of current data requirements for the short/medium term, while for the longer term, potential new requests from stakeholders can be expected and added to the data requirements.

It was decided to use the IEA on the greater North Sea ecoregion as the first case to try in this new interface. The IEA group initially prioritises the availability of a benthic macrofauna dataset as well as the standard datasets of plankton occurrence (magnitude and composition), bio-chemical data (temperature, salinity, nutrients, etc.), fish stock composition and size. The more classic datasets were asked to be evaluated in terms of the quality of monitoring and uncertainty of parameter estimations (e.g. length, weight, maturity, age, species, etc.). WGBIOP asked WKIDEA about the demand for stomach data. WKIDEA regards those as important link between e.g. benthic and demersal communities. There is still the need to know, however, what the current status is and how continuous data collection is. In terms of time-series length, the desirable length is 30 years; however, any available dataset will be considered, regardless of time-series length.

WGBIOP is making an effort to strengthen the link to groups using biological parameters, e.g. the WKIDEA as reported above, but also WGSAM and other groups, which work with biological parameters with different approaches. Annex 3 outlines the progress made for this aim. The ToR a) subgroup dealt specifically with stomach data collection under Annex 3, summarising latest efforts in compiling existing information and sampling plans.

### **5.1.2 Work plan for 2016–2017**

As stated in the WGBIOP 2015 report, there are very many potential new biological parameters. This makes it vital to have a process for deciding which are the highest priority. This process needs to be developed with the users of the biological parameters, for example: WKIDEA identified that foodweb coverage makes obtaining North Sea benthic macrofauna data one of their priorities. A measure of how many uses a parameter has is likely to be an important factor in setting priorities. The overview of parameters used by different assessments that WGBIOP is developing, will contribute to this measure. Table 4.1.2.1 (Annex 3) presents a summary overview of different parameters which were listed in various reports of integrated ecosystem assessment (IEA) working groups and workshops. Selection of new and most relevant biological parameters for IEA based on defined prioritization criteria as an assessing tool, will be continued during the intersessional work and the next WGBIOP meeting in 2017. The selection process will also involve participation of IEA working group's advice considered as a necessary, valuable input. In addition, identification of databases ready to use for estimation of biological parameters will also be the task of intersessional work, with its final outcome presented during the 2017 meeting.

### **5.1.3 Deliverables for WGBIOP 2017**

WGBIOP will provide an overview of parameters used by different IEA assessments at the end of the first 3-year term with associated priorities in terms of operationality.

## 5.2 ToR b) Evaluate quality of biological parameters: Issues, quality indicators and guidelines

This ToR is designed to: 1) Evaluate issues put forward by the assessment WGs for upcoming benchmark species; 2) Formulate quality indicators, specifically focusing on statistical indicators; 3) Produce guidelines on how quality indicators can, and at which point, be inserted in the ICES benchmark flow.

### 5.2.1 Progress during WGBIOP 2016

In 2016 ToR B prepared various deliverables:

- Issue table
- Update the issue table from 2015 with replies from stock coordinators (Annex 6 in ICES, 2015).

After the 2015 meeting stock coordinators were contacted. Most of the stock coordinators replied that the WGBIOP information was very helpful. As a result our suggestions were taken into consideration (Annex 4 Table 1). However, not all stock coordinators replied (Annex 4 Table 1).

In 2016 issues put forward by the assessment WGs for upcoming benchmark stocks were collated (“top-down” approach) and the various WG’s reports screened for issues (“bottom-up” approach) (Annex 4 Table 2). As in 2015 some issue lists were again missing for some species (see Annex 4 Table 2), despite this issue being put to ACOM and the BSG by the WGBIOP chairs.

- Formulating quality indicators

The quality indicators defined last year were updated and a flow scheme suggested where and how these can be incorporated into the ICES benchmark process (Annex 4 Tables 3 & 4). This also includes the recommendations WGBIOP received for inclusion of the AgeErrorMatrix into assessments.

The benchmark steering group (BSG) developed a new benchmark process proposal that was presented in September 2016 at the Annual Science Conference in Riga, Latvia. This proposal is being further developed and the WGBIOP chair will present the quality indicator scheme of biological parameters at the next meeting of the BSG.

The quality indicator scheme of biological parameters should be considered at the Scoping meeting at an early stage of a benchmark process.

Inspired by the draft quality indicator table outlined during WGBIOP 2015, the table was developed further during WGBIOP 2016. The general approach applied for the modification of the draft quality indicator table was to cover the whole process of collection, analysis and use of biological data and enlarge the scope including also parameters other than age and maturity.

InterCatch usually provides only one international output dataset. The nationally raised biological data (e.g. numbers-at-age) uploaded to InterCatch are directly channelled into the InterCatch output used in the assessment. However, to really assess the role of selected national biological datasets on the assessment outcome (e.g. to assess different age interpretations of major TAC countries, national raising schemes), the data submitted to InterCatch would have to be raised in a more differentiated way. For instance, if an otolith exchange showed that there are major differences in age readings between two countries with a major TAC of a stock, alternative Inter-

Catch outputs based on raising the catch data with the biological information from each country separately would be required.

Modifications of InterCatch would be required to allow for commercial fisheries data raised with different, alternative biological data, for use in sensitivity runs. For a thorough quality control system of the data used by ICES in stock assessments, either as part of the routine annual stock assessments or benchmark processes, the possibility of producing InterCatch outputs where national landings data are raised with alternative biological datasets should be seriously considered (e.g. discard ratios, biological data). Currently, this is only possible for empty strata, i.e. strata without national discard or biological data.

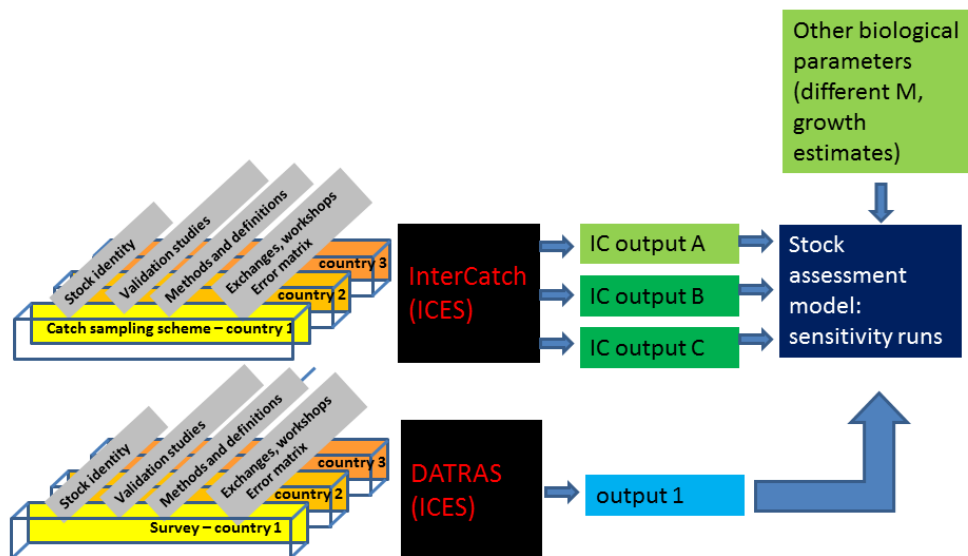

Figure 4.2.1.1 Draft schematic summary of the work steps that may be considered in a quality control scheme of biological data of a shared stock. Commercial catch sampling data from several countries enter ICES through InterCatch. IC output A: currently InterCatch can only produce 1 output where reported national biological data are inseparably connected to the national catch data; landings and discard data already raised nationally cannot be raised with biological data from another country. International survey data enter ICES through DATRAS; also only 1 output is produced.

- Case studies

During WGBIOP 2015, mackerel was identified as a first case study, and as a second case study, it was decided to identify a stock from the WGNSSK. Hence the stock coordinator of sole 7d was contacted, with the request to use this stock as the second case study. At WGBIOP 2016, the stock was confirmed as a case study.

Actions that were taken by WGBIOP for initiating the case studies:

#### Case study 1: NEA Mackerel

In preparation for the WGBIOP 2016 meeting, the stock coordinator was contacted for issues and questions with regards to NEA mackerel. The data compilation workshop will take place in November 2016, while the actual benchmark is scheduled for February 2017.

Issues concerning biological parameters were collated (Annex 4 Table 5) and available quality indicator information collected (Annex 4 Table 6). The stock coordinator

and assessor were contacted with the information and a request for comments and usefulness of this information for the benchmark and assessment.

#### **Case study 2: Sole 7d**

In preparation of WGBIOP 2016, the stock coordinator of sole 7d was contacted, to confirm this stock to be the second case study. The stock will be benchmarked in February 2017 and the data compilation workshop in preparation of the benchmark, is scheduled for 7-11 November 2016.

Correspondence with the stock coordinator has started to initiate the case study, with maturity as the biological parameter for which quality parameters could be formulated. Through correspondence with the stock coordinator, the issues regarding maturity were inventoried. (The commercial Belgian data Maturity: sole 7d; Quarter 1,2 and 4; Years: 2004–2015, are analysed and can be found in Annex 4.7). In preparation of the data compilation workshop and the benchmark, all available maturity data of the stock which could be used in the stock assessment, were also evaluated. The details of the evaluation are given in Annex 4.8.

It is a jackknife maturity ogive (i.e. 100% maturity-at-age 3). During the benchmark on sole 7d, all available information on maturity will be investigated and checked if something needs to be changed on the maturity input file for the assessment.

Now a 4-stage scale is used to determine maturity, however it is not always straightforward to determine the correct stage, according to the observers who determine the maturity. Therefore, to improve the quality of maturity information, regular workshops should be organized to make sure there is agreement across member states. An exchange of pictures of gonads across member states is also a possibility (cfr. Otolith exchange).

Second, determination of maturity stages is more difficult for males. Histological examination should be the preferred method, or there should be at least an indication on how the maturity is determined: histologically vs. macroscopically – to get an idea of the quality of the data, especially in males.

However, no quality indicator has been used on the data of maturity.

#### **5.2.2 Work plan for WGBIOP 2016–2017**

WGBIOP will work towards an achievement of the following points prior to the WGBIOP 2017 meeting:

- Intersessional stock coordinators for benchmark species will be contacted with issues identified.
- An AgeErrorMatrix for the case study on Sole 7d will be created and together with the stock coordinator it will be investigated how to incorporate this in the assessment.
- Statistical input sought for the implementation of the quality indicators into the assessment.
- Present the quality indicator scheme of biological parameters at the next meeting of the BSG by the WGBIOP chairs.

### 5.2.3 Deliverables for WGBIOP 2017

Using the information and expertise obtained over the past two years, generic guidelines for the evaluation of the quality of biological parameters will be created. However, this will be a continuous development as our knowledge in these fields will increase with time.

Milestones for WGBIOP under ToR b:

- Evaluation of issues put forward by assessment WGs for benchmark species in 2018
- Consolidate quality indicators for “classic” biological parameters
- Evaluate case studies
- Produce generic guidelines

### 5.3 ToR c) Plan studies, workshops and exchange schemes and other intersessional work related to interpretation and quality assurance of data on stock-related bio-logical variables and review their outcomes.

This ToR is a generic ToR for the group and will be part of the WGBIOP remit much along the lines of what was done in PGCCDBS and WKNARC previously. The ToR covers the following points:

- 1) Respond to the recommendations received from other expert groups
- 2) Draft resolutions for workshops and exchanges to be approved for 2017 and onwards
- 3) Report and review results from WGs and Exchanges occurred the past and current year
- 4) Annually update a series of files: The guidelines for age-and maturity calibration workshops; the interactive table of workshops and exchanges; the age-reader and maturity-stager contact lists; and the database of material, techniques and preparation methods by species and areas to fish ageing.

#### 5.3.1 Progress during WGBIOP 2016

All recommendations were discussed and appropriate action was taken, including filling in the ‘Final recipient action’ column in the Recommendation database. WGBIOP received a total number of 29 recommendations that were handled by the group, divided into the subgroups.

The proper channel for inducing an exchange/workshop is for WGBIOP to report a recommendation in the annual report, and this request is decided upon by WGDATA and ACOM/SCICOM. Exchanges and workshops are therefore usually planned more than a year before they are supposed to take place. WGBIOP reviews the suggestions for exchanges and workshops in relation to the needs of the data-end-users. If a stock suggested was not assessed applying age-based data, the relevant stock-assessors and stock-coordinators were approached in order to clarify the actual need for a calibration of age-estimation of the particular stock. In cases where there was pronounced a wish to gain knowledge of age-reading methods/validate age-estimation methods, WGBIOP drafted resolutions for short scoping workshops with main ToRs for outlining the options for such validation work, whether it is feasible to pursue an age-based structure of data and how to proceed to gain the necessary scientific background.



In order to be able to react to sudden problems, it will be necessary to have a direct communication between the stock coordinator and WGBIOP, deciding upon an action. It is important that chairs of previous and suggested workshops/exchanges are included in this communication, as there might be some planning already going on, which can be useful.

Reports from past exchanges and workshops were reviewed and the results were discussed. Recommendations from the outcomes of these reports were evaluated (Annex 5). Draft resolutions for suggested Workshops/exchanges by the Recommendation system in ICES was made if endorsed by WGBIOP. Annex 6 lists those planned exchanges and workshops.

During WGBIOP an update was made on all the workshops and exchanges occurred, ongoing and planned, relating both ageing and maturity. The most updated version can be found either in the Data Quality Assurance Repository as well as at the Age Readers Forum (ARF).

The national maturity stagers contact list was updated. Among 57 National countries stagers contacted, only 9 didn't send any answer. The list can be found at WGBIOP Data Quality Assurance Repository or at the Maturity Staging Forum. The national age-readers contact list was also updated, partly before and partly during the WGBIOP 2016 meeting. By the end of the meeting there were still 1 country (marked yellow in the age-readers contact table) that had not responded to the requests of updating the age readers contact information. The reason for this was assumed to be in most cases the overlap of the meeting and fish-surveys.

Most of the National laboratories did not make any change for their material, techniques and preparation methods by species and areas so their techniques are assumed to be up-to-date. Several of them made some changes, for example, in preparation methods (changing the otolith preparation from whole to break and burn or sectioning and staining for a specific species). Only 3 laboratories haven't replied and the WGBIOP 2016 was not in the position to judge if they needed to make any change to their material, techniques and preparation methods by species and areas. Lastly, there is some new information added from the National laboratories about their techniques that at first were not on the table.

The possibility for task sharing between National laboratories were discussed with off-set in feedback from the RCGs in 2016. WGBIOP endorse task-sharing and suggest that collaborative studies to standardize age reading and the development of cooperation between national institutes on a regular basis would be an essential tool for improvement of age data quality. The mechanism for task sharing is established through bilateral agreements between National laboratories and WGBIOP will mainly act as a facilitating organ, where new bilateral agreements can be discussed between National age-reader coordinators and then consolidated in the respective laboratories by the appropriate decision-makers.

### **5.3.2 Work plan for WGBIOP 2016–2017**

WGBIOP will approach PGDATA for a discussion on how to evaluate suggested workshops/exchanges for stocks where the need for age-based data may not be urgent in terms of cost–benefit considerations.

WGBIOP will work closely with the ICES secretariat in order to change the format of the table of past workshops and exchanges in Annex 7 to make it more user friendly. Among these, focus will be on:

- 1) Species in alphabetical order
- 2) Cells that need to be merged or unmerged
- 3) Divide the column name in two, one with the English name and the one with the area (division etc. etc.)
- 4) Standardize the text for exchanges and Workshop (now it is written Ex, exchange, workshop, wk ) as
  - a. Exchange. Coordinator's name and country
  - b. Acronym (WK...) Workshop on ....
- 5) Update the links

In addition, a check as to whether all stocks are included will be made as well as the addition of an extra column with the name of the Assessment WG where each species is included.

### **5.3.3 Deliverables for WGBIOP 2017**

WGBIOP will aim for having the annual updates of the files done prior to the 2017 meeting in order to facilitate a smooth process. Likewise will the subgroup present an overview of recommendations and possible actions at the beginning of the 2017 meeting allowing for inputs in the initial phase of handling the recommendations?

The initiated detailed table of possible task-sharing (Annex 12) will be updated where appropriate and reported along with a full list of already established bilateral agreements by species and area.

### **5.4 ToRs d and e) Address requests for technical and statistical recommendations/advice related to biological parameters and indicators and continue development of tools for the exchanges and workshops**

Again this year WGBIOP decided to merge two ToRs, this time the more technical aspects of WGBIOP. The ToR will handle any technical recommendation put forward to the group and for 2016 these exclusively concerned the shape and need for upgrade of WebGr. Thus WGBIOP decided to merge the ToRs d and e this year.

The main achievement of the subgroup handling ToRs d & e was the future tool for calibration exercises. The WebGr was decided to be substituted by 'SmartFish', a tool which possess all desired features of WebGr, but already thoroughly tested and operational. A dialogue with the ICES DC was initiated and a steering group formed ensuring a continued process for implementation. Additionally a discussion of recommendation system had been initiated with the ICES secretariat to facilitate an operational recommendation-system categorizing the nature of the recommendations which in turn will allow operational advice from the recipients of the recommendation.

#### **5.4.1 Progress during WGBIOP 2016**

In 2015 it was decided that WGBIOP would develop a template for categorizing the nature of recommendations to facilitate an operational recommendation-system. It was suggested that a recommendation template should be developed to clarify the structure of recommendations and the tasks of each participant in the recommendation system. The need to standardize the approach by making recommendations to WGBIOP was identified so that 1) the group understands clearly, what was intended

and 2) the correct person(s) are identified in order to take the recommendation forward.

In 2016, other issues were also identified: a) chairs are often not aware of the recommendation table that they should fill in, b) the recipient does not get any feedback if the answer to a recommendation meets the expectations. Also, to avoid the possibility that chairs would have to fill in two templates (the new one and the ICES actual template), a new approach was investigated, and the previous version of the template (2015) was further developed, following the principles shown in a flowchart (Figure 4.4.1.1) and integrated into the already existing fields of the ICES database.

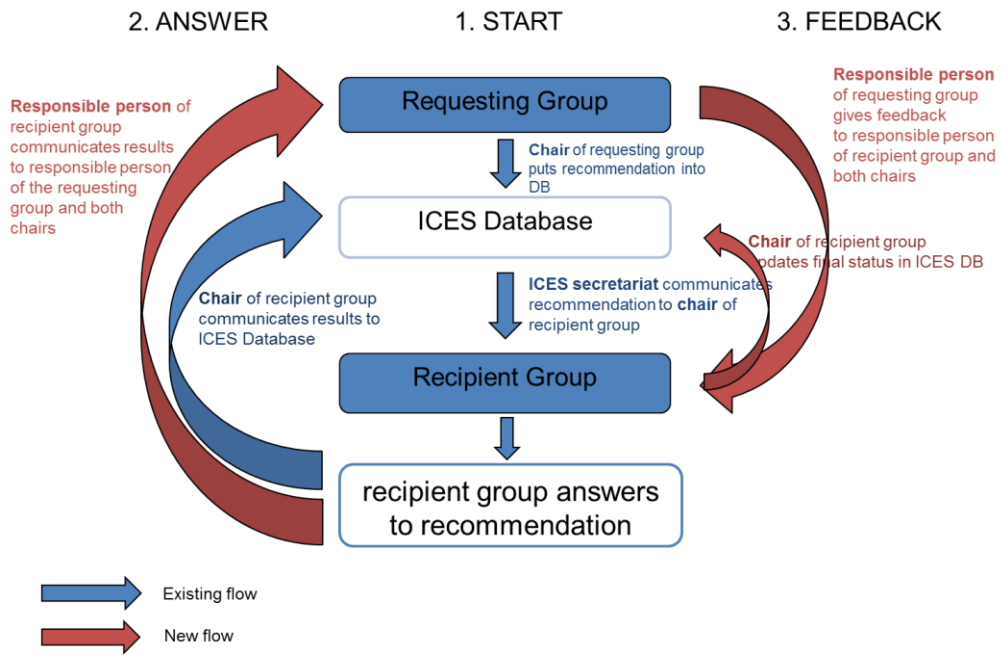

Figure 4.4.1.1 Flowchart of the proceeding of the recommendations.

Column 1 (start): The chair of the requesting group puts a recommendation into the ICES database for recommendations. The ICES secretariat communicates the recommendation to the chair of the recipient group, who then distributes these to the “responsible person” within the recipient group.

Column 2 (answer): When an answer is formulated by this responsible person, he/she communicates the answer to both chairs (of the requesting group and the recipient group) and the person that is in charge of this recommendation of the requesting group. The chair of the recipient group can then update the ICES DB. The direct communication (new flow) between the “responsible persons” will help to establish clear communication so that the requesting group knows that an answer was formulated.

Column 3 (feedback): to ensure that the answer meets the expectations of the requesting group, a new flow for feedback is foreseen in the flowchart. Therefore, the responsible person of the requesting group gives feedback to the responsible person of the recipient group and both chairs. Finally, the chair of the recipient group updates the “final status” field in the ICES database.

The new adapted template includes the fields already in the actual ICES recommendation database, extended with new drop-down options for more precision and new

fields for making the proposed flow possible (Figure 4.4.1.2). A total of 15 fields were applied. A short guide on filling the recommendations is suggested for the EG chairs (Annex 8a).

For this approach, the recommendation database has 3 different areas that need to be filled in by the different people involved in the recommendation. Fields 1 to 9 should be filled in by the chair of the requesting group (see guidelines in Annex 8a); fields 10 and 11 should be filled by the ICES secretariat and fields 12 to 15 should be filled in by the recipient group.

Expert Group (EG; field 1) and year (field 2) are already in the ICES website recommendation database. Then, a third field should be added to identify the responsible person that requests the recommendation and may not be the chair of the Working Group. The recommendation category field (field 4) is already in the ICES database but new possibilities should be included in the drop-down menu e.g. Biological parameter (age, maturity, others); abiotic parameter (temperature, nutrient concentration, others); Software; others. Next fields identify the species and stock (field 5 and field 6) also with drop-down menus. These drop-down menus consider the possibility of multiple selections such as “flatfish” and “all Baltic” as well as individual selections such as “cod” and “8a”. An overview of the new drop-down possibilities is given in Annex 10b. After that, the chair of the requesting group should include background information on the problem in a free text box (field 7). This information should be short and concise and should put the recipient group in the context of the problem. The next boxes (field 8 and field 9) are already in the existing ICES database. In field 8 the requesting person should describe the particular issue that needs to be addressed. Field 9 is to select the relevant group from the drop-down menu to send the recommendation to (i.e. WGBIOP). This ends the input from requesting workshop chairs. Version history and Status (fields 10 and 11) are filled in by the ICES secretariat and already are in the recommendation database.

Final recipient action, person responsible, date and final status (fields 12 to 15) are filled in by the recipient group and the final status list should include the possibilities accepted, rejected, communicated and feedback received.

Guidance to fill in all the options are explained in the User’s guide that should be available on the same webpage.

Fields 10-11: to be filled by the ICES secretariat

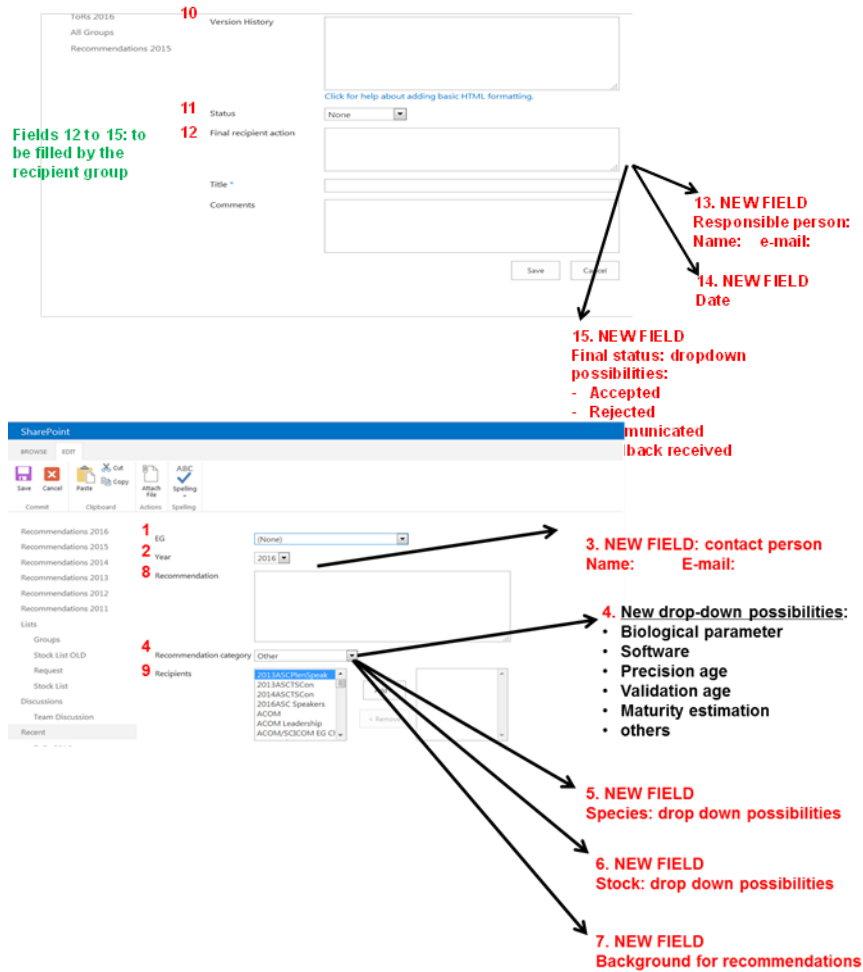

Figure 4.4.1.2 Integration of the template from 2015 into the ICES template.

### 5.4.2 Calibration tool (ToR e)

WebGR is a set of Open Source web services developed within an EU tender project in 2008 to support studies of fish growth (age) and reproduction (maturity). This tool has assisted fisheries scientists in the organization of calibration workshops for classification of biological structures and has provided a means to analyse the results of such exercises thus supporting the provision of quality assured data. Additionally, the use of such a tool is not necessarily limited to age and maturity studies. In principle, WebGR can be applied regionally where scientists and technicians need to discuss the interpretation of a protocol, for the validation of biological parameters.

Since 2010 more than 90 workshops and exchanges have used WebGR with variable success. In order to secure a continuation of the high standard of quality which is required, it is important to have a tool which is functional and updated so that the end-user's needs are continuously met. Much progress has been made in identifying the steps needed to further develop the tool to make it more operational and to fulfil the requirements of the new DCF in terms of data quality. This can in part be done by a regional agreement of age reading protocols and maturity scales, ultimately improving fisheries management advice. A comprehensive list of improvements has

been compiled, however WebGR as a tool has not been further developed neither improved since 2010.

Currently, AZTI is hosting the service at <http://webgr.azti.es>, with no cost to the users. Major security flaws were identified by AZTI in 2015 which resulted in a rescue plan being set up to begin in 2016, and implemented in March 2016, in order to avoid the expected total shutdown of WebGR. This has ensured a continued use of a valuable tool; however no new features were added and further development was not done. A detailed description of the rescue plan can be found in the WGBIOP report 2015. In addition, WGBIOP 2015 outlined a proposal for the upgrade of WebGR (based on the above mentioned list) and concluded that getting the service up to an acceptable level will be a costly and lengthy process.

At WGBIOP 2016 a programme called Otolith Manager 1.0 – Smartlab 2.0 (part of a set of different tools called SmartFish, developed within ILVO,) which has been developed by ILVO Belgium, was presented to the group. SmartLab is a tool which has many similar features to WebGR but in addition has many of the features which are required for WebGR to function to the standard which is desired. This programme is currently only used locally at the Belgian institute, and further development would be needed in order to make it function at an international level. The operating language and development platform on which it is built are compatible with those used in ICES.

During WGBIOP 2016 a Skype meeting was held with some of the group members, ICES Secretary (Neil Holdsworth) and ILVO IT (Wim Allegaert). The possibility of further develop SmartLab and/or WebGR to a standard where ICES could host such a tool on their server were discussed. ICES's reservations about taking over WebGR are related to the coding language, development platform and security issues which still exist. Since SmartLab is compatible with programs used at ICES, regarding these issues such concerns are not envisioned to be an obstacle and ICES could see the advantages of hosting SmartLab. Agreement was made to progress further with the steps needed to get the programme SmartLab up and running on the ICES server and it was suggested SmartLab be adopted as an alternative to WebGR. A summary of the meeting can be found in Annex 9.

#### 5.4.3 Workplan for WGBIOP 2016–2017

A plan for implementation of the integrated database was discussed. In 2016, the development of the integrated database (template 2015 and the already existing recommendation) should be discussed between the chair of WGBIOP and the ICES secretariat. Depending on the opinion of ICES, a test database could be built. Then, in 2017 feedback will be received and the database and user's guidelines can potentially be revised. If such a database was built, clear communication between ICES and all chairs of workshops/working groups/study groups would be necessary. Then, full implementation of the database could be possible. A system of automatic e-mails sent to a chair would be useful e.g. when a new recommendation is made for the respective working group.

For the calibration tool, the following work plan was decided:

- 29th November there will be a meeting held next to the SGRDB (Steering Group for the Regional Database) on how the development of SmartLab has been up to now and how to progress. The meeting will be attended by DTU-Aqua, ILVO and ICES Da-

ta Centre and ICES software developers. One of the objectives of this meeting will be to discuss the time and resources needed for the development.

- An application made for funding through the RCM's
- A consortium will be made based on the required expertise available in various institutes.
- February 1st 2017: ILVO implements SmartLab version 2.0, followed by a WebEX and demo during February 2017 with ICES and a steering group. From this, a plan for further needs, timeline, and costs will be laid out based on the compiled list of priority issues.
- The development of SmartLab version 3.0 to be presented at WGBIOP 2017.

During the discussion of the workplan at WGBIOP, the following institutes – ILVO, DTU-Aqua, IMARES, CEFAS, IMR, IFREMER, SLU-Aqua, Marine Lab Scotland, and HCMR – expressed an interest in providing input towards the development of the new calibration tool.

#### **5.4.4 Deliverables for WGBIOP 2017**

A work plan with the description of what needs to be developed for SmartLab, the timeline, the identification and allocation of skills for the realisation of the work plan.

The development of SmartLab version 3.0 to be presented at WGBIOP 2017.

Once ready the software to be tested in a small exchange planned by WGBIOP in late 2017 or early 2018.

The comprehensive list of prioritised and grouped improvements can be found in Annex 10 which will be updated once a time line and budget for each task are available. Notes from the Skype meeting held are also here.

## **6 WGBIOP in context of Liaison Meeting and Regional Coordination Meetings, ICES and GFCM**

---

WGBIOP is keen on interfacing with the RCMs and the LM to ensure an information flow between these groups and WGBIOP, thus recommendations and views from these groups were discussed during the meeting. The main concerns from these regional groups were the status of WebGr and the approach to stocks not currently subjected to age-based assessments and the collection/calibration of biological parameters for these. Both concerns were key elements of the ToRs of WGBIOP and were treated thoroughly in these ToRs (WebGr in ToR d&e; non-age based stocks in ToR c).



## 7 Revisions to the work plan and justification

---

During WGBIOP it was decided to merge ToR d) and e) due to their technical orientation. Thus the ToRs for WGBIOP in 2017 are the following:

- 1) Identify and assess new biological parameters as input to integrated ecosystem assessments and continue the development of methods and guidelines for best practice in the analysis of biological samples providing such parameters meeting end-user needs
- 2) Evaluation of quality of biological parameters: issues, quality indicators and guidelines
- 3) Plan studies, workshops and exchange schemes or other intersessional work related to interpretation and quality assurance of data on stock-related biological variables and review their outcomes
- 4) Outline the objectives, methods and potential experts to join in species-specific validation studies on selected species (to be communicated during first half of 2017)
- 5) Address requests for technical and statistical recommendations/advice related to biological parameters and indicators
- 6) Update and further develop tools for the exchanges and workshops (e.g. SmartLab/WebGr, other statistical tools, age readers/maturity stagers forum)

The work plan for the last term of the first 3-year term of WGBIOP will include an identification of future needs in line with the remits of WGBIOP, further development of the initiated processes to operationalize quality assessed biological parameters for IEAs, assistance to the benchmark process in ICES and create a 3-year work plan for the term 2018–2021.

Year 1	Consolidate WGBIOP workplan (ToR 1). Initiate the collation of a) information related to potential new biological parameters; b) Benchmark Issue Lists; c) Guidelines. ToR 5-7 are generic ToRs and will be dealt with on a yearly basis in WGBIOP
YEAR 2	<b>IMPLEMENT THE QUALITY INDICATOR FOR CURRENT BENCHMARKS; DEVELOP METHODS/GUIDELINES FOR BEST PRACTICE FOR THE COMPUTATION OF THE NEW REQUIRED BIOLOGICAL PARAMETERS; FURTHER DEVELOP THE GUIDELINES IN TOR B.</b>
Year 3	Review the current status of issues, achievements and developments that falls under the remit of WGBIOP, identify future needs in line with the ICES objectives and Science Plan and the wider marine environmental monitoring and management within Europe and propose a future/alternative work plan

## **8 Next meeting**

---

WGBIOP 2017 will meeting in Cagliari, Sardinia (Italy) from 2–6 October and will be chaired by Lotte Worsøe Clausen, Francesca Vitale and Pedro Torres.

## Annex 1: List of participants

MEMBER	INSTITUTE/DEPARTMENT NAME	E-MAIL	PHONE
Ana Maria Costa	Portuguese Institute for the Sea and the Atmosphere (IPMA)	amcosta@ipma.pt	
Andreia Silva	Portuguese Institute for the Sea and the Atmosphere (IPMA)	avsilva@ipma.pt	+351
Christoph Stransky	Institute of Sea Fisheries	christoph.stransky@thueningen.de	+49 4038905228
Cindy van Damme	Wageningen University & Research	cindy.vandamme@wur.nl	
Dace Zilniece	Institute of Food Safety Animal Health and Environment (BIOR)	dace.zilniece@bior.gov.lv	7610766
David Maxwell	Lowestoft Laboratory	david.maxwell@cefas.co.uk	+44 1502 524 328
Els Torreele	Institute for Agricultural and Fisheries Research (ILVO)	els.torreele@ilvo.vlaanderen.be	+32 59569833
Eugenia Lefkaditou	Institute of Marine Biological Resources	teuthis@ath.hcmr.gr	+30 2109856705
Francesca Vitale	Institute of Marine Research	francesca.vitale@slu.se	+46 10 478 4052
Gróa Pétursdóttir	Marine Research Institute	groa@hafro.is	+354 5752000
Iñaki Quincoces (by correspondance)	AZTI Sukarrieta	iquincoces@suk.azti.es	+34 94 602 94 00
Jane Godiksen	Institute of Marine Research	jane.godiksen@imr.no	+47
Jari Raitaniemi	Natural Resources Institute Finland - Turku	jari.raitaniemi@luke.fi	+358 295 327 685
Jerome Quinquis	Ifremer	Jerome.Quinquis@ifremer.fr	+33
Jukka Pönni	Natural resources and bioproduction	jukka.ponni@luke.fi	+358 29 532 7894
Julie Coad Davies	DTU Aqua - National Institute of Aquatic Resources	joco@aqua.dtu.dk	+45
Kelig Mahe	Boulogne-sur-Mer Centre	Kelig.Mahe@ifremer.fr	+33 321 995602
Krzysztof Radtke	National Marine Fisheries Research Institute	radtke@mir.gdynia.pl	+48 587356223
Lotte Worsøe Clausen	Section for Fisheries Advice	law@aqua.dtu.dk	+45 21362804
Maria Cristina		follesac@unica.it	+39 0706758014

---

Follesa			
María Sainza	Centro Oceanográfico de Vigo	maria.sainza@vi.ieo.es	
Pedro Torres	Centro Oceanográfico de Málaga	pedro.torres@ma.ieo.es	
Pierluigi Carbonara	Tecnologia & Ricerca	carbonara@coispa.it	+39 080 5433596
Tiit Raid	Estonian Marine Institute	Tiit.Raid@ut.ee	+372 58339340
Uwe Krumme	Baltic Sea Fisheries	uwe.krumme@thuenen.de	+49 381 8116-148

---

## Annex 2: Recommendations from WGBIOP

RECOMMENDATION	ADRESSED TO
Steering group for the development of a web-based tool for calibrations and exchanges under the auspices of ICES must be formed. WGBIOP has outlined a roadmap and several Member States have indicated interest in membership. The steering group needed to coordinate development in collaboration with ICES and will be consolidated in November 2016. WGBIOP would like endorsement at the ACOM/SCICOM November meeting. Background in ToR d&e; contact persons: Julie Davies (DTU Aqua)/Els Torreele (ILVO)	ACOM/SCICOM leadership
WGBIOP maintains an overview of past calibration workshops, exchanges and other relevant groups for the quality assurance of biological parameters. This overview is in high need of an updated format and user-interface. WGBIOP recommends this to be done in collaboration between the ICES secretariate and the WGBIOP chair. Contact person: Lotte Worsøe Clausen (DTU Aqua)	ICES secretariate in coop. with WGBIOP chair
WGBIOP recommends progress towards an inclusion of an AgeErrorMatrix in assessment models while considering separability in time-series with changes in uncertainty around age-estimations. Background in ToR b); contact person: Cindy van Damme (Wageningen Marine Research)	WGMG
WGBIOP recommends a close link with the BSG and advocate for having specific quantitative/statistical expertise to join the WGBIOP intersession tasks for ToRs a and b. Contact persons: Lotte Worsøe Clausen (DTU Aqua) and Cindy van Damme (Wageningen Marine Research)	BSG, National delegates
WGBIOP recommends the development of a more user-friendly recommendation database interface with off-set in the work performed under ToR d&e in 2016. This work should be done as a collaboration between the ICES secretariate and WGBIOP chairs. Contact person: Lotte Worsøe Clausen (DTU Aqua)	ICES secretariate in coop. with WGBIOP chair

### **Annex 3: Strengthening links to groups using biological parameters**

#### **Linking to the Working Group on Multispecies Assessment (WGSAM)**

WGBIOP contacted the chairs of the WGSAM (Sarah Gaichas & Daniel Howell), explaining the scope of WGBIOP and asking for suggestions for new or existing biological parameters that WGSAM would consider a priority to collect, collate or improve to inform multispecies assessment.

A set of research questions for multispecies models was received (Robert Thorpe, *pers. comm.* rather than a WGSAM position).

#### **Some multispecies modelling research questions related to biological parameters:**

- a) Estimates of Life history parameters, Linf, Lmat, VBG k, etc. & relationships between length and weight, length and age, and length and mortality (survivorship curves).
- b) A meta-analysis of the relationships between the various life history parameters. Does the data support specific relationships between them, e.g. Linf and M at length, Linf and k etc. There are theoretical relations between these, but what has been measured?
- c) Are there any relationships in the data between recruitment variability and the life history parameters of fish stocks?
- d) Are there any attributes of fish life histories that could be used to infer possible diet matrices in the absence of stomach data?
- e) One of the key uncertainties in the multispecies modelling concerns how “interactive” the system is. To what extent would a set of single species models be an adequate representation of the fish community? We might be able to infer this if we could get mortality at length estimates for a number of stocks at the same time as inferred from data and not model products.
- f) If we were to make an individual-based model for say the North Sea, is there any information on the rules individual fish may follow to migrate (e.g. towards food, away from rival fish) or when partitioning energy. For example, if a fish has more than enough energy to survive, how is the rest partitioned between growth, recruitment, and reserves?

These questions provide a rationale for calculating biological parameters, which then defines the biological data that WGBIOP could be investigating, i.e. through a process starting with a Research question leading to a suite of Parameters for which WGBIOP can define which Data that are required. A first attempt at defining these links is below.

#### **Required parameters and data**

PARAMETER	DATA	RELATED TO QUESTION
Linf	Length & Age	a), b), c), d)
Lmat	Length & Maturity	a), b), c), d)
Von Bertalanffy Growth, k	Length & Age	a), b), c), d)
Mortality (Survivorship curves)	Numbers-at-age	a), b), c), d)

Mortality at length	Numbers at length	e)
Recruitment	Numbers at age or length	d)
Diet matrices	Stomach samples	d)
Diet matrices	Length, gape size	d)
Individual behaviour	? Tagging	f)
Energy partitioning	? Body condition	f)

Several of the research questions relate to data that is regularly collected, so the task is ensuring it is available at the resolution and quality required. The questions also highlight that it is important for the data on different parameters to be collected in a consistent and integrated manner so they can be combined for analysis.

### **Stomach data**

#### *fishPi project*

The main outcome of Workpackage 3.2 of the fishPi project (REF) is a regional sampling plan for the collection of stomach data. A questionnaire has been sent to national labs to check the current status of stomach data collection. The analysis of the responses showed that some countries already collect diet information, but it is not a general practice and in the majority of the cases, the sampling is not coordinated at a regional scale and the information obtained is not available for the scientific community. There is also considerable historic data, mostly from pelagic and demersal commercial species, that could be integrated in common regional datasets to inform existing models and understanding long term community interactions within each ecosystem.

The most effective sampling scheme is highly dependent on specific user needs and the species considered. These should be agreed between the countries' scientific community based on general principles provided in the project report. Many of the sampling guidelines suggested highly benefit from an opportunistic sampling in internationally coordinated surveys inside the DCF and add on fish diet sampling to minimize direct costs, providing comprehensive and comparable diet description on a regional basis.

Synergies between a stomach collection protocol and the monitoring of human pressures and affects under the Marine Strategy Framework Directive (MSFD, Descriptors D1, D4 and D10), and surveillance of marine biotoxins should be considered. This valuable additional information could be analysed at very little additional cost but relevant in many areas of scientific knowledge and with significant added value for the fishing industry, economies and human health.

Common databases (RDB, DATRAS) should be the preferred selection to upload these data. A lot of work has been done during recent years to standardize format and protocols to upload these data into these databases.

The project report (Annex 16) also lists existing and potential end-users of stomach data, provides an overview of existing datasets, sampling coverage and data gaps, a review of data collection methodologies and data sources, guidelines for a protocol of stomach data collection, as well as priority stocks.

#### *Mediterranean & Black Sea project*

One of the main objectives of the new CFP is the implementation of the ecosystem-based approach to fisheries management so as to ensure that negative affects of fishing activities on the marine ecosystem are minimised. In this context, the objectives of the new DCF must be integrated with other policies such as the MSFD and the Habitats Directive. Ecosystem aspects such as biodiversity, ecosystem health and functioning should be considered; therefore, new data types related to biodiversity, foodwebs, and environmental impact would be required. Within this context, the general objective of the Work Package 3 (WP3) of the MARE/2014/19 project is thus to design a Regional Sampling Programme of Data Collection on Fisheries Impacts on the Ecosystem (RSP-DCFIE) for 2016 aimed at collecting data not included in the current EU Multiannual Programme.

This Deliverable is the result of different and sequential steps, following a complementary approach:

- review of bibliography on ecosystem indicators;
- selection of the most adequate ecosystem indicators for the Mediterranean and Black Sea;
- proposal of additional ecosystem indicators.

A proposal for the computation of additional ecosystem indicators is included in the deliverable document. This proposal doesn't fall under new data requirements for Member States, but it can be an integrative tool to better describe the ecosystem effects due to fishing and also to fulfil the Marine Strategy Framework Directive objectives.

The following ecosystem indicators are suggested:

- Typical Length (TyL) (geometric mean length of fish, weighted by body mass);
- Mean Trophic Level (i.e. from commercial and scientific surveys data);
- Kempton's Q75 index – Biomass diversity index;
- N90 index.

### **Baltic cod stomach sampling**

Cod stomachs sampling during Baltic International Trawl Surveys (BITS) is an example of currently ongoing routine procedure implemented by all the Baltic Sea countries. This task of BITS surveys is realized on the request of WGSAM. WG on Baltic International Fish Surveys (WGBIFS) prepared a manual and database format on cod stomachs sampling during BITS surveys which is in line with the accomplished MARE project devoted to that sampling (ICES 2016). In November-December 2015 and in February-March 2016 most of the countries collected the samples, however the content of stomachs was examined by three countries only. In April 2016, the WGBIFS agreed to stop further international coordination of Baltic cod stomach sampling as the Group has not received any formal request to coordinate the programme as well as has not obtained any plan for future stomach samples usage and working up. The Group agreed also that these data collection depends on the individual decision and responsibility of a given country. Thus, individual country can go on with the cod stomachs sampling and analyses, based on their experiences, staff, and financial possibilities. The decision was also taken due to limited number of cod feeding experts, relatively high costs of stomachs working up, lack of interest from WGSAM and not fully developed ICES database for that sort of data (ICES 2016).



ICES 2016. Second Interim Report of the Baltic International Fish Survey Working Group (WGBIFS), 30 March-3 April 2016, Rostock, Germany. ICES CM 2016/SSGIEOM: 07. 591 pp.

**Table 3.1 List of parameters indicated in the reports of integrated ecosystem assessment (IEA) working groups and workshops.**

Working Group Name	Parameters or group of parameters	Ecoregion
Working Group on Integrated Assessments of the North Sea (WGINOSE)	annual mean chlorophyll	Greater North Sea
	annual mean nitrate	Greater North Sea
	annual mean silicate	Greater North Sea
	annual mean phosphorus	Greater North Sea
	annual mean temperature	Greater North Sea
	annual mean salinity	Greater North Sea
	annual mean ammonium	Greater North Sea
	fish species abundancies (cpue)	Greater North Sea
Working Group on Integrated Assessments of the Baltic Sea (WGIAB)	foodweb	Baltic Sea
	abundance-based	Baltic Sea
	phytoplankton maximum dimension	Baltic Sea
	phytoplankton biovolume	Baltic Sea
	phytoplankton area to volume ratio	Baltic Sea
	phytoplankton basic shapes	Baltic Sea
	phytoplankton chain building	Baltic Sea
	phytoplankton solitary	Baltic Sea
	phytoplankton resting stages	Baltic Sea
	phytoplankton heterotrophic	Baltic Sea
	phytoplankton silica	Baltic Sea
	phytoplankton bloom forming	Baltic Sea
	phytoplankton motility	Baltic Sea
	zooplankton body weight	Baltic Sea
	zooplankton feeding type	Baltic Sea
	zooplankton mobility	Baltic Sea
	size-based (fish) feeding type	Baltic Sea
	size-based (fish) mean length	Baltic Sea
	size-based (fish) L50	Baltic Sea
	size-based (fish) A50	Baltic Sea
size-based (fish) fecundity	Baltic Sea	
zoobenthos maximum size	Baltic Sea	
zoobenthos longevity	Baltic Sea	
zoobenthos reproductive frequency	Baltic Sea	
Working Group on Integrated Assessments of	nutrient concentrations: nitrate	Norwegian Sea
	nutrient concentrations: silicate	Norwegian Sea

the Norwegian Sea (WGINOR)	nutrient concentrations: phosphate	Norwegian Sea
	nutrient concentrations: chlorophyl concentrations	Norwegian Sea
	zooplankton biomass	Norwegian Sea
	pH of seawater	Norwegian Sea
	fish species growth-rate	Norwegian Sea
	fish species biomass	Norwegian Sea
	abundance of marine mammals	Norwegian Sea
	abundance of seabirds	Norwegian Sea
	fishing mortality as human pressure	Norwegian Sea
	feeding and diet composition of fish	Norwegian Sea
Working Group on the Integrated Assessments of the Barents Sea (WGIBAR)	salinity	Barent Sea
	ice coverage	Barent Sea
	North Atlantic Oscillation index	Barent Sea
	zooplankton biomass	Barent Sea
	jellyfish biomass	Barent Sea
	benthos biomass	Barent Sea
	shrimp abundance	Barent Sea
	fish species biomass	Barent Sea
	abundance of marine mammals	Barent Sea
	fishing mortality	Barent Sea
	feeding conditions	Barent Sea
	Working Group on Comparative Analyses between European Atlantic and Mediterranean Marine Ecosystems to Move Towards an Ecosystem- based Approach to Fisheries (WGCOMEDA)	population
total mortality		Atlantic and the Mediterranean
Working Group on the Ecosystem Effects of Fishing Activities (WGEKO)	Large Fish Indicator	Celtic and North Sea
Working Group on Multispecies Assessment Methods (WGSAM)	ecosystem	North Sea, Baltic Sea, Eastern Channel and Barents and Norwegian Seas
	fish biomass	North Sea, Baltic Sea, Eastern Channel and Barents and Norwegian Seas
	fishing mortality	North Sea, Baltic Sea, Eastern Channel and Barents and

		Norwegian Seas
	biodiversity: breeding success/failure of marine birds	North Sea, Baltic Sea, Eastern Channel and Barents and Norwegian Seas
	biodiversity: changes in plankton functional types (life form) index ratio	North Sea, Baltic Sea, Eastern Channel and Barents and Norwegian Seas
	biodiversity: plankton biomass and/or abundance	North Sea, Baltic Sea, Eastern Channel and Barents and Norwegian Seas
	biodiversity: population abundance/biomass of a suite of selected species	North Sea, Baltic Sea, Eastern Channel and Barents and Norwegian Seas
	biodiversity: Mean Maximum Length (MML) of demersal fish and elasmobranchs	North Sea, Baltic Sea, Eastern Channel and Barents and Norwegian Seas
	foodweb: reproductive success of marine birds in relation to food availability	North Sea, Baltic Sea, Eastern Channel and Barents and Norwegian Seas
	foodweb: changes in the average trophic level of marine predators (cf MTI)	North Sea, Baltic Sea, Eastern Channel and Barents and Norwegian Seas
	foodweb: change in plankton functional types (life form) index ratio	North Sea, Baltic Sea, Eastern Channel and Barents and Norwegian Seas
	foodweb: biomass and abundance of dietary functional groups	North Sea, Baltic Sea, Eastern Channel and Barents and Norwegian Seas
	foodweb: changes in the average faunal biomass per trophic level (Biomass Trophic Spectrum)	North Sea, Baltic Sea, Eastern Channel and Barents and Norwegian Seas
	foodweb: Large Fish Indicator (LFI)	North Sea, Baltic Sea, Eastern Channel and Barents and Norwegian Seas
	foodweb: EcoQO for proportion of large fish	North Sea, Baltic Sea, Eastern Channel and Barents and Norwegian Seas
	foodweb: size composition of fish communities	North Sea, Baltic Sea, Eastern Channel and Barents and Norwegian Seas
	community: mean length (ML)	North Sea, Baltic Sea, Eastern Channel and Barents and Norwegian Seas
	community: large fish indicator (LFI)	North Sea, Baltic Sea, Eastern Channel and Barents and Norwegian Seas
	community: size spectrum slope (SSS)	North Sea, Baltic Sea, Eastern Channel and Barents and Norwegian Seas
	community: mean maximum weight by biomass	North Sea, Baltic Sea, Eastern Channel and Barents and Norwegian Seas
Workshop on Integrated Ecosystem Assessment	phytoplankton primary production	the Barents Sea and the Norwegian Sea, Central Arctic Ocean.

(IEA) for the Central Arctic Ocean (WKICA)	zooplankton secondary production	the Barents Sea and the Norwegian Sea, Central Arctic Ocean.
Workshop on Spatial Analysis for the Baltic Sea (WKSPATIAL)	stomachs content	Baltic Sea
	large fish index	Baltic Sea
	fish condition (Fulton)	Baltic Sea
	zooplankton abundance	Baltic Sea
Workshop on Scoping for Integrated Baltic Cod Assessment (WKSIBCA)	growth rate	Baltic Sea
	fish condition (Fulton)	Baltic Sea
	sex ratio maturity ogive	Baltic Sea
	ecosystem	Baltic Sea
	cod fishable biomass	Baltic Sea
	environmental: ReproductionVolume	Baltic Sea
	environmental: temperature	Baltic Sea
	environmental: oxygen	Baltic Sea
	food consumption	Baltic Sea
	seals abundance	Baltic Sea
Working Group on Recruitment Forecasting in a Variable Environment (WGRFE)	growth rate	
	fish stock abundance	
Working Group on Operational Oceanographic Products for Fisheries and Environment (WGOOFE)	environmental: temperature	
	environmental: nutrients	
	environmental: oxygen depletions	
	environmental: salinity	
	environmental: spring bloom	
	environmental: co-pepods	
Working Group on Resilience and Marine Ecosystem Services (WGRMES)	ecosystem	
	socio-economic	
Working Group on Integrating Surveys for the Ecosystem Approach (WGISUR)	ecosystem	
	fish abundance	
	marine mammals abundance	
	seabirds abundance	
	zooplankton abundance	
	ichthyoplankton abundance	
Working Group on Integrating Surveys for the Ecosystem Approach (WGIPEM)	growth rate	
	zooplankton biomass	
	zooplankton mortality	
Working Group on	ecosystem: biotic	Celtic Seas and Bay of Biscay and

Ecosystem Assessment of Western European Shelf Seas (WGEAWESS)		Iberian waters
	ecosystem: abiotic	Celtic Seas and Bay of Biscay and Iberian waters
	ecosystem: climate	Celtic Seas and Bay of Biscay and Iberian waters
	ecosystem: hydrography	Celtic Seas and Bay of Biscay and Iberian waters
	ecosystem: nutrients	Celtic Seas and Bay of Biscay and Iberian waters
	ecosystem: phytoplankton	Celtic Seas and Bay of Biscay and Iberian waters
	ecosystem: zooplankton	Celtic Seas and Bay of Biscay and Iberian waters
	ecosystem: fish	Celtic Seas and Bay of Biscay and Iberian waters
	ecosystem: fisheries	Celtic Seas and Bay of Biscay and Iberian waters
Working Group on the Northwest Atlantic Regional Sea (WGNARS)	ecosystem	Georges Bank, Gulf of Maine, and Grand Banks
	socio-ecological	Georges Bank, Gulf of Maine, and Grand Banks
	ecological	Georges Bank, Gulf of Maine, and Grand Banks
	total windstress	Georges Bank, Gulf of Maine, and Grand Banks
	seasonal time-series of air temperature	Georges Bank, Gulf of Maine, and Grand Banks
	cold intermediate layer thickness (CIL)	Georges Bank, Gulf of Maine, and Grand Banks
	Summer Extended Reconstructed Sea Surface Temperature	Georges Bank, Gulf of Maine, and Grand Banks
	timing of sea-ice retreat	Georges Bank, Gulf of Maine, and Grand Banks
	maximum ice volume	Georges Bank, Gulf of Maine, and Grand Banks
	timing of sea-ice retreat	Georges Bank, Gulf of Maine, and Grand Banks
	NAO Index	Georges Bank, Gulf of Maine, and Grand Banks
Working Group on Integrating Ecological and Economic Models (WGIMM)	ecological	
	bioeconomic	
Working Group on Large Marine Ecosystem Programme Best Practices (WGLMEBP)	community	
	non-declining exploited species' (NDES)	
	fisheries-related	
	biodiversity and conservation-based	
	ecosystem (biophysical and	

	socio-economic)	
	of marine living resource management	
	of Coastal Eutrophication (ICEP)	
	New Ecosystem Quality Objective	
	ecological: total biomass of surveyed species	
	ecological: 1/(landings /biomass)	
	ecological: mean length of fish in the community	
	ecological: trophic level of landings	
	ecological: proportion of predatory fish	
	ecological: proportion of non-fully exploited stocks	
	ecological: intrinsic vulnerability index (IVI) of the landings	
	ecological: mean lifespan	
	ecological: 1/coefficient of variation of total biomass	
	environmental: sea surface temperature	
	environmental: chlorophyll a,	
	human dimension: effectiveness and efficiency of fisheries management	
	human dimension: quality of governance	
	human dimension: contribution of fisheries to broader society	
	human dimension: wellbeing and resilience of fisher communities	
Working Group to Demonstrate a Celtic Seas wide approach to the application of fisheries related science to the implementation of the Marine Strategy Framework Directive (WGMSFDemo)	foodweb: typical length (TyL)	Celtic Sea and Western Channel

## **Annex 4. Tables of quality indicators suggested as support for benchmarks**

---

Annex 4 Table 1

Bench- mark	Source: benchmark list				Source: issue lists by stock				WGBIOP				WGBIOP			
	WG	Species / stock	Stock code	Biological parameter	Issue ("top-down")	Solution proposed	External expertise needed	Issue ("bottom-up")	Advice/Comment	Action	Quality indicator*	Reply to WGBIOP2016	Advice taken on-board/considered	Follow-up		
2016A1	HAWG	Sandeel in Division IIIa and Subarea IV	san-34	-	-	-	-	x	-	-	-	-	-	-		
2016A2	WGNSSK	Norway Pout in Subarea IV and Division IIIa	nop-34	-	-	-	-	-	-	-	-	-	-	-		
2016A2	WGWIDE	Norwegian spring spawning herring	her-noss	natural mortality	Additional M - predator relations. Quantifying the predation on herring larvae by mackerel	Work underway at IMR, Norway.	-	x	WGSAM table (see below) not relevant; NSS herring not in table	-	natural mortality	-	-	-		
				maturity	Maturity ogives for recent years should be updated following procedures described by WKHERMAT.	Calculation of maturity ogives for years 2008 ->. Data are available	-	x	WKHERMAT outdated, use WKMSHS protocol.	Contact stock coordinator (Groa)	maturity scaling, maturity timing	no	-	-		
				age	-	-	-	x	EXC held in 2014; different techniques (scales & otoliths); interpretation differences	EXC & WK planned in 2015-2016	age-error matrix; bias; CV; techniques	-	-	-		
2016A2	WGHANSA	Anchovy in Division IXa	ane-pore	age, maturity	Biological parameters (Maturity ogives, weight at age in the stock, etc. are only available for the Spanish part of the IXa South).	Investigate availability of these data to obtain a consistent data series allowing a further (analytical) assessment. Data available (IPIMAR, IEO data bases), but their availability has to be explored.	?	x	[1] According to the Portuguese (Patricia Gonçalves, patricia@ipma.pt & Eduardo Soares, esoares@ipma.pt), age, length, weight and maturity data are collected on the south Portuguese coast. (2) Consult WKSPMAT for maturity protocols	Contact stock coordinator (Cindy)	spatial coverage	Yes	Yes	1. The benchmark issue list will be revisited. 2. Issue of partial data coming from the Ibero-Atlantic façade waters.		
				natural mortality	Natural Mortality is assumed to be equal to the one estimated for Bay of Biscay Anchovy.	Explore different approaches (empirical, etc.) to derive the estimate of Natural Mortality. Data available (IPIMAR, IEO data bases), but their availability has to be explored.	?	x	WGSAM table (see below) not relevant; only North Sea	-	natural mortality	-	-	-		
2016B	WGNSSK	Dab in Subarea IV and Division IIIa	dab-nsea	-	Not all countries collect biological information for dab.	Compile all available data. Commercial sampling; survey data; DATRAS	-	-	-	-	spatial coverage	-	-	-		
				age	-	-	-	-	x	EXC held in 2014 including 1 technique. Different techniques used (sectioned & whole); interpretation differences	EXC & WK planned in 2015. Contact not necessary; stock coordinator = co-chair WK	age-error matrix; bias; CV; techniques	-	-		
2016B	WGNSSK	Witch in Subarea IV, and Divisions IIIa and VIId	wit-nsea	-	-	-	-	-	Informal age-reading workshop between Sweden and Iceland was held in 2014 (only 2 countries age witch). Age reading witch only recently started; too few witch readers	Stock coordinator contacted (WGBIOP member)	age-error matrix; bias; CV; techniques	-	-	-		
2016B	WGNSSK	Whiting in Division IIIa	whg-kask	maturity	maturity ogive	Maturity studies. Sampling during the IBTS-Q1, IBTS-Q1	Within ICES	Clarification of top-down issue, based on stock annex. Commercial catch data without maturity	use MSGAD2 protocol. Could data from the IBTS-Q1/IBTS-Q1 be used?	Contact stock coordinator (Jo)	maturity scaling, maturity timing, maturity ogive	Yes	Yes	Taken into consideration and confirmed that data from IBTS can be used for maturity ogive.		
				age	Inconsistencies in survey indices. Age reading improvements, stock identification.	Age reading intercalibrations. Genetic and/ or otolith chemistry studies	SIMWG/ geneticists / otolith chemistry researchers	-	x	EXC held in 2015 including IVb, VIIe & VIId otoliths, but did not include IIIa otoliths. Interpretation differences. WK will be held in 2016, IIIa otoliths will be included	Contact stock coordinator (Jo)	age-error matrix; bias; CV; techniques	Yes	Yes	IIIa otoliths to be used in WK in 2016.	
2016B	WGNSSK	Saithe in Subarea IV and Division IIIa West (Skagerrak) and Subarea VI	sai-3445	age	Determine if low number of Norwegian commercial samples is creating bias in catch-at-age data.	Evaluate the sampling design (any changes?) and address sampling uncertainty.	-	-	WKARPV 2015: good agreement between readers (>90%)	Contact stock coordinator, (Kelig)	sampling design	Yes	Yes	-		
				age, maturity	Investigate growth and maturity changes.	Growth and maturity curve fitting. DATRAS; survey data	-	-	x	Are current estimates of maturation appropriate? Investigation of growth and maturity changes is proposed	consult MSGAD2 protocol	Contact stock coordinator, (Kelig)	maturity scaling, maturity timing, maturity ogive	Yes	Yes	-
				age	-	-	-	-	x	Lack of 3 year olds in Q3, fish not appearing until year 4	Investigate why this is happening. Is this an ageing problem or sampling design issue	Contact stock coordinator, (Szymon)	-	Yes	Yes	-





no	WGNSSK	Whiting in Subarea IV (North Sea) and Division VIId (Eastern Channel)	weight				Taken from commercial catches, might include IBTS data but this is probably skewed to the younger ages	investigate if IBTS combined with commercial catches cover the full age range	Contact stock coordinator. (Szymon)	-	Yes	Yes	Weights used from commercial catches only. Stock weights-at-age were assumed to be the same as in Total catches.
			maturity				Maturity ogive from data from the 80s, unclear if it is based on combined sexes or female only	This needs to be clear	Contact stock coordinator. (Szymon)	maturity ogive	Yes	Yes	Not known whether females only or combined sexes were taken
			natural mortality				natural mortality is taken from the SMS model (WGSAM) but is set to zero before spawning	natural mortality set to zero before spawning? (stock annex statement)	Contact stock coordinator. (Szymon)	natural mortality	Yes	Yes	Assumed to be spawning early in the year therefore natural mortality was set to 0. (Possibly needs to be validated or adjusted as whiting in Northern Nsea known to spawn up to July).
no	WGNSSK	Sole in Division VIId (Eastern Channel)	natural mortality				Assumed constant over ages and time, and it is set to zero before spawning	natural mortality set to zero before spawning? (stock annex statement)	Contact stock coordinator. (Kellg)	natural mortality	No	?	
			maturity				Knife-edge ogive used, constant over all the years	-	-	maturity ogive			
no	WGNSSK	Sole in Subarea IV (North Sea)	maturity				Knife-edge ogive used based on market samples for females from 60s and 70s. Recent studies show changes in maturity at age	-	-	maturity ogive			
			natural mortality				Assumed constant over ages and time	-	-	natural mortality			
no	WGNSSK	Plaice in Subarea IV & IIIa	natural mortality				Basis for natural mortality questioned. Review the basis for natural mortality. Literature review, model estimates of M	-	-				
no	WGNSSK	Pollack in Subarea IV and division IIIa					General lack of biological data. This is needed for better understanding of growth and maturity.	-	-				
no	WGNSSK	Haddock Subarea IV (North Sea) and Division IIIa (Skagerrak-Kattegat)	maturity				A knife-edged maturity-ogive are used at age 3.	-	-	maturity ogive			

Annex 4. Table 2.

Benchmark	WG/WK	Species / stock	Stock code	Biological parameter	Issue ("top-down")	Solution proposed	External expertise needed	Issue ("bottom-up")	Advice/Comment	Action	Quality indicator*
2017	WKIrish	Haddock in Division VIIa	had-iris	No issue list available	No issue list available	Ask for issue list	Stock coordinator	No issue list available	Please provide issue list		
2017	WKIrish	Plaice in Division VIIa	ple-celt	Growth, maturity	Growth and maturity in this stock may have changed over time. The aim to explore available data to investigate if this is a problem for the assessment and advice.	Review survey data for evidence of spatial and temporal changes in growth rates between sexes. Establish it there is a basis to construct annual maturity ogives from survey or commercial sampling. Do they change significantly?	Stock assessment experts (Tim Earl) timothy.earl@cefias.co.uk	--			Growth parameter, maturity ogive
2017	WKIrish	Whiting (Merlangius merlangus) in Division VIIa	whg-iris	Growth, maturity	Changes in growth and maturity	Document changes and look at impact on reference points	Stock assessment experts (Sara-Jane Moore) sara-jane.moore@marine.ie	--			Growth parameter, maturity ogive
2017	WKIrish	Cod (Gadus morhua) in Division VIIa	cod-iris	No issue list available	No issue list available	Ask for issue list	Stock coordinator	No issue list available	Please provide issue list		
2017	WKIrish	Herring in Division VIIa North of 52 30N		No issue list available	No issue list available	Ask for issue list	Stock coordinator	No issue list available	Please provide issue list		
2017	WKPELA	Sardine in Divisions VIIIa,b,d and Subarea VII	sar-78	No biological parameter issues identified	-	-	-	-	-	-	-
2017	WKPELA	Sardine in Divisions VIIIc and Ixa	sar-soth	weight & maturity at age	Weights-at-age are fixed from 1978-1985 at values far from long term average at certain ages. Weights-at-age and maturity stage are derived from different surveys.	Derive weights-at-age from DEPM survey. Compile data to review weights and maturity-at-age for as many years as possible prior to 1985.	Miguel Bernal	--			Weight-at-age and maturity-at-age
2017	WKPELA	Horse mackerel in Division Ixa	hom-soth	Weight-at-age	Weights-at-age derived from catch are assumed equal to the weight-at-age in stock. But last years show a significant variability in weight-at-age.	Explore other sources to obtain weight-at-age for population more reliable (surveys).	Survey scientists, stock coordinator (Gersom Costas) gersom.costas@vi.ieo.es	--			Weight-at-age
2017	WKNSEA	Plaice in subarea IV and Subdivision III.a.20	ple-nsea	Natural mortality	Review of basis for natural mortality.	Literature review, model estimates of M.	David Miller, Jan Jaap Poos, Tessa van der Hammen (janjaap.poos@wur.nl)	--			Natural mortality
2017	WKNSEA	Sole in Division VIId	sol-eche	Maturity	A knife-edged maturity ogive, with full maturation from age 3 onwards is used in the assessment. No new data have been explored for a long time.	Investigate all available trawl survey maturity data to come up with a maturity ogive that is supported by recent data.	ILVO (Kelle Moreau, colleague to be appointed)	--			Maturity ogive
				Natural mortality	Natural mortality is assumed to be a fixed value (0.1) for all ages across all years, which is unlikely to reflect the biological reality.	Use different methods to estimate natural mortality ogives for testing in the assessment (methodologies as in other ICES benchmark meetings, based on analysis of life-history parameters).		--			Natural mortality
2017	WKFAROE	Cod in Subdivision Vb1	cod-farp	length, weight, maturity	Stock coordinator to clarify	Stock coordinator to clarify	Petur Steingrund (peturs@hav.fo)	--		Ask stock coordinator to clarify (Ruadhán)	Length and weight parameters, maturity ogive
2017	WKFAROE	Haddock in Division Vb	had-faro	length, weight, maturity	Stock coordinator to clarify	Stock coordinator to clarify	Jákup Reinert (jakupr@hav.fo)	--		Ask stock coordinator to clarify (Groa)	Length and weight parameters, maturity ogive

Benchmark	WG/WK	Species / stock	Stock code	Biological parameter	Issue ("top-down")	Solution proposed	External expertise needed	Issue ("bottom-up")	Advice/Comment	Action	Quality indicator*
2017	WKIrish	Haddock in Division VIIa	had-iris	No issue list available	No issue list available	Ask for issue list	Stock coordinator	No issue list available	Please provide issue list		
2017	WKIrish	Plaice in Division VIIa	ple-celt	Growth, maturity	Growth and maturity in this stock may have changed over time. The aim to explore available data to investigate if this is a problem for the assessment and advice.	Review survey data for evidence of spatial and temporal changes in growth rates between sexes. Establish if there is a basis to construct annual maturity ogives from survey or commercial sampling. Do they change significantly?	Stock assessment experts (Tim Earl) timothy.earl@cefias.co.uk	--			Growth parameter, maturity ogive
2017	WKIrish	Whiting (Merlangius merlangus) in Division VIIa	whg-iris	Growth, maturity	Changes in growth and maturity	Document changes and look at impact on reference points	Stock assessment experts (Sara-Jane Moore) sara-jane.moore@marine.ie	--			Growth parameter, maturity ogive
2017	WKIrish	Cod (Gadus morhua) in Division VIIa	cod-iris	No issue list available	No issue list available	Ask for issue list	Stock coordinator	No issue list available	Please provide issue list		
2017	WKIrish	Herring in Division VIIa North of 52 30N		No issue list available	No issue list available	Ask for issue list	Stock coordinator	No issue list available	Please provide issue list		
2017	WKPELA	Sardine in Divisions VIIIa,b,d and Subarea VII	sar-78	No biological parameter issues identified	-	-	-	-	-	-	-
2017	WKPELA	Sardine in Divisions VIIIc and Ixa	sar-soth	weight & maturity at age	Weights-at-age are fixed from 1978-1985 at values far from long term average at certain ages. Weights-at-age and maturity stage are derived from different surveys.	Derive weights-at-age from DEPM survey. Compile data to review weights and maturity-at-age for as many years as possible prior to 1985.	Miguel Bernal	--			Weight-at-age and maturity-at-age
2017	WKPELA	Horse mackerel in Division Ixa	hom-soth	Weight-at-age	Weights-at-age derived from catch are assumed equal to the weight-at-age in stock. But last years show a significant variability in weight-at-age.	Explore other sources to obtain weight-at-age for population more reliable (surveys).	Survey scientists, stock coordinator (Gersom Costas) gersom.costas@vi.ieo.es	--			Weight-at-age
2017	WKNSEA	Plaice in subarea IV and Subdivision III.a.20	ple-nsea	Natural mortality	Review of basis for natural mortality.	Literature review, model estimates of M.	David Miller, Jan Jaap Poos, Tessa van der Hammen (janjaap.poos@wurl.nl)	--			Natural mortality
2017	WKNSEA	Sole in Division VIId	sol-eche	Maturity	A knife-edged maturity ogive, with full maturation from age 3 onwards is used in the assessment. No new data have been explored for a long time.	Investigate all available trawl survey maturity data to come up with a maturity ogive that is supported by recent data.	ILVO (Kelle Moreau, colleague to be appointed)	--			Maturity ogive
				Natural mortality	Natural mortality is assumed to be a fixed value (0.1) for all ages across all years, which is unlikely to reflect the biological reality.	Use different methods to estimate natural mortality ogives for testing in the assessment (methodologies as in other ICES benchmark meetings, based on analysis of life-history parameters).		--			Natural mortality
2017	WKFAROE	Cod in Subdivision Vb1	cod-farp	length, weight, maturity	Stock coordinator to clarify	Stock coordinator to clarify	Petur Steingrund (peturs@hav.fo)	--		Ask stock coordinator to clarify (Ruadhán)	Length and weight parameters, maturity ogive
2017	WKFAROE	Haddock in Division Vb	had-faro	length, weight, maturity	Stock coordinator to clarify	Stock coordinator to clarify	Jákup Reinert (jakupr@hav.fo)	--		Ask stock coordinator to clarify (Groa)	Length and weight parameters, maturity ogive

2017	WKFAROE	Haddock in Division VIb	had-rock	age	Agreement by international experts. Results of age-reading of the identical otoliths differ.	It would be beneficial to develop and introduce standardisation methods for reading the age of haddock. Contact MSS survey scientist for information and MSS age coordinator.	Survey scientist, age coordinator (Jim Drewery, Mandy Gault) Vladimir Khilivnoi khilivn@pinro.ru	--		Ruadhán to contact	Age-at-length/age-at-weight
				weight	The mean weights-at-age in the stock are assumed to be the same as the catch weights.	Contact MSS survey scientist for information and MSS age coordinator.	Survey scientist, age coordinator (Jim Drewery, Mandy Gault)	--		Ruadhán to contact	
2017	WKFAROE	Saithe in Division Vb	sai-faro	No biological parameter issues identified	-	-	-	-	-	-	-
2017	WKBASS	Seabass in Divisions IVb and IVc, VIa and VIId-h	bss-47	mortality, growth	Natural mortality is considered as constant over time at a relatively low value of 0.15, set for all ages. Maturity ogives are based on long-term historical UK sampling data and do not account for any trends that may have occurred. Inappropriate treatment of growth and M could bias the assessment and reference points, whilst not accounting for changes in maturity would bias SSB trends and reference points.	Review evidence for spatio-temporal variation in growth and maturity, and age-dependent M. Examine sensitivity of assessment and advice to this. Develop parameter inputs for future assessments.	Stock assessment expert (Mike Armstrong) mike.armstrong@cefas.co.uk	--			Natural mortality, growth
2017	WKBASS	Seabass in Divisions VIIIA and VIIIB	bss-8ab	age, weight, length, growth, mortality, maturity	No biological parameters available in 2015. Some maturity data available.	Start collecting data on all biological parameters.	Stock coordinator (Michael Drogou) mickael.drogou@ifremer.fr	--			All quality indicators
2017	WKBALT	Herring in Subdivision 30	her-30	maturity	Maturity sampling issue	check issue with coordinator	Jari Raitaniemi, Jukka Pönni, Zeynep Pekcan-Hekim, Pekka Jounela	--		Groa to contact to ask about sampling issue	Maturity ogive
		Herring in Subdivision 31	her-31	maturity	Maturity sampling issue	check issue with coordinator	Jari Raitaniemi, Jukka Pönni, Zeynep Pekcan-Hekim, Pekka Jounela	--		Groa to contact to ask about sampling issue	Maturity ogive
2017	WKBALT	Cod in Subdivision IIIa.21	cod-kat	weight, maturity	For some of the ages; catch weight, stock weight and maturity from commercial sampling and not using survey data.	Use survey data for estimates of biological parameters.	Johan Lövgren, Barbara bland, Francesca Vitale	--			
2017	WKBaltSalmon	Salmon in Subdivisions 22-31		No issue list available	No issue list available	Ask for issue list	Stock coordinator	No issue list available	Please provide issue list		
2017	WKBaltSalmon	Salmon in Subdivision 32		Mortality, maturity, fecundities, sex ratios	Modelling issue, new parameterisation for SR-relationship Spawner stock bio-mass per recruit (SBPR) should be calculated as a function of post-smolt mortality (Mps), natural mortality (M), maturation rates, fecundities and sex ratios, instead of giving it a prior distribution (as current-ly). Because Mps and maturation rates vary in time, SBPR would also vary.	The consequences of the new parametrization will be explored in the benchmark. Model for predicting the maturation by sea surface temperature and update of fecundity parameter values) will be reviewed in the benchmark if seen necessary.	Johan Dannewitz (Stock coordinator) and Henni Pulkkinen (stock assessor) johan.dannewitz@slu.se & henni.pulkkinen@luke.fi	--			
2017	WKWIDE	Mackerel in Subareas 1-7 and 14 and Division VIIIA-e, IXa	mac-nea	No biological parameter issues identified	-	-	-				
2017	WKWIDE	Horse Mackerel in Subarea 8 and Divisions IIa, IVa, Vb, VIa, VIIa-c, e-k	hom-west	Weight-at-age	Lack of data available for younger ages in area VIIj period 1,2. Biological parameters issue box missing.	Explore another source of information in order to estimate mean weight-at-age for stock.	Gersom Costas (stock coordinator) gersom.costas@vi.ieo.es	--			
2017	WKWIDE	Horse Mackerel in Divisions IIIa, IVb, c and VIId		No issue list available	No issue list available	Ask for issue list	Stock coordinator		Please provide issue list		
2018	WKAnglerfish	White anglerfish in Divisions VIIIC and IXa	Ang-8c9a	No issues identified	No issues identified	No issues identified	No issues identified				
2018	WKAnglerfish	Black-bellied anglerfish in Divisions VIIIC and IXa		No issue list available	No issue list available	Ask for issue list	Stock coordinator				

2018	WKAnglerfish	Black-bellied anglerfish in Divisions VIIb-k and VIIIa,b,d	Ang-78ab	species	Split of the landings between species of anglerfish not known for some countries and there is a possibility that for some years this has not been done/sampled correctly due to differences between species proportion among different countries fishing the same grounds.	Have the historical detailed information on methods used by each country, historically apply the split between species from the best identified method/country/fleet (i.e. the proportions in landings of countries splitting the species due to market reasons...).	Iñaki Quincoces (L.piscatorius), Lisa Readdy (L.budegassa)	--			
2018	WKAnglerfish	White anglerfish in Divisions VIIb-k and VIIIa,b,d	Ang-78ab	species	Split of the landings between species of anglerfish not known for some countries and there is a possibility that for some years this has not been done/sampled correctly due to differences between species proportion among different countries fishing the same grounds.	Have the historical detailed information on methods used by each country, historically apply the split between species from the best identified method/country/fleet (i.e. the proportions in landings of countries splitting the species due to market reasons...).	Iñaki Quincoces (L.piscatorius), Lisa Readdy (L.budegassa)	--			
2018	WKAnglerfish	Anglerfish in Subareas I and II	ang-arct	age	Only historic readings for limited time. The illicium is the structure used. Work has to be initiated to provide such data.	Look to Iceland for verification of age reading.	Otte Bjelland (Stock coordinator)otte.bjelland@imr.no	--	Groa to contact		
				maturity	Harmonise international view. Different maturity ogives.	Ref. Nordic project	Otte Bjelland (Stock coordinator)otte.bjelland@imr.no	--			
2018	WKAnglerfish	Anglerfish in Subareas IV, VI and Division IIIa		no issue list available	No issue list available	Ask for issue list	Liz Clarke (Stock coordinator)		Ruadhán to contact		
2018	WKRED	Redfish <i>Sebastes mentella</i> in Subareas I and II	smn-arct	weight	Poorly explained fluctuations in WAA lead to important variations in SSB.	Re-analyse historical weight data from the fishery and from surveys.	Stock assessor (Pavel Murashko) murashko@pinro.ru	--			
					The weight-at-age in the catch and stock may be different, but this is not currently considered.	1) Re-analyse historical weight data from the fishery and from surveys, 2) allow the model to use 2 different datasets for WAA.	Stock assessor (Pavel Murashko) murashko@pinro.ru	--			
				mortality	Current age range (12-18) is not representative of the fishing mortality experienced by the adult stock (mostly 19+).	Evaluate the impact of using different age range for F.	Stock assessor (Pavel Murashko) murashko@pinro.ru	--			
2018	WKRED	Redfish <i>Sebastes norvegicus</i> in Subareas I and II	smr-arct	mortality	Current age range (12-19) is not representative of the fishing mortality experienced by the adult stock.	Evaluate the impact of using different age range for F better covering older fish.	Stock assessor (Daniel Howell) daniel.howell@imr.no	--			
2018	WKBOAR	Boarfish		no issue list available	No issue list available	Ask for issue list	Stock coordinator				
2018	WKDEEP	Roundnose grenadier in Subareas VI-VII and Divisions Vb and XIb	rng-5b67/rng-soth	growth	Estimates of $r$ (intrinsic growth rates of the surplus production model) are possibly too high in regards of stock dynamics. Work is proposed to derive $r$ from annual length distribution rather than the current fixed distribution for the whole time series.	Analysis on length structure to derive yearly changes in biomass and derive its gross rate.	People involved working on length based identification of population growth parameters. Lionel Pawlowski (stock leader) lionel.pawlowski@ifremer.fr	--			
2018	WKDEEP	Ling in Division Vb	lin-faro	no issue list available	No issue list available	Ask for issue list	Lise H. Ofstad				
2018	WKNSEA	Witch in Subarea IV and Divisions IIIa and VIII d	wit-nsea	mortality, weight-at-age, natural mortality	Series need to be updated, are available.	SLU AQUA will collate and update the biological data	none	--			

Annex 4. Table 3.

Quality indicator	Biological parameter	Type of indicator	Description	Further clarification	Further reading	Grading
sampling design - surveys	all biological param	qualitative/quantitative	Statistically sound sampling usually accounted for by the survey working group	Were possible weaknesses of the survey manual critically assessed?	e.g. ITBSWG, WGBIFS	Quality of biological data not evaluated Preliminary analyses of quality of biological data Detailed analysis of the quality of biological data
sampling design - discards	all biological param	qualitative/quantitative	Level of statistical soundness of national sampling schemes; clear definitions of primary, secondary, tertiary sampling units etc.; see EUMAP annual work by country; focus on countries with major TAC of stock	Has the quality of national sampling schemes used to collect biological material been thoroughly evaluated? How representative are the commercial samples? Are there serious differences in the data from certain countries?	WKACCU, WKPRECISE, WGISDAA, WKMATCH, WGCATCH, WGPICS, SGPIDS	refer to annual evaluation of national work plans by STECF
sampling design - landings	all biological param	qualitative/quantitative	Level of statistical soundness of national sampling schemes; clear definitions of primary, secondary, tertiary sampling units etc.; see EUMAP annual work plan by country; focus on countries with major TAC of stock	Has the quality of national sampling schemes used to collect biological material been thoroughly evaluated? How representative are the commercial samples? Are there serious differences in the data from certain countries?	WKACCU, WKPRECISE, WGISDAA, WKMATCH, WGCATCH, WGPICS, SGPIDS	refer to annual evaluation of national work plans by STECF
spatial coverage	all biological param	qualitative	Is the full range of the stock covered by biological sampling?	Has the quality of national sampling schemes used to collect biological material been thoroughly evaluated? How representative are the commercial samples? Are there serious differences in the data from certain countries?		e.g. evaluate distribution maps of national VMS tracks and commercial samples
Stock identity	mixing ratio	quantitative	Understanding of mixing between stocks	Is there evidence for mixing? What methods are used to identify stock components? How reliable are spatio-temporal patterns in mixing resolved?	WGSIM	No mixing Mixing exists: not accounted for Mixing exists: accounted for, not validated Mixing exists: thorough genetic study as a baseline Mixing exists: thorough genetic study and poor spatio-temporal coverage of mixing Mixing exists: thorough genetic study and good spatio-temporal coverage of mixing
Validation study	age	qualitative	Age-validation study of calcified structure	Is there an age validation study available? What was the method of age validation?	Table 1 of Campana 2001	no validation study only one method with major limitations several complementary age validation methods showing similar results
Validation study	maturity	qualitative	Comparison of macroscopic and histological analyses	Where gonad stages compared with macroscopic and histological methods?	maturity staging workshops - see repository at <a href="http://www.ices.dk/community/Pages/PGCCDBS-doc-repository.aspx">http://www.ices.dk/community/Pages/PGCCDBS-doc-repository.aspx</a>	No validation study Validation by histology available Validation criteria on histology available
Method: structures used	age, maturity	quantitative	Comparison of structures used between national fisheries laboratories; number of techniques used (e.g. whole vs sectioned otoliths, otoliths vs scales); for maturity: macroscopic, whole mount or histology	Preparation of a table (country, method, and the relative TAC or landings share by country); more than 1 technique may be an advantage (corroboration) or a disadvantage (discrepancies). Maturity: whole mount and histology are validations of the staging		No overview table Overview table available Overview table complete and up-to-date

Method: preparation of stage, maturity		quantitative	Comparison of methods used to analyse the structures; number of techniques used (e.g. whole vs sectioned otoliths, otoliths vs scales); for maturity: macroscopic, whole mount or histology	Preparation of a table (country, method, and the relative TAC or landings share by country); more than 1 technique may be an advantage (corroboration) or a disadvantage (discrepancies). Maturity: whole mount and histology are validations of the staging		No overview table Overview table available Overview table complete and up-to-date
Definitions of assigning age, maturity		quantitative	Comparison of national definitions to assign age; birthdate consistency; January 1st or other date; consistency in the interpretation of the otolith edge with reference to birthdate	Definitions of fish birthdays may differ between countries. Preparation of a table (country, definition(s)); Northern European countries often use Jan. 1st, Mediterranean countries may use different birthdates. This may cause confusion. Fish are (usually) aged assuming January 1st as birthdate, ring count is not always the same as age. The period in which ring count is unequal to age depends on species, region and whether opaque or translucent rings are counted.	WKARA 2009, anchovy exchange report in prep, WKARP2010, WKARDL2015	No comparisons between labs Differences between labs are known but ignored Definitions clearly documented and considered in data compilation
History of scaling	maturity	qualitative	Maturity scale (in)-consistencies between countries over time	Do differences between countries exist(ed)? Have different national maturity scales been successfully merged into one international standard?	e.g. WKMSHS, DATRAS, WKMATCH2012	No chronicle available Differences between labs are known but ignored Chronicle clearly documented and considered in data compilation
Timing	maturity	qualitative	The quality of macroscopic maturity staging depends on the time of year and is species/stock specific. E.g. the most reliable estimation for NS flatfish is three months before the spawning season.	Is the maturity sampling harmonized between countries? Is the maturity staging conducted during the whole year or only during a specified period of the year?	e.g. WKMSHS	restricted staging period (e.g.: If Q1 is advised: Q1= good, Q2&Q3=bad, Q4=moderate) all countries staging yearround
ogive	maturity	qualitative	knife-edge, fixed ogive, spatially and/or temporally varying ogive	If sufficient maturity data are available, then spatially and/or temporally varying ogives are considered to be the best approach. Sexual dimorphism occurs in many species, but sexes separate ogives are only applicable in sexes separate stock assessments.		varying ogive = good, ogive = moderate; knife-edge = poor Or: careless use of a type of ogive careful selection of a type of ogive thorough analysis of all options and clear conclusions for selection of a type of ogive
coding	sex	qualitative	Different countries use different coding for male and female in their national databases (e.g. 1 can be either M or F depending on country or even between institutes)	This should be standardised before the data are submitted to ICES, but there is a risk of errors.		No overview table Overview table available Overview table complete and up-to-date
sex-specific parameters	all biological parameters	qualitative	Sexual dimorphism occurs in many species (e.g. flatfishes), but sex-specific parameters such as weights-at-age data are only applicable in sex-specific stock assessments.	Is sex-specific information available and needed? Are the samples sizes per strata representative to allow for sex-specific conclusions?	WKPLE, WKBALFLAT	Sex-specific issues not evaluated Preliminary analyses of sex-specific issues Detailed analysis of sex-specific issues Use of sex-specific issues in the assessment
Exchange/workshop	age, maturity	quantitative	History of past exchanges	When was the last exchange? Did age readers from major data contributors change?	WKNARC2, see repository at <a href="http://www.ices.dk/community/Pages/PGCCDBS-doc-repository.aspx">http://www.ices.dk/community/Pages/PGCCDBS-doc-repository.aspx</a>	No exchange Exchange long time ago and poor results Exchange recently, results poor Exchange long time ago and good results Exchange recently, good results Exchange recently, very good results
absolute bias	age, maturity	quantitative	measure for accuracy in relation to true age (seldom available) or histological analysis of maturity	To be able to use this as an quality indicator for age, the age range must be fixed by species/stock	WKSABCAL, WKNARC2	Age: <0.5 by age group and reader = OK Maturity: no definitions available yet
relative bias	age, maturity	quantitative	measure for accuracy in relation to modal age or modal maturity	To be able to use this as an quality indicator for age, the age range must be fixed by species/stock	WKSABCAL, WKNARC2	Age: <0.5 by age group and reader = OK Maturity: no definitions available yet
CV or APE	age, maturity	quantitative	measure for precision	Age range fixed by species or stock. Grading stock specific, depending on the difficulty to age-read	WKSABCAL, WKNARC2	Stock specific; no preliminary definitions available
% agreement	age, maturity	quantitative	measure for accuracy and precision combined	Age range fixed by species or stock. Grading stock specific, depending on the difficulty to age-read	WKSABCAL, WKNARC2	Stock specific; no preliminary definitions available



error matrix	age, maturity	quantitative	see WKSABCAL report 2014	Variance structure directly visible and useable for stock assessment	WKSABCAL, WKNARC2	Error matrix not available Error matrix available
error matrix used in assessment	age, maturity	quantitative	see WKSABCAL report 2014	Variance structure directly into stochastic stock assessment	WKSABCAL, WKNARC2	Error matrix not used in assessment Error matrix used in assessment
source of information: M	natural mortality	qualitative	On what information is the value for natural mortality based?	(Additional) natural mortality can be estimated (based on predator-prey studies), extrapolated from neighbouring regions for which estimates are available, or assumed.		estimated = good, extrapolated = moderate, assumed = poor
source of information: Growth	growth parameters	qualitative	On what information are growth parameters based (e.g. survey data)? Has the effect of growth form alternative data sets been assessed (e.g. direct tagging data)?	Growth parameters are used in the Nephrops assessments. These parameters can be estimated (based on tagging studies), extrapolated from neighbouring regions for which estimates are available, or assumed.		estimated on direct measurements = very good, estimated indirectly = good, extrapolated = moderate, assumed = poor
source of information: new parameters (e.g. condition factor)	new parameters like condition factor	qualitative	Has the potential of new parameters been considered or included in the data compilation and input to stock assessment	Use of new parameters could improve stock assessments.		-
Stock assessment: traditional	all biological parameters	quantitative	Traditional stock assessment sensitivity runs	Sensitivity runs show the uncertainty introduced by certain data sets used in the stock assessment		No sensitivity runs tested 2 sensitivity runs tested Numerous alternative sensitivity runs tested
Stock assessment: Sensitivity	all biological parameters	quantitative	Stock assessment run with alternative input data sets (e.g. catch data raised by selected biological data only)	Sensitivity runs will show effects of different biological data sets (e.g. age) on the assessment outcomes in terms of key parameters such as fishing mortality F and spawning stock biomass (SSB); however, InterCatch would have to facilitate the compilation of alternative data sets	WKSIBCA	No alternative input data sets produced 2 alternative data sets produced and sensitivity runs tested Numerous sensitivity runs with alternative data sets tested

#### **Annex 4 Table 4: Development of quality indicators of biological parameters used in benchmarks of fish stocks**

The biological parameters collected from shared stocks within the EU data collection framework (DCF) are part of a complex work flow from field sampling (commercial catches, fisheries-independent surveys), analysis and raising to model outputs from stock assessment that end up in advice for decision-makers.

The quality of the biological parameters is not only influenced by the precise and accurate determination of e.g. age or maturity stage itself. The quality is also affected by previous work steps (e.g. statistically sound catch sampling schemes, quality of scientific survey) and subsequent procedures (e.g. inconsistencies in age reading between countries) can severely affect the outcome of stock assessments. However, the consequences of the quality of biological parameter estimates on the fish stock assessment are often inadequately evaluated.

Therefore, we developed a quality indicator scheme covering the entire work flow from the data collection to the stock assessment model runs. The work flow was subdivided into eight topics:

- 1 ) Sampling design
- 2 ) Stock identity
- 3 ) Validation studies
- 4 ) Methods and definitions
- 5 ) Exchanges and workshops
- 6 ) Error matrix
- 7 ) Other biological parameters like M and growth
- 8 ) Stock assessment: Sensitivity runs

Annex 4, Table 4 contains proposed quality indicators for existing and potential biological parameters. In this table for each of the topics, one or more items were listed (e.g. topic "Exchanges and workshops" with the items absolute bias, relative bias, CV or APE, % agreement). For each item there are further descriptions, clarifications and a proposed grading scheme and Figure Y contains a draft schematic summary of the essential work steps that may be considered in a quality control scheme of biological data.

Each of the eight topics is briefly specified below.

1. Sampling design: The use of a statistically sound national catch sampling scheme is the crucial starting point of any data collection. Clear definitions of primary, secondary, tertiary sampling units etc. are needed. The new EUMAP annual work plans will contain this information by country. The work plan will be evaluated by the STECF and their evaluation can be used to assess the quality the national data collection schemes. There should a focus on countries with major TAC of a particular stock.

Fisheries-independent surveys are usually quality-controlled. Yet, there may be shortcomings that may require re-evaluation (e.g. biased or incomplete coverage of subdivisions with biological samples). If a country with minor TAC covers a large area of the scientific survey, a problem in age reading in this country may not have a large effect of the numbers-at-age of the commercial catches but will have a large effect on the age data of the survey indices. The worst case would be a country with ageing bias having both a large TAC and large survey area coverage.

2. Stock identity: If there is evidence of mixing between stocks, researchers should account for this uncertainty in the sampling and the subsequent processing of biological parameters. Efforts should be put to assign fish individuals to their stock of origin to reliably determine spatio-temporal patterns in mixing. Mixing ratios of different spatial and temporal scale could be produced. The use of different stock identification methods are advised, genetics often providing the baseline.
3. Validation studies: Validation studies are the backbone to provide accurate and precise estimates of biological parameters such as fish age (Campana 2001). In many ICES fish stocks, the true age has not been validated, yet the uncertainty inherent in the age data is often not adequately expressed and accounted for in the stock assessment.
4. Methods and definitions: In shared stocks, problems may arise by simple differences in routine methods to determine e.g. age or maturity stage between the countries involved in fish stock assessment. This may involve for instance the use of different maturity scales, codes for sexes, birthday definitions, or ways of preparing otoliths. There may also be historical changes in methods that need to be taken into account when preparing long term dataserries. Accounting of these differences is important to assure the quality of data compiled from different countries.
5. Exchanges and workshops: Exchanges and workshops usually determine the level of agreement between age readers or maturity stages for a selection of hard structures or gonads. The level of agreement is then considered to be representative of the routine work of the experts when analysing hard structures or gonads in their national laboratory. Several metrics are used to determine the level of (dis-)agreement between experts.
6. Error matrix: WKSABCAL (ICES 2014b) highlighted the need and usefulness of error matrices to quantify the level of agreement in aging and maturity staging. While an error matrix can be easily produced, the stock assessors may have to be convinced and the stock assessment model may have to be adapted to allow for incorporation of an error matrix in the calculations.
7. Other biological parameters like M and growth: Parameters such as M and growth can be key parameters used in stock assessment. However, their estimation is often challenging and estimates other than those ultimately used in the assessment could also be considered. Therefore, a critical evaluation of these parameters (and sensitivity runs – see below) may be advisable.
8. Stock assessment: Sensitivity runs: The influence of different datasets is usually assessed by sensitivity runs of the stock assessment model. This usually involves leaving out certain datasets (e.g. survey series, recreational fisheries) to assess their effect on the stock assessment outcome. The commercial catches, which are sampled by often very divergent national schemes, are currently mostly compiled using Inter-Catch which is the major tool for the preparation of an international dataset of commercial catch data used in ICES fish stock assessments.

Annex 4 Table 5

Benchmark	WG	Species / stock	Stock cod	Biological parameter	Issue ("top-down")	Solution proposed	External expertise needed	Issue ("bottom-up")	Advice/Comment	Action	Quality indicator*
2017	WGWIDE	Mackerel, subareas 1–7, 14, and in divisions 8.a–e and 9.a (Northeast Atlantic)		maturity	Revision on the calculation method of the maturity ogive	?	-	x	WKMSMAC2 showed that most institutes were reporting maturity in there national scale, only a few reported in the 2007 agreed international scale. The WKMSMAC2 report contains conversion tables from the national scales to the international agreed scale.	Contact stock coordinator (Cindy)	maturity scaling, maturity timing
				natural mortality	?	?	-	Clarification of top-down issue based on stock annex: Natural mortality (M) has been fixed at 0.15 for decades. This value was calculated based on estimates of total mortality derived from tagging data combined with catch data (Hamre, 1980).	A table of natural mortality of many North Sea species is available on the WGSAM website under links. However, not relevant for this species, mackerel is not in the table.	-	natural mortality
				stock structure	Uncertainty regarding wether there exist a North Sea component, and if so, if protection measures are resonable.	1a) Is there a need for protection measures for the North Sea component 1b) Is it possbile to split catches in the North Sea into different components	-	-	-	-	-
no	WGNSSK	Sole in Division VIII (Eastern Channel)		natural mortality	A knife-edged maturity ogive, with full maturation from age 3 onwards is used in the assessment. No new data have been explored for a long time.	Investigate all available trawl survey maturity data to come up with a maturity ogive that is supported by recent data.	ILVO (Kelle Moreau, colleague to be appointed)	Assumed constant over ages and time, and it is set to zero before spawning	natural mortality set to zero before spawning? (Stock annex statement)	Contact stock coordinator (Kelig)	natural mortality
				maturity	Natural mortality is assumed to be a fixed value (0.1) for all ages across all years, which is unlikely to reflect the biological reality.	Use different methods to estimate natural mortality ogives for testing in the assessment (methodologies as in other ICES benchmark meetings, based on analysis of life-history parameters).		Knife-egdge ogive used, constant over all the years	-	-	maturity ogive

Annex 4 Table 6

Table	Stock code	age - %agreement	age - CV	age - #countries	age - #techniques	age - birthdate	age - scheme	maturity ogive
Mackerel, subareas 1–7, 14, and in divisions 8.a–e and 9.a (Northeast Atlantic)		Percentage agreement ranged from 20% to 100%, with an average of 67.6%. WKARMAC 2010	precision coefficient of variation was 23.8%. WKARMAC 2010	12	9	1st January (WKARMAC 2010)	One opaque zone and one translucent (hyaline) zone constitutes one year of growth (annulus) (WKARMAC 2010)	
Sole in Division VIIId (Eastern Channel)	Sole in Division VIIId (Eastern Channel)	96.80%	1.10%	3 (Belgium, France, UK England)	Transverse section	1st January	good	knife-edge = poor

**Annex 4.7 Case study sole 7d: Maturity data from Belgian commercial catches**Period: Quarter 1,2 and 4; Years: 2004-2015

---

Stage 1 -&gt; Immature

Stage 2 -&gt; Maturing

Stage 3 -&gt; Spawning

Stage 4 -&gt; Spent

Stage 5 -&gt; Resting / Skipped mating

Total number of records in commercial data (market sampling) available: 4039 records

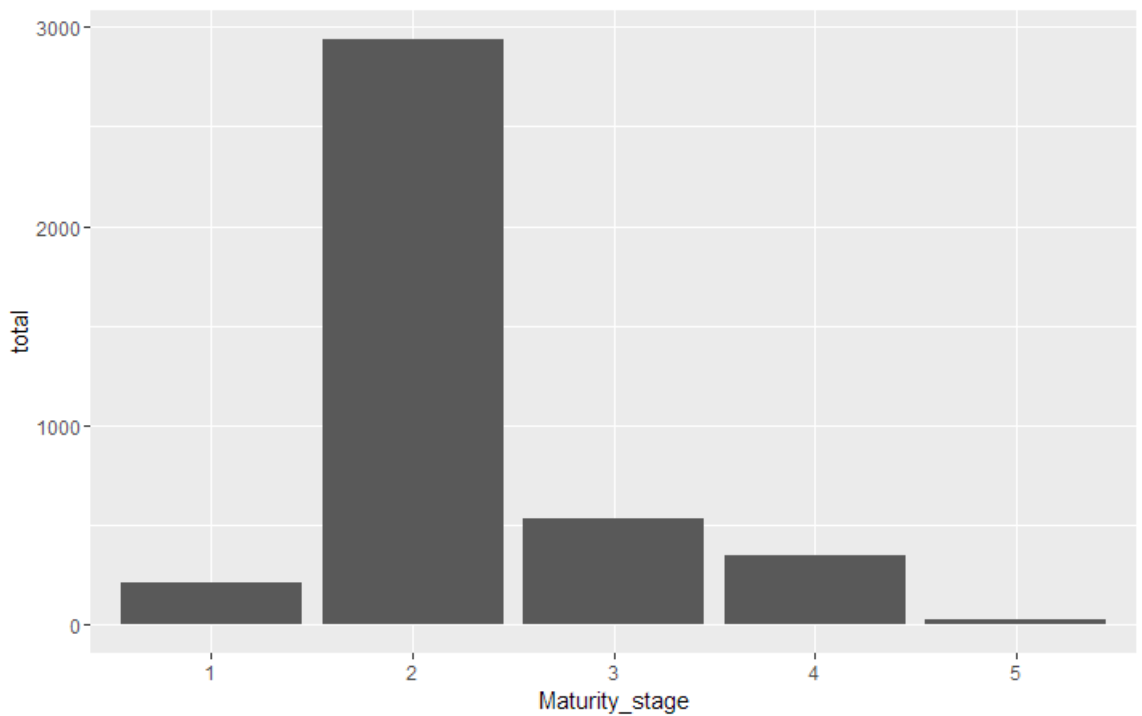
**Figure 1. Number of records per maturity stage**

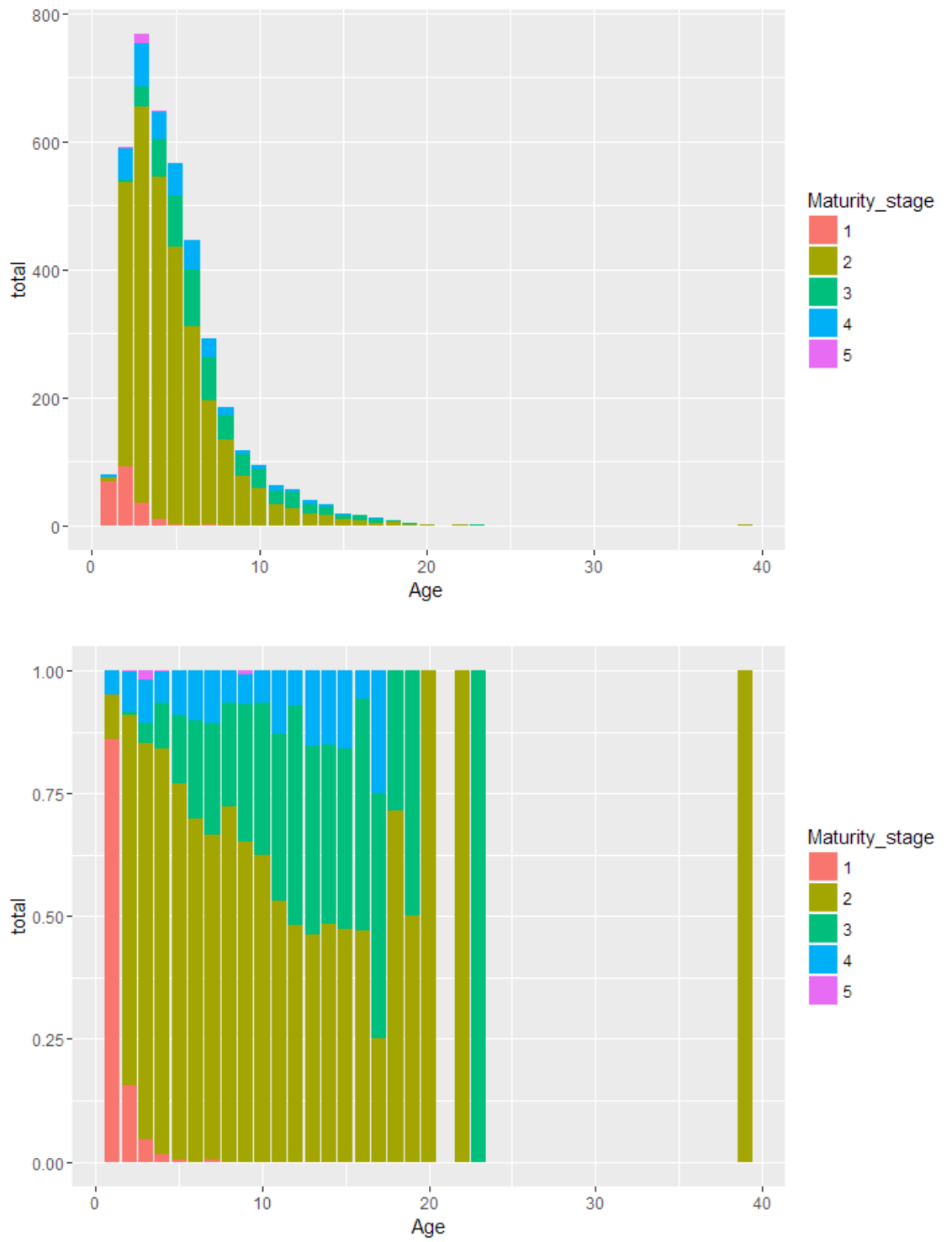

Figure 2. Maturity per age

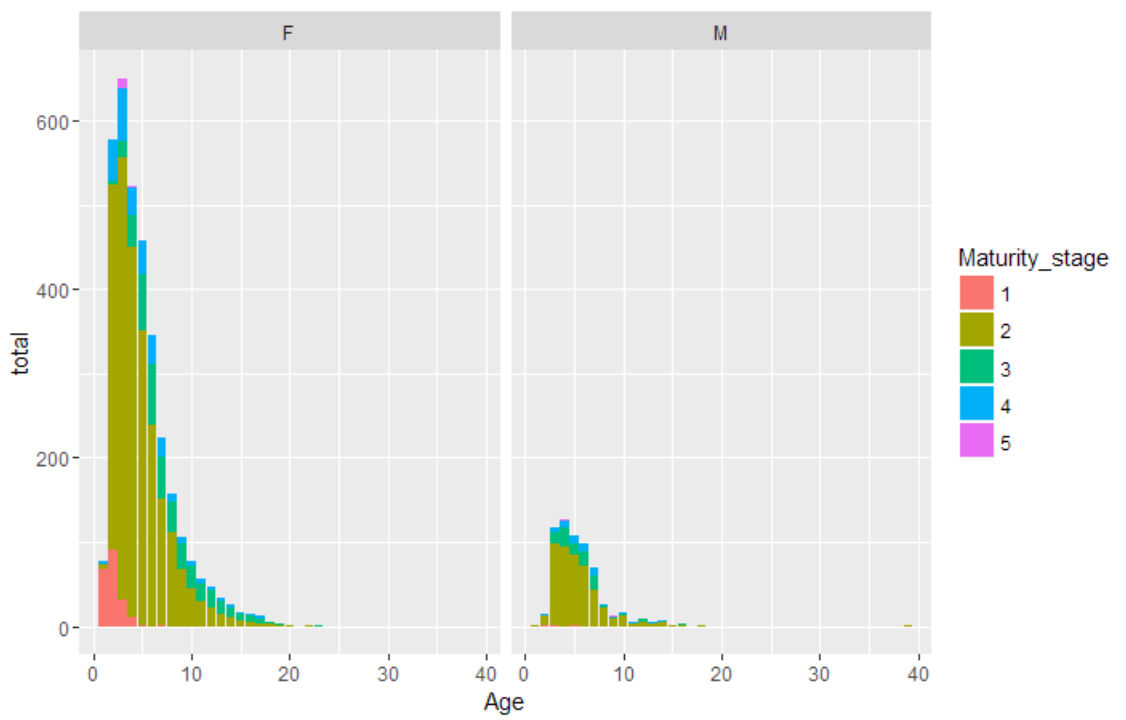

Figure 3. Maturity per age per sex

Total records available per sex: Female: 3414, Male: 625 records



## Annex 4.8 Maturity ogive evaluation for sole 7d

### Issue

In assessment model it is assumed that age 3 is 100% maturity. The below evaluation checks if this assumption is still valid.

### Method

- 1) Check the ICES DATRAS database for presence of maturity data from surveys (IBTS and CGFS (=Celtic groundfish survey))
- 2) Do an analysis of the Belgian commercial maturity data

### Data call

Check if other sources on maturity data are available

### Results of the data call

First inventory of maturity data in the ICES DATRAS:

#### **IBTS**

Query from 1965 till August 2016 – all countries, all vessels. A filter was used on the sole data: where maturity is missing '-9', where Age is missing '-9', and for the whole area 7d (i.e. all ICES Rectangles within this division).

Only data Quarter 1 available, but this is the period where we need to evaluate the maturity data. In total 137 records (CA) were available.

**CGFS:** no sole maturity data in DATRAS

**BTS:** no sole maturity data available in DATRAS

- Only UK sampled in area 7d. However: wrong quarter, thus maturity is not usable.
- Only other data from Q3 & Q4

2 different maturity stage scales were used in the reported data in DATRAS and these were uniformed using the legend below.

#### **Legend for the uniformed maturity stages:**

##### Code

-9 Missing Value

1 Juvenile/Immature (4-stage scale)

2 Maturing (4-stage scale)

3 Spawning (4-stage scale)

4	Spent (4-stage scale)
6	Abnormal (4-stage scale, additional option)
61	Juvenile/Immature (6-stage scale)
62	Maturing (6-stage scale)
63	Spawning (6-stage scale)
64	Spent (6-stage scale)
65	Resting/Skip of spawning (6-stage scale)
66	Abnormal (6-stage scale)

5 maturity stages were used in the commercial catch data. The definition of the stages was checked with the observers.

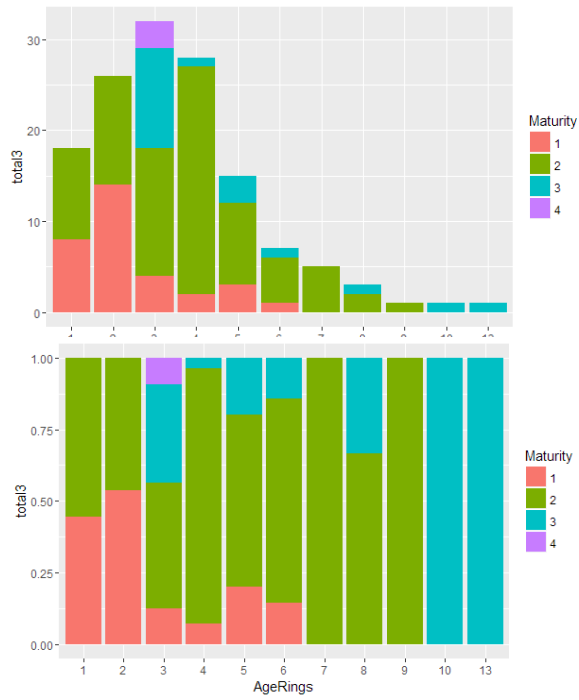

**Figure 1. Results of the evaluation**

IBTS data 1965–2016

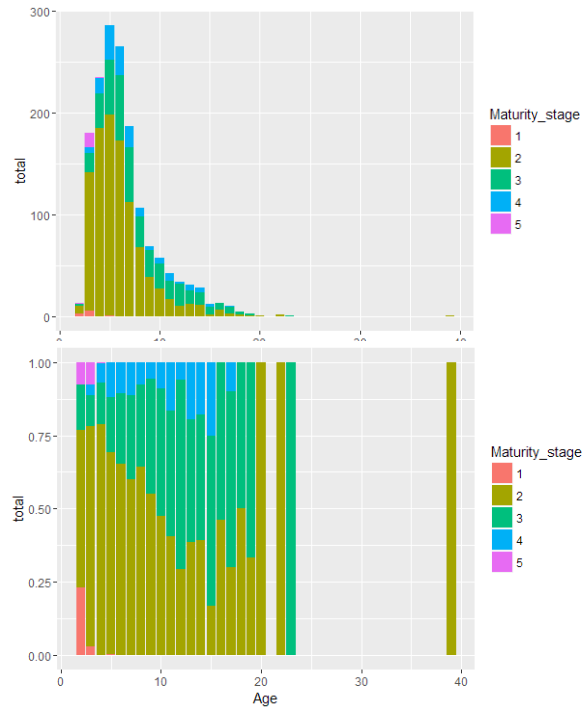

Figure 2. Commercial data 2012–2015. 1580 fish available.

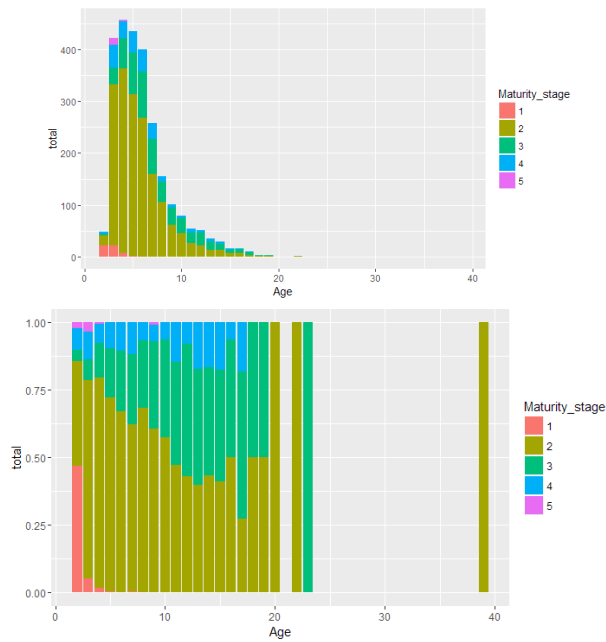

Figure 3. Commercial data 2004–2015 -> 2582 fish available.

Commercial catch data: number of records per year

2004	2005	2006	2007	2008	2009	2010	2011	2012	2013	2014	2015
76	148	175	179	15	59	119	231	255	252	440	633

## Annex 5. Review of past workshops and exchanges

---

### 5.1 Workshops

The following are summaries of the age reading workshops carried out in 2015 and 2016.

#### 5.1.1 Workshop on Age Reading of Chub Mackerel (*Scomber colias*) (WKARCM)

The workshop on age reading of chub mackerel (WKARCM) was held in Lisbon, Portugal, 2-6 November 2015. The meeting was co-chaired by Andreia Silva (Portugal) and Maria Rosario Navarro (Spain) and included 12 participants from three countries.

The aim of this workshop was to review the information on age determination, discuss the results of the previous exchange (2012–2013), review the validation methods existing on these species, clarify the interpretation of annual rings, elaborate an age reading protocol and start a reference collection of well-defined otoliths.

This workshop was preceded by two otolith exchanges (2012–2013 and 2015). Three age validation studies, in three different areas (Bay of Biscay, Portugal and Mauritanian waters) were presented, as well as a compilation of age validation studies of this species in the literature. After the presentation of readings results (mean agreement percentage from 57.5%; mean CV from 29.6%) and the precision of age estimation, the participants identified the sources of bias in the interpretation of the Chub mackerel age. The large number of checks and the position of the first growth ring were identified as the most important problems.

After discussion, a new exercise was made. The precision increased to 60.6% and the mean CV increased to 45.6. Moreover, the number of participants that follow the same age reading criteria increased, although it is still necessary to continue to clarify the age reading interpretation. In consequence, the participants of WKARCM recommended studies on validation methods for *Scomber colias* in all the participating areas and the realization of a new otolith exchange in the following year (2016) to focus on the analysis of exchange results, validation studies and review the age reading protocol for *Scomber colias*.

Recommendations	Addressed to
1. WKARCM workshop in 2016	WGBIOP
2. Clarify guidelines of ageing criteria for chub mackerel	WGBIOP
3. Verification study of the age interpretation criteria	WGBIOP

**WGBIOP 2016 acknowledges the work done and support the clarification of guidelines and the verification study of the age interpretation criteria.**

#### 5.1.2 Workshop on Age Reading of Dab (*Limanda limanda*) (WKARDAB2)

The workshop on age reading of dab otoliths (WKARDAB2) was held in Hamburg, Germany, 17–20 November 2015. The meeting was co-chaired by Loes Bolle (The Netherlands) and Holger Haslob (Germany) and included eight age readers from five countries.

This workshop was preceded by an otolith exchange, which was undertaken using WebGR, consisting of whole (exercise 1) and sectioned (exercise 2) otoliths. The whole otoliths were aged before the workshop using WebGR, the sectioned otoliths were aged at the workshop using stereomicroscopes.

After exercise 1 and 2 were completed, differences in interpretations were discussed by projecting images on the screen. The main conclusions were:

- Stained sections appear to be a promising way to age dab otoliths.
- The biggest problem in the interpretation of dab otoliths is the edge of the otolith. Especially in the case of a translucent zone on the edge of the otolith in the early part of the 3rd quarter, there were clear discrepancies in the interpretation.
- Split rings often occur in dab otoliths, but this did not appear to be a major problem within the current group of experienced readers. In most cases, the whole group agreed on the identification of split rings.

Subsequently, exercise 3 was carried out to examine if the discussions had led to improvement in the consistency of age reading. For this exercise a new otolith set was used (consisting of whole and sectioned otoliths), that had been prepared prior to the workshop in WebGR. Unfortunately, WebGR failed during the workshop and the group had to switch to real material and stereomicroscopes. The results of exercise 3 did not show an overall improvement in the consistency of age reading.

The discussion on stained sections indicated the need to compare whole and stained sectioned otoliths in a calibration exercise. Images were made available at the workshop and it was attempted to initiate a 4th exercise. However, this failed again due to problems with WebGR. Therefore this exercise, in an elaborated form (include 3 methods: whole, sectioned and stained sectioned otoliths; include otoliths from 2 periods and several regions/countries), is now proposed as follow-up action.

No validation studies have been carried out for dab age reading yet. We propose a marginal increment study, to validate the timing of the deposition of opaque and trans-lucent material on the edge of the otolith, as a second follow-up action. The results of such a study will help resolve the encountered problems with the interpretation of the edge of the otolith.

Recommendations	Addressed to
1. Develop the WebGR tool	WGBIOP, ACOM
2. Further investigate different preparation methods (whole, sections, stained sections)	WGBIOP
3. Marginal increment study to resolve problems with the interpretation of the edge of the otolith.	WGBIOP

**WGBIOP 2016 acknowledges the work done and supports the further development of the WebGR tool. WGBIOP recognizes the importance of further investigating different preparation methods. Moreover, WGBIOP agrees on initiating a marginal increment study for clarifying the nature of the otolith edge.**

### 5.1.3 Workshop on Age Reading of Sea Bass (*Dicentrarchus labrax*) (WKARDL)

The workshop on age reading of sea bass (WKARDL) was held in Lowestoft, England, UK, 15–19 June 2015. The meeting was co-chaired by Kélig Mahé (France) and Mary Brown (England, UK) and included seven age readers from three countries.

The objectives of this first workshop were to review, document and make recommendations on current methods of ageing sea bass. This workshop was preceded by otolith exchanges in 2011 and 2013, which were undertaken using WebGR. Participants, who had not taken part in the exchange were asked to annotate the images in the months prior to the workshop. However, due to problems with accessing WebGR only a limited number of the readers managed to do this in time.

Seven readers participated in a scale calibration exercise during this workshop which showed an overall agreement of 78.2% (ranging between 29% and 100%) with a precision of 5.2% CV (ranging from 0 to 13%). Of the 55 scales, 24 (43%) were read with 100% agreement. The image analysis exercise clarified that the lack of agreement can be due to the difficulty identifying the position of the first *annulus*, the presence of checks and the dates of sample collection.

The workshop achieved quite a lot in terms of ironing out, through discussion and calibration, some of the major difficulties in ageing otoliths of sea bass. This group recommend use of scales for sea bass ageing. For future exchanges, it would be beneficial to compare unstained otolith sections with transmitted and reflected lights and stained otolith sections, with the scales. For scale exchanges, the group recommend the use of multiple scale images (or videos) for each fish. The group reached agreement on a definition of an ageing guideline and a reference collection presented in this report and the aim is to employ these tools for all laboratories.

Recommendations	Addressed to
1. WKARDL2 Workshop in 2021	WGBIOP, WGCSE, WGBIE, ACOM
2. Otolith and Scale Exchange of <i>D. labrax</i> in 2019	WGBIOP, WGCSE, WGBIE, ACOM
3. Clarify the ageing criteria guideline	WGBIOP, WGCSE, WGBIE, ACOM
4. Develop the WebGR tool	WGBIOP, ACOM

**WGBIOP 2016 acknowledges the work done and agrees on scheduling the future workshop in 2021 and exchange in 2019. Also WGBIOP supports the clarification of guidelines and the further development of the WebGR tool.**

### 5.1.4 Workshop on Age reading of Horse Mackerel, Mediterranean Horse Mackerel and Blue Jack Mackerel (*Trachurus trachurus*, *T. mediterraneus* and *T. picturatus*) (WKARHOM2)

The workshop on age reading of horse mackerel, Mediterranean horse mackerel and blue jack mackerel (WKARHOM2) was held in Santa Cruz de Tenerife, Canary Islands, Spain, 26–30 October 2015. The meeting was co-chaired by Kélig Mahé (France) and Pierluigi Carbonara (Italy) and included 12 age readers from six institutes (five countries).

The objectives of this workshop were to review, document and make recommendations on current methods of ageing *Trachurus* species.

This workshop was preceded by otolith exchanges in 2014, which were undertaken using WebGR. A total of 550 fish was sampled from the Atlantic Ocean (Eastern Channel, Celtic Sea, Bay of Biscay, Azores, Portuguese waters and Tenerife) and the Mediterranean Sea (Alboran Sea, South Adriatic Sea and Ligurian Sea). 19 readers from 8 countries (France, Germany, Spain, Ireland, Italy, Portugal, Netherlands and Norway) participated to this exchange. Among three *Trachurus* species, all data showed a very low precision with the percentage of agreement between 47 and 56% and a CV from 29 to 69%. The precision analysis showed the same level of precision between otolith sections and whole otoliths from the Ligurian Sea.

The workshop achieved quite a lot in terms of ironing out, through discussion and calibration, of some of the major difficulties in ageing otoliths of *Trachurus* species. The results of the comparison between different ageing techniques on the same set of fish, showed a bias intra-reader and so it is recommended to use only one ageing technique by each reader. Moreover, the precision of reading is the same between slices and whole otoliths and so there is not a best ageing technique for *T. trachurus*. The progress of reading showed a percentage of agreement close to 65% for *T. trachurus* and *Trachurus picturatus*. However, the percentage of agreement for *Trachurus mediterraneus* remained to 44.4% with a CV to 40. In fact, the next exchange must be target *Trachurus mediterraneus* as a priority. Finally, this group reached an agreement on a definition of an ageing guideline and a reference collection presented in this report and the aim is to employ these tools for all laboratories.

Recommendations	Addressed to
1. Update guidelines by species for the ageing analysis.	WGBIOP, National Ageing Coordinators
2. WKARHOM2 workshop in 2018.	WGBIOP, ACOM
3. Improve the ageing coherency (i.e. the marginal analysis and taking measurements between the rings).	WGBIOP
4. Improve the study of spawning on <i>T. mediterraneus</i> in the Atlantic to solve the question of birthday for this species.	WKMSMAC2
5. Develop the WebGR tool	WGBIOP, ACOM

**WGBIOP 2016 acknowledges the work done and agrees on scheduling the future workshop in 2018. Also WGBIOP supports the improvements in ageing coherence and the study of spawning on *T. mediterraneus* in the Atlantic to solve the question of birthday for this species and the further development of the WebGR tool.**

#### **5.1.5 Workshop on Age Reading of Saithe (*Pollachius virens*) (WKARPV)**

The workshop on age reading of saithe (WKARPV) was held in Boulogne-sur-Mer, France, 26–29 May 2015. The meeting was co-chaired by Kélig Mahé (France) and Jane A. Godiksen (Norway), and included eight age readers from four countries.

The objectives of this first workshop were to review, document and make recommendations on current methods of aging saithe (*Pollachius virens*).

This workshop was preceded by an otolith exchange in 2013, which was undertaken using WebGR. Participants who hadn't taken part in the exchange were asked to annotate the images in the months prior to the workshop, however, due to problems with accessing WebGR only a limited amount of the readers managed to do this in time. The otolith collection included 298 images from the North Sea and the Barents



Sea. The overall agreement with modal age of the pre-workshop exercise was 85.9%, with a precision of 6.2% CV. The images were analysed and the differences discussed and guidelines were established from this discussion. To test the guidelines a set of 50 otoliths from the Barents Sea was read during the workshop. These were read both with reflected and transmitted light and had an agreement ranging between 79.2% and 82.3% with a precision ranging from 3.7% to 4.6% CV. There was clear bias between the individual readers using the two different light sources. Width measurement analysis of the 50 otoliths was carried out in plenary after agreeing on the ages of 48 of the 50 otoliths to determine the continuity of the position of the growth rings.

In general, the understanding of the annual rings was high between the readers, and there was little disagreement, however, since the otolith preparation is different among institutes, there was discussion especially about the perception of the edge. Readers used to reading broken otoliths found it difficult to read the edges of the image of the slides. Therefore, we recommend that both broken and slides are compared during the next saithe exchange along with images on WebGR.

Recommendations	Addressed to
1. WKARPV2 workshop in 2022	WGBIOP, WGNSSK, NWWG, AFWG, ACOM
2. Otoliths exchange of <i>P. virens</i> in 2019	WGBIOP, WGNSSK, NWWG, AFWG, ACOM
3. Clarify guideline of ageing criteria	WGBIOP, WGNSSK, NWWG, AFWG, ACOM
4. Develop the WebGR tool	WGBIOP, ACOM

**WGBIOP 2016 acknowledges the work done and agrees on scheduling the future workshop in 2022 and otolith exchange in 2019. Also WGBIOP supports the clarification of guidelines and the further development of the WebGR tool.**

#### **5.1.6 Workshop on Age estimation of Norwegian Spring-spawning Herring between, Norway, Denmark, Iceland and the Faroe Islands (WKNSSAGE)**

The workshop on age reading of Norwegian Spring-spawning herring (WKNSSAGE) was held in Charlottenlund, Denmark, 9–10 November 2015. The meeting was chaired by Jane A. Godiksen (Norway), and included 12 age readers from four countries.

The objective of this workshop was to get a common understanding of how scales and otoliths are interpreted by examining some pre-annotated scales and otoliths. Concerns over the interpretation of the edge were addressed and there appeared to be very little disagreement in the interpretation of the growth zones in either structure. Thereafter an exercise containing otoliths and scales from the same fish was prepared in WebGR, the actual structures were also available to the readers. The results showed a low level of agreement (52%) between age readings and a general trend appeared where the scales were estimated to be one year older than the otoliths. This led to an apparent loss of the strong year class of 2004. After reviewing

the structures in plenary, it was clear that it was most often the first winter ring in the scale which was not clearly visible in the otolith. In order to review the problem in more detail a numerical analysis was attempted utilizing the measurements extracted from WebGR. A number of shortcomings were noticed when using this approach to identify potential problem areas in the age interpretation. The problems could be associated with mixing of subpopulations and/or stocks.

WKNSSAGE concluded that the different ages obtained from scale and otolith readings could be due to a number of issues relating to identification of the first winter ring and age interpretation of older fish, confounded by stock mixing issues. Final conclusions cannot be reached based on the samples from this workshop. We believe the sampling and stock mixing issues should be addressed separately by WGWIDE.

Recommendations	Addressed to
1. WKARNSSH workshop and pre-workshop exchange 2017 should consider the short-comings of the present workshop	WGBIOP, ACOM
2. Stock mixing issues during the May survey needs to be addressed	WGBIOP, WGIPS, WGWIDE, ACOM
3. Sampling of both structures from the same fish	WGBIOP, WGIPS
4. Standardization / calibration of sampling procedures	WGWIDE, WGIPS, ACOM
5. Implementation of the agreed guidelines by all laboratories	All NSS-herring laboratories

**WGBIOP 2016 acknowledges the work done and agrees on scheduling the future workshop (WKARNSSH) and otolith exchange in 2017 where the short-comings of the present workshop should be considered. Also WGBIOP supports the clarification of stock mixing issues, standardization and calibration of sampling procedures and implementation of the agreed guidelines by all laboratories.**

#### **5.1.7 Workshop on Maturity Staging of Mackerel and Horse Mackerel (WKMSMAC2)**

The workshop on maturity staging of mackerel and horse mackerel (WKMSMAC2) was held in Lisbon, Portugal, 28 September - 2 October 2015. The meeting was co-chaired by Pierluigi Carbonara (Italy) and Cindy van Damme (the Netherlands), and included 32 participants from eight countries (13 institutes).

The meeting aimed to validate the international maturity stages for *Scomber scombrus*, *Scomber colias*, *Trachurus trachurus* and *Trachurus mediterraneus* as proposed by WKMSMAC in 2007 and prepare conversion tables for the maturity scales used by the institutes to the international scale.

The maturity scales as proposed by WKMSMAC2 in 2007 have not been incorporated by all countries. It became apparent that institutes have not been reporting maturity stages to ICES in the international scale. Hence, maturity stages for mackerel and horse mackerel from the different institutes since 2007 do not correspond. Mediterranean countries have all reported in the agreed MEDITS scale.

For all scales, conversion tables are presented to the international agreed scale.

In general, it is important to realize that when countries move to the new maturity keys, a change in the number of spawning fish might occur as the definitions of the various stages might differ between the old national stages and the internationally agreed stage.

As the descriptions of the stages were evaluated, some changes were made in the criteria, based on expertise and experiences. Also criteria for assessing the maturity stage from frozen gonads were added for the species where frozen samples are regularly staged.

Since all species studied in this workshop are batch spawners with a suspected indeterminate fecundity, there is no evidence of the occurrence of omitted spawning (stage 5). Therefore, no description is given for this stage. For some species, abnormal gonads (stage 6) have not been observed, thus the description of stage 6 for those species is left blank.

Three staging exercises were carried out, one using fresh and frozen fish for *Trachurus* and frozen fish for *Scomber scombrus* and two using pictures of all four species. Generally, participants felt that mackerel was easier to stage than horse mackerel. Participants felt that fresh staging was easier than frozen staging and easier than staging from pictures, since (a) touching is one of the components in maturity staging and (b) hyaline oocytes are easier to identify in fresh/frozen samples than from pictures. However, only for mackerel the agreement in maturity stage was higher in the frozen samples compared to the picture staging.

For *Scomber scombrus*, agreement between the expert readers for frozen fish was 77.1%. Agreement for the first picture round was 67.3%.

For *Trachurus trachurus*, agreement between experts in fresh fish was only 56.0%, for frozen fish agreement was 61.7%, agreement for the pictures was 68%.

For *Scomber colias*, agreement was 71.2%, while for *Trachurus mediterraneus* agreement was 69.6%.

Experts mostly confused stages 2 and 3, or 3 and 4 (all mature fish), while trainees also confused stage 1 (immature) and 4 (mature).

The macroscopic maturity stage was validated with the histological analysis after the calibration exercises. For fish with high agreement, the staging was supported by the histological evidence. For specimens with low agreement histology did not support the modal stage. However, during discussions it became obvious that histological criteria for stage 1 and 4 are unclear and there was no agreement between the histological experts. WKMSMAC2 recommends organizing a general histological workshop to establish agreed international histology criteria to identify the macroscopic maturity stages.

For the picture rounds, WebGR was used as a tool. WebGR is an excellent tool for calibration of maturity stagings from pictures. The problem at the moment is that the server where it is based is too slow to handle the number of participants using the tool and the number of pictures stored. WebGR was slow during the first picture round and stopped working during the second picture round. It was also not possible to extract all the results from WebGR needed for the statistical analyses.

The server problems with WebGR do not only increase the workload for chairs immensely, but workshop participants also get frustrated and lose their motivation and do not want to participate in future workshops using WebGR.

Recommendations	Addressed to
1. Develop the WebGR tool. WebGR is developed specifically for age reading workshop and should be updated with maturity staging specific needs (see Section 10).	WGBIOP

2. Usage of the updated international maturity scale to report to ICES (Atlantic) and ACFM (Mediterranean) in Section 4. The scales of the maturity stages reported since 2007 to ICES should be checked.	WGWISE, WGBIOP
3. Organize a new workshop to establish agreed international histology criteria to identify the macroscopic maturity stages. Histology criteria for the macroscopic maturity stages are unclear, it is currently not possible to distinguish between immature (stage 1) and regenerating (stage 4) fish (see also Section 8).	WGBIOP
4. Organize a new maturity staging workshop for mackerel and horse mackerel in 2018 to check the use of the international scale and validate maturity staging.  When pictures are used for calibration of maturity staging, the first round should be carried out before the workshop. The workshop can then start with the discussion of the results and this will allow for more discussion and validation during the workshop itself.	WGBIOP
5. Continue to use fresh/frozen samples and pictures from fresh/frozen samples for maturity workshops where species are studied which are sampled both fresh and frozen. It should however be clearly stated if fish are sampled fresh or frozen, since the appearance of frozen gonads is different from fresh ones.	WGBIOP

**WGBIOP 2016 acknowledges the work done and agrees on scheduling the future workshop to establish agreed international histology criteria to identify the macroscopic maturity stages and the workshop to check the use of the international scale and validate maturity staging in 2018. Also WGBIOP supports the use of both fresh and frozen samples and pictures and the further development of the WebGR tool.**

#### **5.1.8 Workshop on Egg staging, Fecundity and Atresia in Horse mackerel and Mackerel (WKFATHOM)**

The workshop on egg staging, fecundity and atresia in horse mackerel and mackerel (WKFATHOM) was held in Hamburg, Germany, 12–16 October 2015 (to calibrate egg sorting, staging and identification) and Bergen, Norway, 9–12 November 2015 (to calibrate fecundity and atresia estimation and standardize analysis for the DEPM method). The meetings was chaired by Cindy van Damme (the Netherlands), and included 21 participants from nine countries (10 institutes) in the October meeting and 16 participants from 10 countries (11 institutes) in the November meeting.

The ‘spray technique’ for the removal of fish eggs from preserved plankton samples was again tested and shown to inexperienced participants.

The majority of the time at the workshop was spent identifying and staging mackerel, horse mackerel and similar eggs. The results promoted discussion and highlighted specific problem areas. These discussions led to the further development of standard protocols, and enhancements to the species and stage descriptions. The results were very reassuring and similar to those obtained at the 2012 workshop. For the experts there was an underestimate of stage 1 mackerel eggs (stages 1a and 1b combined) during the first round of analysis (-3%) and (-4%) during the second round. The results for stage 1 horse mackerel eggs reduced from an overestimate of 5% to 3% underestimate. This is particularly reassuring as it is at this stage on which the egg production estimates are based.

The pipette sampling for fecundity samples was again shown to the participants. A trial during the workshop showed that all participants take the pipette samples correct as weight of the samples were close to the assumed weight.

The screening, fecundity and atresia calibration proved beneficial to all participants. Agreement in fecundity estimates is very high. For atresia problems occurred which sparked discussion and improved the description of early alpha atresia stages. After discussion, the manual has been improved and there was agreement on identification of vitellogenic and early alpha atretic oocytes.

POF staging remains difficult, but the plenary session on POF staging clarified the POF stages and assessing POF stage for the whole sample.

As the mackerel and horse mackerel egg surveys are carried out once every three years, these workshops are a refresher for expert survey participants and a first acquaintance with new participants in the sample analyses. It should however be realized that two weeks of workshops are not enough to train new participants. Institutes should allow newcomers to be trained properly before the survey.

**WGBIOP 2016 acknowledges the work done.**

#### **5.1.9 Workshop on Growth-increment Chronologies in Marine Fish: climate-ecosystem interactions in the North Atlantic 2 (WKGIC2)**

The workshop on growth-increment chronologies in marine fish: climate-ecosystem interactions in the North Atlantic (WKGIC2) was held in Esporles, Spain, 18–22 April 2016. The meeting was co-chaired by Bryan Black (USA) and Christoph Stransky (Germany), and included 36 participants from 15 countries.

Objectives of this workshop were to i) review the applications of chronologies developed from growth-increment widths in the hard parts (otoliths, shells, scales) of marine fish and bivalve species ii) review the fundamentals of crossdating and chronology development, iii) discuss assumptions and limitations of these approaches, iv) measure otolith growth-increment widths in image analysis software, v) learn software to statistically check increment dating accuracy, vi) generate a growth-increment chronology and relate it to climate indices, and vii) initiate cooperative projects or training exercises to commence after the workshop.

The workshop began with an overview of tree-ring techniques of chronology development, including a hands-on exercise in crossdating. Next, we discussed the applications of fish and bivalve biochronologies and the range of issues that could be addressed. We then reviewed key assumptions and limitations, especially those associated with short-lived species for which there are numerous and extensive otolith archives in European fisheries labs. Next, participants were provided with images of European plaice otoliths from the North Sea and taught to measure increment widths in image analysis software. Upon completion of measurements, techniques of chronology development were discussed and contrasted to those that have been applied for long-lived species. Plaice growth time-series were then related to environmental variability using the KNMI Climate Explorer. Finally, potential future collaborations and funding opportunities were discussed, and there was a clear desire to meet again to compare various statistical techniques for chronology development using a range existing fish, bivalve, and tree growth-increment datasets. Overall, we hope to increase the use of these techniques, and over the long term, develop networks of biochronologies for integrative analyses of ecosystem functioning and relationships to long term climate variability and fishing pressure.

**WGBIOP 2016 acknowledges the work done.**

## 5.2 Exchanges

The following are summaries of the age reading exchanges carried out in 2015 and 2016.

### 5.2.1 Pollack (*Pollachius pollachius*) Exchange 2016

In September 2015, the Working Group on Biological Parameters (WGBIOP) recommended the first otolith exchange for *Pollachius pollachius* in 2016 (Otolith Exchanges proposals for 2016/2017; ICES, 2015). A total of 5 readers from 2 countries (France & Spain) participated at the exchange of 2016. The otoliths of 314 individuals sampled from 2011 to 2015 in Southern stock (ICES area: 9a; n=99) and in (ICES areas: 4c, 7d, 7e, 7j-h; n=215) were used for this exchange. For the Northern stock, the precision values for both stocks were very high but the value for Northern stock (PA=91.6%, CV=3.8%; APE=0.8%) was higher than this for Southern stock (PA=74.5%, CV=14.9%; APE=1.9%). There were some differences between readers but there were no difference between Northern stock readers and between Southern stock readers.

Coordinated by Kélig Mahe (IFREMER, France).

**WGBIOP 2016 acknowledges the work done.**

### 5.2.2 Striped red mullet (*Mullus surmuletus*) and red mullet (*Mullus barbatus*) Exchange 2016

In September 2015, the Working Group on Biological Parameters (WGBIOP) recommended an otolith exchange for *Mullus surmuletus* and *Mullus barbatus* in 2016 (Otolith Exchanges proposals for 2016–2017; ICES, 2015). Two otolith exchanges (2008, 2011), and two age reading workshops (ICES, 2009; 2012), have been taken place until now (Mahé *et al.*, 2012). A total of 13 readers from 5 countries (France, Spain, Italy, Cyprus and Greece) participated at the exchange of 2016. The otoliths of 465 individuals (345 *M. barbatus* & 120 *M. surmuletus*), sampled from 2011 to 2014 in the Mediterranean Sea (Central Adriatic Sea, Cyprus, Levantine Spain coasts, Balearic Islands) were used for this exchange. For both *Mullus* species, the precision values were very low, the PA ranged between 56 and 67% the CV ranged from 32 to 64% and the APE ranged from 1.9 to 3.6%. The results by area and species showed the same trend with the first age groups presenting the higher CV values and in some cases lower PA values. These results could be explained by the position of the first growth increment and the two different approaches of reading interpretation used by the readers (ICES, 2012).

Coordinated by Kélig Mahe (IFREMER, France).

**WGBIOP 2016 acknowledges the work done.**

### 5.2.3 Herring (*Clupea harengus*) Exchange 2015

The current exchange was initiated in 2015 and followed a small calibration exercise where only 3 institutes participated in reading otoliths from the North Sea and Irish Sea areas. It includes samples from the North Sea, Celtic Sea, Irish Sea and 6a (North and South) areas and was completed by 13 readers from 9 institutes. The aim of this combined exchange was to assess the accuracy of the age readings i.e. the proximity of the estimated ages to the modal age which is determined by an index of average percentage error (APE), percentage agreement and relative bias values, and to assess the precision i.e. the reproducibility of age estimates between readers which is determined using the coefficients of variation (CV). In addition, growth curves were com-

piled based on the distance data between annotations made on the otolith images hosted on the online annotation tool, WebGR. The growth curves allow for detailed examination of where the main problems with age interpretation are. Finally, Age Error Matrices were compiled for each area; these provide a measure of accuracy of the age readings and will be provided to HAWG 2016.

For the North Sea area (based on expert readers only) the overall APE is 14.8%. Bias in age estimates were found between the German and Dutch readers who are overestimating the ages in comparison to the modal age. Overall CV was 21.1 % and overall percentage agreement 73.6%.

For the Celtic Sea area (based on expert readers only) the overall APE is 14.2%. Bias in age estimates were found between the German and Dutch readers who are overestimating the ages compared with the modal age and to a lesser extent the Northern Ireland reader who is underestimating the ages compared with the modal age. Overall CV was 19.6 % and overall percentage agreement 75.2%.

For the Irish Sea area (based on expert readers only) the overall APE is 11.6%. Bias in age estimates were found between the German and Dutch readers who are overestimating the ages compared with the modal age and to a lesser extent the Northern Ireland reader and one reader from Norway who are underestimating the ages compared with the modal age. Overall CV was 16 % and overall percentage agreement 77.7%.

For the West of Scotland Sea area (based on expert readers only) the overall APE is 13.6%. Bias in age estimates were found between the German and Dutch readers and to a lesser extent two readers from Norway who are overestimating the ages compared with the modal age. Overall CV was 18.8 % and overall percentage agreement 69.1%.

The combined results show that 3 of the readers (2 of which are experts) are showing significant bias in their age readings. This may be partly due to the differences which arise in age estimates when fish are aged in terms of “rings” vs. “years”. The third reader is repeatedly omitting the first winter ring in the count of age. The age error matrices show that, in most cases, ages are overestimated by more than one year and this indicates that there is more than one ageing problem. The results of the growth curve analyses confirm this but annotation standardization problems are apparent which can confound the results. Bias tests and plots give a more detailed description of reader performance.

Coordinated by Julie Coad Davies (Denmark).

**WGBIOP 2016 acknowledges the work done.**

#### **5.2.4 Sole (*Solea solea*) Exchange 2016**

An international age reading exchange was held for North Sea sole. A total of 16 readers from 19 countries participated in the exchange. Six of the readers (from Germany, Belgium and The Netherlands) supply age determinations that are used in the North Sea sole stock assessment. The other 10 readers (from Denmark, Ireland, Iceland, France, Italy, Portugal) varied in expertise level and in whether or not their age determinations are used in stock assessments (other than North Sea sole).

The exchange was an image-only exchange, run in WebGR from June 2015 to Feb 2016. The exchange set consisted of 160 otoliths from the North Sea, stratified by age,

sex and quarter. The (modal) age range was 0–12. All otoliths were prepared in the same way: neutral-red stained sections.

The consistency was high between the North Sea sole readers: agreement=90%, bias=0.01, CV=3% and APE=2%. The consistency in the whole group was lower, mainly due to the inexperienced readers. A workshop is not considered to be necessary given the overall high agreement, but bilateral tuning is advised for some readers who showed relatively low consistency with the other readers.

Coordinated by Loes Bolle (the Netherlands)

### 5.2.6 Chub mackerel (*Scomber colias*) Exchange 2015

In February 2014, the Working Group on Biological Parameters (WGBIOP) recommended the realization of a first Workshop on Age Reading of Chub Mackerel to discuss the results of a previous exchange. Previous to the Workshop, a small otolith exchange was carried out in March-June 2015. A total of 14 readers from six laboratories of three European countries (Portugal, Spain and Italy) participated in this exchange. The otoliths of 125 individuals sampled in 2011 from ICES areas GSA6; 8c; 9a; were used for this exchange. Overall agreement and precision was low (PA=57.3%, CV=29%), the value for Mediterranean area were slightly better (PA= 62.1%, CV= 35.2%). The results showed 4 groups of readers with different reading criteria. A new otolith exchange was carried out after the identification of age error causes were identified on live screen and an age protocol was created. 14 readers participated in this new exchange. A total of 149 otolith images ICES areas 8c, 9a, CECAF, GSA06, GSA09 and GSA18 were used for this exchange. There has been a small increase in the level of agreement comparing with the previous exchange (PA= 60.6%) and precision decreased (CV= 45.6%) probably due to the elevated number of otoliths with age 0. Some readers that showed bias between them in the previous exchange, showed no bias in this exchange.

Coordinated by Andreia Silva (Portugal) and Maria Rosario Navarro (Spain).

### WGBIOP 2016 acknowledges the work done.

### 5.2.7 Dab (*Limanda limanda*) Exchange 2015

Whole otoliths were aged before the workshop WKARDAB2. Find results under evaluation of the Dab workshop (section 5.1.2)

Coordinated by Loes Bolle (The Netherlands) and Holger Haslob (Germany).

### Informal exchanges

The following informal age reading exchanges were carried out in 2014–2016.

Dab (*Limanda limanda*)

Informal Exchange of Baltic Dab between Denmark and Germany in 2014. Coordinator: Rainer Oberest (Germany)

Norway Pout (*Trisopterus esmarkii*)

Informal Exchange between IMR Norway and Denmark in 2014–2015. Coordinator: Rasmus J. Neilsen (Denmark)

Sandeel (*Ammodytes* spp)



Informal Exchange between IMR Norway and Denmark in 2015. Coordinator: Julie Coad Davies (Denmark)

Herring (*Clupea harengus*)

Informal Exchange of herring in 3a between Sweden and Denmark in 2015. Coordinator: Julie Coad Davies (Denmark)

Herring (*Clupea harengus*)

Informal Exchange of herring in North Sea and Irish Sea between Denmark, Northern Ireland and Scotland in 2015. Coordinator: Julie Coad Davies (Denmark)

Herring (*Clupea harengus*)

Informal WK on Race determination of North Sea herring between Sweden and Denmark in 2016. Coordinator: Lotte Worsøe Clausen and Julie Coad Davies (Denmark)

Cod (*Gadus morhua*)

Informal Exchange of cod in SD22 between Germany and Denmark in 2016. Coordinator: Julie Coad Davies (Denmark)

Pouting (*Trisopterus luscus*)

Informal Exchange between Spain and Portugal in 2016. Coordinator: Sandra Does (Portugal)

## **Annex 6. Draft resolutions for suggested exchanges and workshops**

---

### **Work plan 2016–17**

**The following workshops will take place in 2016. Draft resolutions are available on WGBIOP report 2015 (Annex 5).**

- **WKARSPRAT** A Workshop on Age estimation of Sprat (Co-chairs: Julie Co-ad Davies, Denmark and Claire Moore, Ireland) will meet in Galway (Ireland), 15–18 November 2016
- **WKARWHG2** A Workshop on Age estimation of Whiting [WKARWHG2] (Co-Chairs: Joanne Smith, UK and Lotte Worsøe Clausen, Denmark) will take place in Lowestoft, UK, 22–24 November-2016
- **WKFICON** A Workshop on Fish Condition (Co-Chairs: Josep Lloret, Spain, Claire Saraux, France and Pierluigi Carbonara, Italy) will meet in Girona, Spain in 17–18 November 2016
- **WKARA2** Workshop on Age estimation of European anchovy (Co-Chairs: Andres Uriarte, Spain, Begoña Villamor, Spain and Gualtiero Basilone, Italy) will meet in San Sebastian (Spain), 28 November – 2 December 2016

### **Workshops planned for 2017:**

- **WKAMDEEP2** - A Workshop on Age Estimation Methods of Deep Water Species 2, chaired by Ole Thomas Albert (Norway), Gróa Pétursdóttir (Iceland) and Kélig Mahé (France) will meet in Reykjavik, Iceland, May 2017
- **WKARBLUE2** - A Workshop on Age estimation of Blue Whiting will be established (Co-Chairs: Patrícia Gonçalves from Portugal and Jane A. Godiksen from Norway) and will meet in Lisbon, Portugal, 5–9 June 2017.
- **WKARMAC2** - A Workshop on Age Estimation of Atlantic Mackerel (Chair: Mark Etherton, England), will be established and take place in San Sebastian, Spain, 5–9 January 2017. (DATES ARE LIKELY TO CHANGE TO LATER IN 2017)
- **WKMSHS2** - A Workshop on Sexual Maturity Staging of Herring and Sprat (Co-chairs: Cindy van Damme, The Netherlands and Joanne Smith, UK) will be established and take place in Lysekil, Sweden, 23–27 October 2017.
- **WKVALMU** - A Workshop of Ageing Validation methodology for *Mullus* species will be established (Co-chairs: Kélig Mahé (France), Pierluigi Carbonara (Italy) and Chryssi Mytilineou (Greece) will meet in Monopoli (Italy) in April 2017.
- **WKSEL3** - A Workshop on Elasmobranchs maturity (Co-chairs: Maria Cristina Follesa (Italy) and NN) will be established and will meet in Cagliari (Italy), 25–29 of September 2017.
- **WKMATHIS** - A Workshop on Sexual Maturity staging from histological tools (Co-chairs: Cindy Van Damme (Netherlands) and Maria Cristina Follesa (Italy)) will meet in Caen, France, 19–21 September 2017

### Workshops planned for 2018

- **WKMIAS** - A Workshop on Micro increment daily growth in European Anchovy and Sardine (Chair: Carmen Piñeiro, Spain) will meet at Vigo/Málaga (Spain) in 2018 (exact dates TBC).
- **WKMSMAC3** - A Workshop on Maturity Staging of mackerel (*Scomber scombrus*) and horse mackerel (*Trachurus trachurus*) (WKMSMAC3) (Chairs: TBD) will meet at TBC) in 2018 (exact dates TBC).
- **WKARHOM3** - A Workshop on Age reading of Horse Mackerel, Mediterranean Horse Mackerel and Blue Jack Mackerel (*Trachurus*, *T. mediterraneus* and *T. picturatus*) (Co-chairs: Alba Jurado, (Spain) and Kélig Mahé (France)) will meet in Livorno (Italy), 7–11 May 2018

### Proposal for New Working group

The Workshop on Egg staging, Fecundity and Atresia in Horse mackerel (*Trachurus trachurus*) and Mackerel (*Scomber scombrus*) [WKFATHOM] has met in two years (2012 & 2015) now. The mackerel and horse mackerel egg surveys are carried out triennially. Therefore, this workshop is an essential refresher for experts and invaluable as a training for new participants in the surveys. Considering the need of regular triennial meetings by this group, WGBIOP recommends to create a working group with two-stage meetings every third year, in connection to the international mackerel and horse mackerel egg surveys (WGMEGS)

- **WGFATHOM** – The Workshop on Egg staging, Fecundity and Atresia in Horse mackerel (*Trachurus trachurus*) and Mackerel (*Scomber scombrus*) [WKFATHOM] **will be renamed and instated as** Working group on Egg staging, Fecundity and Atresia in Horse mackerel (*Trachurus trachurus*) and Mackerel (*Scomber scombrus*) [WGFATHOM] chaired by Matthias Kloppmann\*, Germany and Maria Korta\*, Spain will meet twice in autumn 2018 (dates and venues to be decided at the WGMEGS 2017 meeting)

### Otolith exchange:

The following age reading exchanges have been or will be initiated in 2016:

- Otolith Exchange 2016 – Herring (*Clupea harengus*) in Baltic Sea. Coordinator: Jari Raitaniemi (Finland). Ongoing
- Otolith exchange 2016 – Sandeel (*Ammodytes marinus*). Coordinator: Julie Coad Davies (Denmark). Ongoing
- Otolith exchange 2016 – Plaice (*Pleuronectes platessa*) in Baltic Sea. Coordinator: Julie Coad Davies (Denmark). Ongoing
- Otolith exchange 2016 – Sprat (*Sprattus sprattus*) in Celtic Sea, North Sea, Irish Sea, VIa. Coordinator: Julie Coad Davies (Denmark). Ongoing
- Otolith exchange 2016 – Blue whiting (*Micromesistius poutassou*). Coordinators: Patrícia Gonçalves (Portugal) and Jane Godiksen (Norway). Ongoing
- Otolith/scale exchange 2016 – Norwegian Spring-spawning herring (*Clupea harengus*). Coordinator: Jane Godiksen (Norway). Ongoing
- Otolith exchange 2016 – Norway Pout (*Trisopterus esmarkii*). Coordinator: Mark Etherton (UK). To be started soon
- Otolith exchange 2016 – Turbot and Brill (*Scophthalmus maximus* and *Scophthalmus rhombus esmarkii*). Coordinator: Loes Bolle (the Netherlands).

### Otolith Exchanges proposals for 2017/2018

- Otolith exchange 2017 – Sardine (*Sardina pilchardus*) in Areas 7, 8, 9a and Mediterranean. Coordinator: Eduardo Soares (Portugal) and Pedro Torres (Spain). Postponed until 2017.
- Otolith exchange 2017 – Haddock (*Melanogrammus aeglefinus*) from Rockall and North Sea. Communication has been made with Marine Lab Scotland to find a coordinator for this exchange.
- Otolith exchange 2017 – Megrin (*Lepidorhombus spp*). Communication has been made with Marine Lab Scotland to find a coordinator for this exchange.
- Otolith exchange 2017 – chub Mackerel (*Scomber collias*) from Bay of Biscay, Portugal, Mediterranean and Mauritanian waters. Coordinator: Rosario Navarro (Spain) and Andreia V. Silva (Portugal). It will start in March 2017.
- Otolith exchange 2017 – Lemon sole (*Limanda limanda*) from North Sea and 7d. Coordinator: Joanne Smith (UK).
- Otolith exchange 2017/2018 – Dab (*Limanda limanda*) from North Sea and 5a. Coordinators: Holger Haslob (DE) and Loes Bolle (NL). Exchange will address the follow-up actions formulated in the WKARDAB2 report (also see the recommendations in Annex 5, section 5.1.2).

### Draft resolution for Workshops planned in 2017

#### Workshop on Age Estimation Methods of Deep Water Species

A Workshop on Age Estimation Methods of Deep Water Species 2 (WKAMDEEP2), chaired by Gróa Pétursdóttir, Iceland, Kélig Mahé, France will meet at Reykjavik, Iceland, 21-25 August 2017, to:

- Collect and review the consistency of age data used in stock evaluations of deep water fish, including, but not restricted to, tusk (*Brosme brosme*), ling (*Molva molva*), blue ling (*Molva dypterygia*), roundnose grenadier (*Coryphaenoides rupestris*), greater silver smelt (*Argentina silus*), black scabbardfish (*Aphanopus carbo*), black-spotted sea bream (*Pagellus bogaraveo*), greater fork-beard (*Phycis blennoides*) and orange roughy (*Hoplostethus atlanticus*);
- Review new information on precision and accuracy of age estimation of the seven first species listed above, for which WKAMDEEP1 agreed on individual ageing protocols, and revise those protocols as appropriate;
- Review age estimation procedures, and propose new ageing protocols for deep water species not considered by WKAMDEEP1;
- Assemble age reading experts on deep water species for training on age reading of several species, following the recommendation from WKAMDEEP1 to conduct age reading comparisons collectively for the whole group of slow-growing deep water fish;
- Estimate the bias for the long-life species.

#### Supporting Information

Priority:	Essential. Age data are essential in evaluation of fish stocks. Age data are provided by different countries and are estimated using standard ageing criteria. These are generally not fully validated, and regular workshops are
-----------	---

	<p>needed to increase the knowledge base, harmonizing interpretations and estimating precision and relative bias. A basis was established in 2013 by the previous WKAMDEEP.</p> <p>Therefore, a WKAMDEEP-2 should be carried out in order to update the methodology, and evaluate new information on otolith growth and age determination issues for commercially harvested deep water fish species. And as well for the purpose of bringing scattered experts together to develop a coherent approach to age estimation of these typically hard-to-interpret otoliths.</p>
Scientific justification:	<p>The necessity of accurate and precise age data for all species assessed in WGDEEP is massive. The stock-assessment is severely hampered by the lack of valid age-structured data and the fact that the agreement in the age-data supplied to the assessment is very low (as seen in previous exchanges).</p> <p>The aim of the workshop is to establish or update age reading protocols for each species based on recent validation and corroboration studies, and based on these protocols conduct an age reading comparison across labs and for each species in order to increase the reliability of age estimates to be used in stock assessments.</p>
Resource requirements:	No specific resource requirements beyond the need for members to prepare for and participate in the meeting.
Participants:	Participants should include a mixture of scientists and key technicians with expertise in age determination methods, deep water species biology and assessment, as well as data analyses and scientific publication.
Secretariat facilities:	None.
Financial:	Travel costs will be eligible for participants from Member States of the European Union through the EU Data Collection Framework (DCF). Funding for external experts on the age determination methods may be required.
Linkages to advisory committees:	ACOM
Linkages to other committees or groups:	WGDEEP,WGBIOP
Linkages to other organizations:	There is a direct link with the EU DCF.

### **Workshop on Age estimation of Blue Whiting (*Micromesistius poutassou*)**

A **Workshop on Age estimation of Blue Whiting** will be established (Co-Chairs: Patrícia Gonçalves from Portugal and Jane A. Godiksen from Norway) and will meet in Lisbon, Portugal, 5–9 June 2017 to:

- a) Review information on age estimations and validation work done so far;
- b) Analyse the results of exchange programme between ageing labs, using a set of otoliths (images);
- c) Clarify the interpretation of annual rings;
- d) Improve the age reading protocols produced during WKARBLUE1
- e) Present and evaluate the results from age validation studies;
- f) Create a reference collection of agreed age otoliths;
- g) Address the generic ToRs for workshops on age calibration (see WGBIOP Guidelines for Workshops on Age Calibration).

WKARBLUE2 will report by **July 2017** for the attention of ACOM and WGBIOP.

### Supporting Information

<b>PRIORITY:</b>	<p>Age determination is an essential feature in fish stock assessment to estimate the rates of mortalities and growth. In order to arrive at appropriate management advice ageing procedures must be reliable.</p> <p>Otolith processing methods and age reading methods might differ considerably between countries. Therefore, otolith exchanges should be carried out on a regular basis, and if serious problems exist age reading workshops should be organised to solve these problems.</p>
<b>SCIENTIFIC JUSTIFICATION AND RELATION TO ACTION PLAN:</b>	<p>The aim of the workshop is to review the available information on age determination, and validation for blue whiting, to identify the present problems in age determination for this species, improve the accuracy and precision of age determinations and spread information of the methods and procedures used in different ageing laboratories.</p> <p>A number of samples (otoliths or/and images) of otoliths should be circulated among different laboratories to assess the precision of age readers during 2016. Before the workshop, results from the otoliths circulation/exchange will be presented in 2016. Based on the exchange results, in 2016, age validation studies will be established to be conducted by the participants until the workshop. At the workshop, in 2017, results from the exchange and from the age validation studies will be presented and discussed.</p>
<b>RESOURCE REQUIREMENTS:</b>	No specific resource requirements beyond the need for members to prepare for and participate in the exchange and in the meeting.
<b>PARTICIPANTS:</b>	In view of its relevance to the EU Data Collection Framework (DCF), the Workshop is expected to attract interest from ICES Member States.
<b>SECRETARIAT FACILITIES:</b>	None.
<b>FINANCIAL:</b>	Additional funding will be required to facilitate the attendance of the scientists and technicians.
<b>LINKAGES TO ADVISORY COMMITTEES:</b>	ACOM
<b>LINKAGES TO OTHER COMMITTEES OR GROUPS:</b>	WGWIDE, WGBIOP, ACOM, RCMs, all WKACs (Age Calibration Workshops)
<b>LINKAGES TO OTHER ORGANISATIONS:</b>	There is a direct link with the EU DCF

### Workshop on Age estimation of Mackerel (*Scomber scombrus*) (WKARMAC2)

A **Workshop on Age Estimation of Atlantic Mackerel** (Chair: Mark Etherton, England), will be established and take place in San Sebastian, Spain, 5–9 January 2017 (dates likely to be postponed to later in 2017) to:

- a) Review information on age estimations, recent otolith exchanges, the previous workshop in 2010 (WKARMAC) and validation work done so far.
- b) Report on ageing protocols currently in use and improve on them where possible.
- c) Address the low agreement between readers of this species, particularly in fish over the age of 6 years with group exercises and reading sample sets.
- d) Create a reference collection of agreed age otoliths.
- e) Address the generic ToRs adopted for workshops on age calibration (see ['WGBIOP Guidelines for Workshops on Age Calibration'](#))

WKARMAC2 will report by February 2017 for attention to ACOM.

#### Supporting information:

Priority:	Essential. Age determination is an essential feature in fish stock assessment to estimate the rates of mortalities and growth. In order to arrive at appropriate management advice ageing procedures must be reliable. Otolith processing methods and age reading methods might differ considerably between countries. Therefore, otolith exchanges should be carried out on a regular basis, and if serious problems exist age reading workshops should be organised to solve these problems.
Scientific justification:	To identify the present problems in age determination for this species, improve the accuracy and precision of age determinations and spread information of the methods and procedures used in different ageing laboratories.
Resource requirements:	Institutes to supply otolith samples for potential inclusion in a reference set.
Participants::	The Workshop will include international experts on growth and age estimation In view of its relevance to the EU Data Collection Framework (DCF), the Workshop is expected to attract interest from ICES Member States.
Secretariat facilities:	None
Financial:	None
Linkages to advisory committee:	ACOM
Linkages to other committees or groups:	WGBIOP, ACOM, RCM, all WKACs (Age Calibration Workshops)
Linkages to other organizations cost:	There is a direct link with the EU DCF

### A Workshop on Sexual Maturity Staging of Herring and Sprat

A **Workshop on Sexual Maturity Staging of Herring and Sprat** (Co-chairs: Cindy van Damme, The Netherlands and Joanne Smith, UK) will be established and take place in Lysekil, Sweden, 23–27 October 2017 to:

- a) Report on the use of the 2011 proposed common scale;
- b) Check the description of the characteristics of the stages of the 2011 scale and create a new validated scale if necessary;
- c) Calibrate staging of herring and sprat using fresh fish;
- d) Calibrate staging of herring and sprat using photographs, following the pattern of trial-discussion-retrial;
- e) Validate macroscopic maturity determination with histological analysis
- f) Address the generic ToRs adopted for maturity staging workshops (see 'WGBIOP Guidelines for Workshops on Maturity Staging').

WKMSHS2 will report by **December 2017** for the attention of ACOM and WGBIOP.

### Supporting Information

Priority:	The maturity stage is an important biological parameter to be used in the calculation of maturity ogives (and therefore of Spawning-stock biomass), for the definition of the spawning season of a species, for the monitoring of long term changes in the spawning cycle, and for many other research needs regarding the biology of fish. Moreover all these parameters are essential input data for the model of fish stocks-assessment usually used to establishing a diagnosis on stock status.
Scientific justification and relation to action plan:	During the 2011 workshop a common maturity scale with objective common criteria was proposed for herring and sprat. Laboratories involved in collection maturity data agreed to use the common scale for reporting. This workshop has the objective of reaching an agreement on a common scale to be used, but also to define objective criteria to classify the maturity stages of that scale. The expectation of TOR a) has the goal of measuring the usefulness of the 2011 maturity scale and the conversion with the different scale used in the different lab/institute. TOR b) to validate the criteria and descriptions to classify maturity stages of the 2011 scale which takes into account the difficulties and / or inconsistencies of the maturity scales in use in different lab. TOR c and d) calibrate maturity staging between the different laboratories. TOR e) validate with histological analysis the macroscopic maturity stage, mainly the resting stages that are incorrectly classified as immature. It is recommended that the Workshop be organised in March 2017. Participating institutes will be able to collect samples during 2016.
Resource requirements:	Before the Workshop the chairs will setup a sampling plan for collecting samples for to be used during workshop. The sampling will be carried out during 2016. For all species, the sampling parameters are: total length; gonad visual inspection - maturity stage by the new common maturity scale; total weight; gonad weight; liver weight; gutted weight; gonad photo; age; histological maturity stage; microscopic preparation photo. This workshop will be based on the analysis of both digital photos of gonads and fresh gonads. Therefore facilities suitable to examine fresh biological material must be available during the workshop. It would be necessary to have a web server for storage and easy access to the photos collected by the participants before the workshop.
Participants:	In view of its relevance to the EU Data Collection Framework (DCF), the Workshop is expected to attract interest from ICES Member States.
Secretariat facilities:	None.



Financial:	Additional funding will be required for facilitate the attendance of the scientists and technicians.
Linkages to advisory committees:	ACOM
Linkages to other committees or groups:	WGBIOP, ACOM, RCM, all WKMSs (Maturity Staging Workshops), HAWG, WGIPS, IBTSWG
Linkages to other organisations:	There is a direct link with the EU DCF

### A Workshop on Ageing Validation methodology of *Mullus* species

A Workshop on Ageing Validation methodology of *Mullus* species [WKVAL-MU] will be established (Kélig Mahé, France; Pierluigi Carbonara, Italy; Chryssi Mytilineou, Greece) and will meet at Monopoli, Italy in April 2017 to:

- a) Analyse the results of past exchanges and workshops;
- b) Review the age validation methods (direct, indirect and semi-direct) and their applicability on the *Mullus* species;
- c) Examples of morphological and morphometric analysis in the context of the age validation;
- d) Multi-parameters analysis on datasets with different ageing schemes/criteria (birthday, number check before the first winter ring, preparation method);

WKVALMU will report by **July 2017** for the attention of ACOM and WGBIOP.

### Supporting Information

Priority:	<p>The age and growth (growth parameters, ALK) are essential input data for the models usually used in fish stock-assessment, mainly for the analytic ones, to establish a diagnosis on stock status,.. Many of the uncertainty on the stock evaluation could come from to the inconsistency on ageing analysis (otolith reading). In the last years, three exchanges and two workshops have been organized on the ageing calibration (ICES, 2009; ICES, 2012; Mahè <i>et al.</i>, 2011; Mahè <i>et al.</i>, 2016) of <i>Mullus barbatus</i> and <i>Mullus surmuletus</i> without substantial improvement of the age precision index (% agreement, CV and APE). The most important problems that affect the accuracy and precision are:</p> <ul style="list-style-type: none"> <li>• Identification of the first winter ring;</li> <li>• Different ageing schemes;</li> <li>• Ring overlapping in oldest specimens.</li> </ul> <p>The stock assessment groups for <i>Mullus</i> species continue to use the age data until now; however, without a substantial improvement on the ageing quality it would be better stop using the age data (otolith reading) as the input data for the stock assessment.</p>
Scientific justification and relation to action plan:	<p>This workshop will provide the opportunity for the ICES/GFCM community working on:</p> <ul style="list-style-type: none"> <li>• age validation methodology more appropriate to the <i>Mullus</i> species;</li> <li>• statistically evaluate the influence of the ageing protocol on the age data as well as effect of ageing scheme, ageing criteria preparation method, birthday used etc.</li> </ul> <p>The workshop will provide an arena to discuss how it could help to overcome the uncertainty of otolith reading. The workshop will be based on the practical example on the application of the age validation methodology for the <i>Mullus</i> species.</p>
Resource	To ensure wide attendance of relevant experts, additional funding will be

requirements:	required, preferably through the EU, e.g. by making attendance to the Workshop eligible under the DCR.
Participants:	In view of its relevance to the EU Data Collection Framework (DCF), the Workshop is expected to attract interest from ICES / GFCM Member States.
Secretariat facilities:	ICES secretary
Financial:	Additional funding will be required for facilitate the attendance of the scientists and technicians.
Linkages to advisory committees:	ACOM
Linkages to other committees or groups:	Outcomes from this Workshop will be of interest to all Assessment Working Group related to Mullus species. Moreover WGBIOP, ACOM, RCM, and scientific trawl survey working group like the IBTSWG, and WGMEGS and MEDITSWG.
Linkages to other organisations:	There is a direct link with the EU DCF

### Workshop on Elasmobranchs maturity

A **Workshop on Elasmobranchs maturity** [WKSEL3] will be established (Maria Cristina Follesa Italy; Pierluigi Carbonara, Italy) and will meet in Cagliari (Italy), 25–29 of September 2017 to:

- a) Update the international maturity scales based on macroscopic features both for oviparous and viviparous species
- b) validate both maturity scales based on macroscopic features through histological analysis
- c) Update the conversion tables both for oviparous and viviparous species;
- d) Compile an Atlas using both macroscopical and histological gonad pictures
- e) Increase the number of case studies with particular attention for viviparous species

WKSEL3 will report by **December 2017** for the attention of ACOM and WGBIOP.

### Supporting Information

Priority:	<p>According to the most recent data of the IUCN red list, a quarter of the world's sharks and rays are threatened and more are considered to become extinct in the near future, with ray species found to be at a higher risk than sharks. Close to 40% of the species are classified as Data Deficient.</p> <p>In the last years, worldwide chondrichthyan fisheries have expanded in response to growing demand and the utilization of more technically equipped fishing vessels. These developments, together with the decline in several elasmobranch stocks, have led to a call for an improvement in international actions for the management of sharks and related species to ensure sustainable elasmobranch fisheries. One of the most important parameters used in stock assessment is the maturity of a species. The maturity is used in the calculation of maturity ogives (and therefore of Spawning-stock biomass), for defining the spawning season of a species, for monitoring long term changes in spawning cycle, and for many other research needs related to the biology of fish.</p>
Scientific justification and relation to action plan:	<p>This workshop will provide the opportunity to regroup the ICES/GFCM community working on this field. During the 2012 WGSEL2 workshop a common maturity scale with objective of common criteria was proposed both for oviparous and viviparous elasmobranchs species. Laboratories involved in the collection of maturity data agreed to</p>

	<p>use the common scale for reporting.</p> <p>This new workshop (WGSEL3) has the objective of updating the common scales to be used, but also to define new objective criteria to classify the maturity stages in those scales.</p> <p>The expectations of TORs are:</p> <ol style="list-style-type: none"> <li>a) Update the international maturity scales based on macroscopic features both for oviparous and viviparous species</li> <li>b) validate both maturity scales based on macroscopic features through histological analysis</li> <li>c) Update the conversion tables both for oviparous and viviparous species;</li> <li>d) Compile an Atlas using both macroscopical and histological gonad pictures</li> <li>e) Increase the number of case studies with particular attention for viviparous species</li> </ol>
Resource requirements:	<p>Before the Workshop, the chairs will setup a plan for collecting samples to be used during the workshop.</p> <p>For all species, the sampling parameters to be recorded are: total length; gonad visual inspection - maturity stage using the new common maturity scale; total weight; gonad weight; liver weight; gutted weight; gonad photo; age; histological maturity stage; histological photos.</p> <p>This workshop will be based on the analysis of both digital photos of gonads and fresh gonads. Therefore facilities suitable to examine fresh biological material must be available during the workshop. It would be necessary to have a web server for storage and easy access to the photos collected by the participants before the workshop.</p>
Participants:	In view of its relevance to the DCF, the Workshop is expected to attract wide interest from ICES Member States and Mediterranean countries participating in biological sampling of Elasmobranches species. Participants should include a mixture of scientists and technicians with expertise in maturity staging, biology and stock assessment of fish.
Secretariat facilities:	ICES
Financial:	<p>To obtain all biological data before the Workshop, funding is needed for buying fresh ungutted fish and for processing gonads histology.</p> <p>To ensure wide attendance of relevant experts, additional funding will be required, preferably through the EU, e.g. by making attendance to the Workshop eligible under the DCF</p>
Linkages to advisory committees:	ACOM/WGBIOP
Linkages to other committees or groups:	This workshop is proposed by WGBIOP. Outcomes from this Workshop will be of interest to all Working and Study Groups working on assessment as well as to survey groups like the IBTSWG, WGMEGS, WGEF and MEDITS-WG.
Linkages to other organisations:	There is a direct link with the EU DCF.

### Workshop on Sexual Maturity staging from histological tools

A **Workshop on Sexual Maturity staging from histological tools** (WKMATHIS), chaired by Cindy Van Damme, The Netherlands and Maria Cristina Follesa, Italy, will meet in Caen, France, 19-21 September 2017 to:

- a) Review the histological studies applied to validate macroscopic stages,
- b) Explore the classification criteria and prepare an international description of histological criteria to validate macroscopic maturity stages;

- c) Identify the limits of macroscopic staging for the use of gonadal development studies
- d) Identify the needs for histological studies to improve the quality of the macroscopic maturity staging.

### Supporting Information

Priority:	Macroscopic stages of gonadal development are an essential feature in fish stock assessment to estimate the maturity ogive and Spawning-stock biomass (SSB). Past maturity staging wk's have brought to light that there is no international agreement on the use of histological criteria to validate macroscopic maturity staging. Limits of the maturity stages are difficult to identify. Consequently, these data provided by different countries present a large bias. Therefore, a WK should be carried out in order to make a general review of the histological studies applied to macroscopic stages, compile international agreed histological descriptions for the different maturity stages, compile an overview of available histological information and to identify the need for further studies on histological tools to validate the macroscopic stages of gonadal development.
Scientific justification:	<p>The necessity to clarify the ogive of maturity is identified during a lot of benchmarks and stocks assessments groups. When the macroscopic stages of maturity are not clearly identifiable, the histological studies are necessary to help to increase the precision of these data.</p> <p>The aim of the workshop is to identify the state of art of histological studies to applied to sexual maturity staging, compile an international agreed histological descriptions of maturity stages and to identify the need for further studies on histological tools to validate the macroscopic stages of gonadal development.</p>
Resource requirements:	No specific resource requirements beyond the need for members to prepare for and participate in the meeting.
Participants:	Participants should include a mixture of scientists and key technicians with expertise in macroscopic stages of gonadal development and histological methods, as well as stock assessment.
Secretariat facilities:	None.
Financial:	Travel costs will be eligible for participants from Member States of the European Union through the EU Data Collection MAP (DCMAP). Funding for external experts on the age determination methods may be required.
Linkages to advisory committees:	ACOM
Linkages to other committees or groups:	WGBIOP
Linkages to other organizations:	There is a direct link with the EU DCF.

## Workshops proposal 2018

### A Workshop on Micro increment daily growth in European Anchovy (*Engraulis encrasicolus*) and Sardine (*Sardina pilchardus*) (WKMIAS)

A Workshop on Micro increment daily growth in European Anchovy and Sardine (Chairs: Carmen Piñeiro, Spain and TBD) will meet at Vigo/Málaga (Spain) in October–November 2018 to:

- a) Review validation of daily ring formation;
- b) Define and standardize the daily age reading criteria among areas;
- c) Validate the first annulus in young of the year anchovy and sardine in different areas;
- d) Estimate precision and accuracy of age estimates by micro-increment counts;
- e) Improve the reference collection of otoliths created in the WKMIAS and start new collection of age known otoliths images;
- f) Evaluate the reliability of new age assignment techniques (i.e. estimation of age by discriminant functions analysis).

WKMIAS will report by TBD 2018 to the attention of ACOM, and WGBIOP

### Supporting information

Priority:	The current activities of this Group will lead ICES into issues related to the ecosystem affects of fisheries, especially with regard to the application of the Precautionary Approach. Consequently, these activities are considered to have a very high priority.
Scientific justification and relation to action plan:	Based on main results produced in previous ICES workshops and Exchanges on ageing adult anchovy and sardine (WKARA 2009, WKARAS 2011, Anchovy Exchange 2014), a focal point was to correctly identify the right position of the first ring (annulus) on sagittal otoliths of these species, being one of the main sources of error affecting ageing precision. Improving precision in age reading is extremely important in general, even more in short-lived species such as anchovy and sardine. One of the most common method to validate the timing and position of the first ring consists of counting of otolith microincrements (daily rings) in juveniles (young-of-the-year). Daily growth studies of anchovy and sardine are currently carried out in different European laboratories, principally to analyse the effects of environmental parameters on growth and survival, and thus to understand the factors affecting recruitment processes of these species. However, given the wide span of methodologies already existing within laboratories, ageing data are often difficult to compare, actually masking the contribute of environmental conditions of different growth rate patterns observed among areas. The aim of the workshop is to collate these different protocols as starting point to produce single validated protocol to better standardize age estimates, either on daily or annual basis.
Resource requirements:	The research programmes which provide the main input to this group are already underway, and resources are already committed. The additional resource required to undertake additional activities in the framework of this group is negligible.
Participants:	The Group is normally attended by some 20–25 members and guests.
Secretariat facilities:	None.

Financial:	
Linkages to advisory committee:	ACOM
Linkages to other committees or groups:	WGBIOP, WGHANSA,
Linkages to other organizations cost:	There is a direct link with the EU DCF
Secretariat marginal cost share:	

### Workshop on Age reading of Horse Mackerel, Mediterranean Horse Mackerel and Blue Jack Mackerel

A Workshop on Age reading of Horse Mackerel, Mediterranean Horse Mackerel and Blue Jack Mackerel (*Trachurus*, *T. mediterraneus* and *T. picturatus*), chaired by Alba Jurado, Spain and Kélig Mahé, France, will be held in Livorno (Italy), 7–11 May 2018, to:

- a) Review information on age determination, otolith exchanges and validation study on these species
- b) Clarify the position of the first annulus with the images analysis for three species
- c) Evaluate the effect of different schemes of ageing particularly the date of birth for *Trachurus mediterraneus*
- d) Continue the guidelines and common ageing criteria;
- e) Develop existing reference collections of otoliths;
- f) Address the generic ToRs adopted for workshops on age calibration (see 'PGCCDBS Guidelines for Workshops on Age Calibration').

### Supporting Information

Priority:		Essential. Age determination is an essential feature in fish stock assessment to estimate the rates of mortalities and growth. Age data are provided by different countries and are estimated using international ageing criteria. It is necessary to continue to clarify this guideline of age interpretation. Therefore, an appropriate otolith exchange programme will be carried out in 2017 for the purpose of inter-calibration between ageing labs. Results of this otolith exchange will be discussed during WKARHOM3.
Scientific justification and relation to action plan:		The aim of the workshop is to identify the current ageing problems between readers and standardize the age reading procedures in order to

		improve the accuracy and precision in the age reading of this species.
Resource requirements:		No specific resource requirement beyond the need for members to prepare for and participate in the meeting.
Participants:		In view of its relevance to the DCF, and ICES WG, the Workshop try to join international experts on growth, age estimation and scientists involved in assessment in order to progress towards a solution. Participants should announce their intention to participate in the WK no later than two months before the meeting.
Secretariat facilities:		None
Financial:		
Linkages to advisory committees:		ACOM/WGBIOP
Linkages to other committees or groups:		WGBIOP
Linkages to other organisations:		There is a direct link with the EU DCF.

### **Draft resolution for the new proposed Working group**

#### **Workshop on Egg staging, Fecundity and Atresia in Horse mackerel**

A **Workshop on Egg staging, Fecundity and Atresia in Horse mackerel** (*Trachurus trachurus*) and Mackerel (*Scomber scombrus*) chaired by Matthias Kloppmann\*, Germany and Maria Korta\*, Spain will meet twice in autumn 2018 (dates and venues to be decided at the WGMEGS 2017 meeting) to:

- a) carry out comparative plankton sorting trials on typical survey samples. This should follow the pattern of trial – analysis – retrieval – identification of problem areas;
- b) carry out a comparative egg staging trial for mackerel and horse mackerel eggs following the pattern used in the 2015 egg staging workshop;
- c) update a set of standard pictures and descriptions for species identification and egg staging;
- d) provide a review of any available documentation on identifying eggs to species and define standard protocols;
- e) carry out inter-calibration work on fecundity determination and harmonize the analysis and interpretation of fecundity samples;

**WKFATHOM 3 will report by 1 January 2019 to the attention of SCICOM, WGMEGS and WGBIOP.**

### Supporting Information

Priority:	Information quality, used to provide fisheries advice through WGWIDE, will be impaired if this workshop is not conducted.
Scientific justification and relation to action plan:	<p>Sorting eggs from plankton samples, Identification of eggs to species and the staging of those eggs remains one of the key areas in the execution of the mackerel and horse mackerel egg surveys. As this process is carried out by a number of different operators in many different countries, and then the data combined, it is vital that the process be standardized. WGMHSA and WGMEGS strongly feel that this is best done through the mechanism of sample exchange programmes and regular workshops to compare results. In the context of the triennial egg surveys it would seem appropriate to hold a workshop prior to every survey to standardize approaches and methodologies in the run-up to the surveys. This will have the advantage of training new operators as well as harmonizing the approach of experienced operators. Egg staging workshops were held in 2000, 2003 and 2006 and were very successful in achieving these aims. It is proposed that these be used as a model for the proposed workshop in 2009. It is expected that the workshop will use the proven method of carrying out a set of sorting trials, analysing the results and identifying problems, and then repeating the trials on the basis of the new understanding.</p> <p>The workshop will also be tasked to update a standard manual of descriptions and photographs to assist in the plankton sample handling procedure. This material was assembled into an agreed standard manual at previous workshops.</p> <p>In the context of these surveys, fecundity estimation is very important for conversion of egg production to biomass. Fecundity estimation is carried out using histological methods, and the analysis and interpretation of this material also requires standardization across participating institutes. Standardization of this aspect of the work will be included in the workshop.</p> <p>Goal 1. Understand the physical, chemical, and biological functioning of marine ecosystems</p> <p>Modernise technologies and sampling designs for collecting, measuring, and enumerating marine organisms, and improve the precision and accuracy of resource surveys.</p> <p>Goal 4. Advise on the sustainable use of living marine resources and protection of the marine environment</p> <p>Develop quality assurance protocols to enhance confidence in scientific advice.</p>
Resource requirements:	None
Participants:	Mainly scientists (approximately 20) involved in the surveys.
Secretariat facilities:	None
Financial:	No financial implications
Linkages to advisory committees:	ACOM
Linkages to other committees or groups:	WGMEGS, WGWIDE, WGALES and WGBIOP
Linkages to other organisations:	None



## Annex 7. Past workshops and exchanges and other workshops with relevance for biological parameters

SPECIES	FISH STOCK	NAME	2017	2016	2015	2014	2013	2012	2011	2010	2009	2008	2007	2006	2005	2004	2003	2002	2001	2000	1999	1998	1997	1996	1995	1994	1993	1992	1991		
Melanogrammus aeglefinus	had-act	Haddock in Subarea I and II (Northeast Arctic)								ex PGCCDBS 2010_p41																					
	had-scw	Haddock in Division VIa (West of Scotland)								ex PGCCDBS 2010_p41																					
	had-34	Haddock in Subarea IV (North Sea) and Division IIIa West (Skagerrak)	Exchange Coordinators to be decided				WIK21702 Workshop on age estimation of haddock in the North Sea, 20-21 October 2013, Copenhagen, Denmark	WIK21703 Workshop on age estimation of haddock in the North Sea, 22-23 October 2013, Copenhagen, Denmark																							
	had-6ro	Haddock in Division VIb (Icelandic haddock)																													
	had-icg	Haddock in Division Va (Icelandic haddock)																													
	had-7b-k	Haddock in Divisions VIIb-k (Irish Sea)																													
	had-7b-l	Haddock in Division VIIb (Irish Sea)																													
had-rock	Haddock in Division VIb (Rockall)	Exchange Coordinators to be decided																													
Salmo salar	sal-na	Salmon in the North-American	Exchange ??						WIKARBI Workshop on age estimation of Atlantic salmon, 20-21 October 2011, Copenhagen, Denmark																						
	sal-nea	Salmon in the North-east Atlantic																													
	sal-wg	Salmon in West Greenland																													
	sal-2431	Salmon in Subdivisions 22-31 (Main Barents and Gulf of Barents)																													
	sal-32	Salmon in Subdivision 32 (Gulf of Finland)										SGSAD Dissolved 2009			SGSAD				SG	SG										WK Report of	
her-3a22	Herring in Division IIIa and Subdivisions 22-24 (Baltic Sea)																														
her-2532-gr	Herring in Subdivisions 25-29 (excluding Gulf of Riga)																														
her-30	Herring in Subdivision 30 (Bothnian Sea)										WIKARBI Dissolved 2009																				
her-31	Herring in Subdivision 31 (Bothnian Bay)																														
her-riga	Herring in Subdivision 28.1 (Gulf of Riga)																														
her-433	Herring in Subarea IV and Divisions IIIa and VIa (North Sea autumn spawners)																														
her-IIIc	Herring in Division IIIc (North Sea)																														
her-IIIa	Herring in Divisions IIIa (South) and IIIb (North)																														
her-IIIb	Herring in Division IIIb (North Sea)																														
her-IIIc	Herring in Division IIIc (North Sea)																														
her-IIIa	Herring in Division IIIa (North Sea)																														
her-IIIb	Herring in Division IIIb (North Sea)																														
her-IIIc	Herring in Division IIIc (North Sea)																														
her-IIIa	Herring in Division IIIa (North Sea)																														
her-IIIb	Herring in Division IIIb (North Sea)																														
her-IIIc	Herring in Division IIIc (North Sea)																														
her-IIIa	Herring in Division IIIa (North Sea)																														
her-IIIb	Herring in Division IIIb (North Sea)																														
her-IIIc	Herring in Division IIIc (North Sea)																														
her-IIIa	Herring in Division IIIa (North Sea)																														
her-IIIb	Herring in Division IIIb (North Sea)																														
her-IIIc	Herring in Division IIIc (North Sea)																														
her-IIIa	Herring in Division IIIa (North Sea)																														
her-IIIb	Herring in Division IIIb (North Sea)																														
her-IIIc	Herring in Division IIIc (North Sea)																														
her-IIIa	Herring in Division IIIa (North Sea)																														
her-IIIb	Herring in Division IIIb (North Sea)																														
her-IIIc	Herring in Division IIIc (North Sea)																														
her-IIIa	Herring in Division IIIa (North Sea)																														
her-IIIb	Herring in Division IIIb (North Sea)																														
her-IIIc	Herring in Division IIIc (North Sea)																														
her-IIIa	Herring in Division IIIa (North Sea)																														
her-IIIb	Herring in Division IIIb (North Sea)																														
her-IIIc	Herring in Division IIIc (North Sea)																														
her-IIIa	Herring in Division IIIa (North Sea)																														
her-IIIb	Herring in Division IIIb (North Sea)																														
her-IIIc	Herring in Division IIIc (North Sea)																														
her-IIIa	Herring in Division IIIa (North Sea)																														
her-IIIb	Herring in Division IIIb (North Sea)																														
her-IIIc	Herring in Division IIIc (North Sea)																														
her-IIIa	Herring in Division IIIa (North Sea)																														
her-IIIb	Herring in Division IIIb (North Sea)																														
her-IIIc	Herring in Division IIIc (North Sea)																														
her-IIIa	Herring in Division IIIa (North Sea)																														
her-IIIb	Herring in Division IIIb (North Sea)																														
her-IIIc	Herring in Division IIIc (North Sea)																														
her-IIIa	Herring in Division IIIa (North Sea)																														
her-IIIb	Herring in Division IIIb (North Sea)																														
her-IIIc	Herring in Division IIIc (North Sea)																														
her-IIIa	Herring in Division IIIa (North Sea)																														
her-IIIb	Herring in Division IIIb (North Sea)																														
her-IIIc	Herring in Division IIIc (North Sea)																														
her-IIIa	Herring in Division IIIa (North Sea)																														
her-IIIb	Herring in Division IIIb (North Sea)																														













## Annex 8 Suggested changes to the recommendation system

---

### Guidelines for chairs for filling in the ICES recommendations database

#### FIELD 1 to 9 is to be filled in by the chair of the requesting group

- 1) **EG (Expert Group) is the requesting group** that brings up a problem and that formulates a recommendation. Use the dropdown box for selecting the correct group.
- 2) **Year** of the recommendation.
- 3) **Contact person** is the person responsible for the follow-up of the recommendation or the person in charge for this recommendation in the requesting group.
- 4) **Recommendation category:** use the drop down box to choose the correct category.
- 5) **Species:** use the dropdown box to choose the correct species.
- 6) **Stock:** use the dropdown box to choose the correct stock.
- 7) **Background for recommendation** identifies the problem, clarifies the features and possible consequences of it.
- 8) **Recommendation** suggests what should be done or how should be proceeded to solve the problem. The recommendation needs to be precise enough to be fulfilled, clear and unambiguous. Be sure that words relating to 'improvement of quality' match the language used in EC/CDMAP in order to be 'understood'.
- 9) **Recipient** is an expert group (e.g. WGBIOP) or another organ that suggests further actions to solve the described problem. Use the dropdown box to choose the correct Recipient.

#### FIELD 10 and 11 is to be filled in by the ICES secretariat

- 10) **Version history**
- 11) **Status**

#### FIELD 12 to 15 is to be filled in by the recipient group

- 12) **Final Recipient Action** describes the actions that were undertaken by the recipient group to meet the expectations of the requesting group.
- 13) **Responsible person** in the recipient (group). This is the person that was indicated within the recipient group to answer to the recommendation and that communicates that the recommendation was answered.
- 14) **Date** of the recipient group chair filling in the final status into the database.
- 15) **Final status** choose the correct status from the dropdown box.



## Species Stock list and recommendation category possibilities for Integration of the template from 2015 into the ICES template

SPECIES	STOCK	NEW POSSIBILITIES FOR RECOMMENDATION CATEGORY FIELD
Albacore ( <i>Thunnus alalunga</i> )	Arctic	Biological parameters (age, maturity, other)
American Plaice ( <i>Hippoglossoides platessoides</i> )	Baltic	Abiotic parameters (temperature, nutrient concentration, other)
Anchovy ( <i>Engraulis encrasicolus</i> )	GSA 10	Software
Anglerfish ( <i>Lophius piscatorius</i> )	GSA 11	Others
Antarctic Toothfish ( <i>Dissostichus mawsoni</i> )	GSA 16	
Atlantic Bluefin Tuna ( <i>Thunnus thynnus</i> )	GSA 16	
Atlantic Bonito ( <i>Sarda sarda</i> )	GSA 17	
Ballan Wrasse ( <i>Labrus bergylta</i> )	GSA 18	
Beaked Redfish ( <i>Sebastes mentella</i> )	GSA 19	
Beryx ( <i>Beryx decadactylus</i> )	GSA 9	
Bib ( <i>Trisopterus luscus</i> )	Gulf of Lion	
Black Scabbard Fish ( <i>Aphanopus carbo</i> )	Gulf of Riga	
Blackbelly Rosefish ( <i>Helicolenus dactylopterus</i> )	ICCAT	
Blue Ling ( <i>Molva dypterygia</i> )	Mediterranean	
Blue Shark ( <i>Prionace glauca</i> )	1	
Blue Whiting ( <i>Micromesistius poutassou</i> )	1	
Boarfish ( <i>Capros aper</i> )	3	
Bogue ( <i>Boops boops</i> )	3a	
Brill ( <i>Scophthalmus rhombus</i> )	3a,b	
Capelin ( <i>Mallotus villosus</i> )	3b	
Catfish (-)	3c	
Cephalopods (-)	3c,d	
Chilean Jack Mackerel ( <i>Trachurus murphyi</i> )	3d	
Cod ( <i>Gadus morhua</i> )	4	
Common Pandora ( <i>Pagellus erythrinus</i> )	5	
Common Two-Banded Sea bream ( <i>Diplodus vulgaris</i> )	6	
Conger Eel ( <i>Conger conger</i> )	V7	
Cyprinids (Cyprinidae)	7a	
Deep water Species (-)	7b-k	
Dolphinfish ( <i>Coryphaena hippurus</i> )	7c	
Eel ( <i>Anguilla anguilla</i> )	7d	
Eelpout ( <i>Zoarces viviparus</i> )	7e	

Elasmobranchs (-)	7f
Flatfishes (-)	7g
Flounder ( <i>Platichthys flesus</i> )	7h
Four-Spot Megrin ( <i>Lepidorhombus boscii</i> )	8
Greater Argentine ( <i>Argentina silus</i> )	8a
Greater Forkbeard ( <i>Phycis bleimoides</i> )	8a,b
Greenland Halibut ( <i>Reinhardtius hippoglossoides</i> )	8b
Grenadiers (-)	8c,d
Grey Gurnard ( <i>Eutrigla gurnardus</i> )	8d
Gulper Shark ( <i>Centrophorus granulosus</i> )	8e
Gurnards (-)	8k
Haddock ( <i>Melanogrammus aeglefinus</i> )	9
Hake ( <i>Merluccius merluccius</i> )	14
Halibut ( <i>Hippoglossus hippoglossus</i> )	
Herring ( <i>Clupea harengus</i> )	
Horse Mackerel ( <i>Trachurus trachurus</i> )	
Lemon Sole ( <i>Microstomus kitt</i> )	
Leopardfish (-)	
Ling ( <i>Molva molva</i> )	
Longnose Spurdog ( <i>Squalus blainvillei</i> )	
Lumpsucker ( <i>Cyclopterus lumpus</i> )	
Mackerel ( <i>Scomber scombrus</i> )	
Mackerels ( <i>Scomber spp</i> )	
Mediterranean Horse Mackerel ( <i>Trachurus mediterraneus</i> )	
Megrin ( <i>Lepidorhombus whiffiagonis</i> )	
Monkfishes ( <i>Lophius spp</i> )	
Norway Pout ( <i>Trisopterus esmarkii</i> )	
Patagonian Toothfish ( <i>Dissostichus eleginoides</i> )	
Pelagic Species (-)	
Pelagic Stingray ( <i>Pteroplatytrygon violacea</i> )	
Perch ( <i>Perca fluviatilis</i> )	
Picarel ( <i>Spicara smaris</i> )	
Pike ( <i>Esox lucius</i> )	
Pike-Perch (Zander) ( <i>Sander lucioperca</i> )	
Plaice ( <i>Pleuronectes platessa</i> )	
Polar Cod ( <i>Boreogadus saida</i> )	
Pollack ( <i>Pollachius virens</i> )	
Portuguese Dogfish ( <i>Centroscymnus coelolepis</i> )	
Pouting ( <i>Trisopterus spp</i> )	
Red Gurnard ( <i>Chelidonichthys cuculus</i> )	
Red Mullet ( <i>Mullus surmuletus</i> )	
Red Pandora ( <i>Pagellus bellottii</i> )	
Red sea bream ( <i>Pagellus spp</i> )	
Redfish (-)	
Roach ( <i>Rutilus rutilus</i> )	

---

Rosefish / Norway Haddock ( <i>Sebastes marinus</i> )
Roughhead Grenadier ( <i>Coryphaenoides rupestris</i> )
Roundfish (-)
Roundnose Grenadier ( <i>Coryphaenoides rupestris</i> )
Saithe ( <i>Pollachius pollachius</i> )
Salmon ( <i>Salmo salar</i> )
Sand Steenbras ( <i>Lithognathus mormyrus</i> )
Sandeel ( <i>Ammodytes tobianus</i> )
Sardine / Pilchard ( <i>Sardina pilchardus</i> )
Sea Trout ( <i>Salmo trutta</i> )
Sea breams (-)
Seals (-)
Shortfin mako shark ( <i>Isurus oxyrinchus</i> )
Silver Scabbardfish ( <i>Lepidopus caudatus</i> )
Smelt ( <i>Osmerus eperlanus</i> )
Smooth Hound ( <i>Mustelus mustelus</i> )
Sole ( <i>Solea solea</i> )
Spanish Mackerel (-)
Sprat ( <i>Sprattus sprattus</i> )
Streaked Gurnard ( <i>Trigloporus lastoviza</i> )
Striped Red Mullet ( <i>Mullus barbatus</i> )
Swordfish ( <i>Xiphias gladius</i> )
Tub Gurnard ( <i>Chelidonichthys lucerna</i> )
Turbot ( <i>Scophthalmus maximus</i> )
Tusk ( <i>Brosme brosme</i> )
Vendace ( <i>Coregonus albula</i> )
Whitefish ( <i>Coregonus spp.</i> )
Whiting ( <i>Merlangius merlangus</i> )
Witch Flounder (Witch) ( <i>Glyptocephalus cynoglossus</i> )
Yellowtail flounder (-)

---

## **Annex 9 Minutes from web meeting with ICES re-calibration tool**

---

### **Skype meeting 12 October 2016 Monopoli, Italy**

Attending: Neil Holdsworth (ICES), Wim Allegaert (ILVO), Julie Davies (DTU-Aqua), Els Torreele (ILVO), Jane Aanestad Godiksen (IMR).

Subject: Consultation of WGBIOP with ICES about the status quo of WebGR and inventarisation of the possibility to start with an alternative tool i.e. SmartLab (ILVO, Belgium)

A full explanation of the Otolith Manager1.0 – Smartlab2.0 from ILVO was presented to ICES in terms of :

- the operating language (Microsoft SQL server database is used for coding and registration of data)
- the development platform – Microsoft .Net Framework and the application is in Windows WPF Client. WPF is advantageous as more possibilities to develop graphic tools.
- Demo of the tool for age reading, use of some features of the tool.

Otolith manager 1.0-SmartLab2.0, is developed as part of SmartFish, the Database platform within ILVO developed for the implementation and coordination of the Data Collection Framework.

The way how the tool is developed by ILVO, is an overall perfect match for ICES in terms of language and security: The tool is fully compatible with the ICES operating system and is very easy to adopt and adapt. ICES reluctance about taking over WebGR was the coding language and security issues which would be difficult to overcome. 'Smartfish' is compatible with ICES in regards to these 2 issues (as opposed to WebGR).

In terms of security the application is currently developed according ILVO institute requirements, and needs to be further developed for international use, however this is not a constraint for the future.

Smartfish and its tools were developed with the involvement of the age readers and their experience. .

The fact that Smartfish is Windows based could be an issue for Apple and Linux users but this can be circumvented by having a web browser. It can work off line using a FAT client and later synchronised with the database.

End of 2016, beginning of 2017 there will be a migration (at ILVO) from 2014SQL to 2016SQL. ICES are planning to do the same. An advantage of 2016SQL is the direct inclusion of reporting using R script. Smartfish V2 should be available in February 2017 and will coincide with this progression.

WGBIOP need to discuss how to be proceed in terms of:

- forming a consortium
- funding: this would probably be best from MS as opposed applying directly to the Commission
- how to continue working with WebGR now
- Can we rely on AZTI to host WebGR in the meantime

- look at schedule of upcoming WS and exchanges
- possibility of testing Smartfish at WKARSPRAT (to be decided)

The “Ownership” of Smartfish was discussed and agreed that recognition be given to ILVO with any publications.

Progression from version 2.0 towards version 3.0:

29<sup>th</sup> November there will be a meeting next to the SGRDB (Steering Group for the Regional Database) on how the development has been up to now and how to bring it forward to V3. The meeting will be attended by DTU-Aqua, ILVO and ICES Data Centre, with some ICES developers attending as well.. The new tool will need to be deployed as an independent application to make it more widely available. No migration of data will be done. One of the objectives of this meeting will be to discuss the time and resources needed for the development.

ILVO has SmartLab 2.0 installed Feb 1<sup>st</sup> 2017, followed by a WebEX with a Demo during the month February 2017 and followed by a discussion with ICES on how to proceed.

The version 3.0 can be based on the list of priority issues (including the use of Smartfish for maturity calibration etc. and how we develop a website).

Later synchronisation to the ICES server: according to ICES there are different options to do this, to be discussed later.

ICES mentioned that ILVO need to decide if there will be a full handover OR a copy.

## Annex 10 Full list of improvements for a calibration tool

ID	ISSUE	GROUP	DETAILED DESCRIPTION	TIME LINE	BUDGET (€)	PRIORITY	PROGRESS	PROGRESS DATE	SMARTFISH
1	Moving to ICES server					0			maybe
2	Offline access	Basic requirements	The possibility of annotating in WebGR without Internet access, with sub-sequent synchronization.			1			Yes
3	Option to have a blind exercise is	Basic requirements	Option to have a blind exercise is needed.			1			Yes
4	Prevent calibration exercise to	Basic requirements	Prevent calibration exercise to turn itself on during setup			1			Not relevant
5	Check for updated source codes	Security				1			Not relevant
6	Creating virtual machine	Security				1	?		Not relevant
7	Incorporate a functional back up	Security	Incorporate a functional back up system			1			Not relevant
8	sourceforge.com	Security				1	Done	nov.15	Not relevant
9	Update MySQL database	Security	The MySQL database server have to be updated to the latest version to make the application secure. For this reason the WebGR database, with all the data, need an update to be compatible with the new database server			1	?		Not relevant
10	Update PHPIDS	Security				1	Done	nov.15	Not relevant
11	Update ZendFramework 1.9 to	Security				1	Done	nov.15	Not relevant
12	Calibration exercise list needs to	Basic requirements	Calibration exercise list should be improved and sortable.			2			Possible
13	Improve search function to prevent timing out	Basic requirements	Improve search function for easier accessibility and making it more user friendly. At the moment it takes so long that the system times out during search.			2			Not relevant
14	Commucation of initiation of exercise	Database	When creating a workshop, an e-mail should be sent to the stock coordinators and readers of the species to inform of the action.			2			Possible
15	Deleting of images	Database	A workshop manager needs to be able to delete images from the database			2			Yes
16	Error messages needs description	Database	Error messages needs to come with a user friendly description of what to correct in order to proceed			2			Yes
17	Interface	Database	The interface needs to be more user-friendly. E.g. visibility of login frame			2			Not relevant

18	Visibility of results available to readers during exercise	Database	Only the workshop manager should have access to the statistical output during a calibration exercise. Right now, all readers can check other readers chosen ages and change their own ages according to that.			2			Possible
19	Work flow	Database	Need of sequential steps with a function preventing access to the next step if the previous step is not properly completed			2			Not relevant
20	.csv file template missing	Manual	Together with the template, it should be possible to download an example showing how to fill out a csv-file correctly			2			Not relevant
21	List of requirements needed	Manual	A list of requirements concerning e.g. image size and format is needed			2			Not relevant
22	The manual is not user friendly	Manual	Clear instructions needed on how to create a workshop is desirable.			2			Not relevant
23	Additional field for spawning check	Basic requirements	Inclusion of a field to note spawning checks in the otolith. Spawning checks are often used in assessment and it may be important to ensure the quality in these readings as well.			3			Possible
24	Calibration tool	Basic requirements	A tool for calibrating images directly in the programme if a known relationship between pixel ratio and actual measure was known, or the possibility to mark an actual value in mm or micrometres on the image. The programme will use that for calibrating distances. A tool for inserting a line through the otoliths (centre to edge) in order to show the readers which direction to annotate. That way all readers will have the annotations along the same axis.			3			Possible
25	Comment tool	Basic requirements	Comments to be included in the exported .csv-file and on the image			3			Possible
26	Comment tool	Basic requirements	The possibility to make a comment on a specific annotation and to have it appear on the image when in "Browse Annotation" mode			3			Possible
27	Double field aging for e.x. salmon	Basic requirements	Possibility of double field aging, which is necessary for some species like salmon to mark separately years spent at sea and in freshwater.			3			Possible

28	Image size	Basic requirements	Uploading of larger size/mosaic images, as those used e.g. for micro-increments count.			3			Yes
29	Interface not user friendly	Basic requirements	Some notification visible on the screen which clearly allows the readers to see if they are using "Annotation mode" or "Browse Annotation mode"			3			Not relevant
30	Readability field	Basic requirements	Inclusion of a field to note the readability (WKNARC 2011, 3 point scale) of the otolith.			3			Yes
31	Size and type of annotation symbol	Basic requirements	Availability and optional selection of different types and sizes of annotation symbols. E.g. micro-increments annotation (smaller symbol size) for species with very narrow zones.			3			Yes
32	Combining images	Database	The possibility of grouping of 2-3 images belonging to the same individual, as this is required for the examination of maturity stages. When annotating one image, all images of the same individual will automatically get the same result. This is also needed for micro-increments annotation in certain parts of otoliths, and it will be a huge advantage when dealing with species where both otolith and scale from the same fish is represented.			3			Yes
33	Workshop manager limitations	Database	The workshop manager should have permission to add new institute names and species to the attribute list, a right currently given only to WebGR administrator.			3			Possible
34	Image archive	Database	Image archive for tracabiliy and reconsulting when arranging new workshops			4			Yes
35	Multiple participants selection	Database	It would be advantageous to allow simultaneous addition of several participants to a workshop by clicking all names at once from the WebGR users list.			4			Possible
36	Multiple selection of images	Database	It should be possible to choose "all images" by one click when selecting images for a calibration exercise. At the moment, one has to click on every single image.			4			Yes



37	Annotation tool	Additional requirements	A tool that corrects for when the annotations are not in a straight line. This is particularly necessary for annotation of micro-increments in different sections of mosaic images where rings are more clearly visible (function available in TNPC).			5			No
38	Archiving of completed exercises	Database	An option to hide a calibration exercise once the exchange is finished, analysed and reported			5			Possible
39	Analysis of results to include Eltink output	Report	Statistical output combining current WebGR output and an Eltink spreadsheet improved format.			5			Possible
40	Analysis of results with improved statistics	Report	Adjustment of the statistics (and EltinkSpreadSheet) with sensitivity for short-lived and long-lived species ageing respectively.			5			Possible
41	Comparison of different images from the same fish	Report	Output allowing the comparison of age resulting from two or more structures of the same individual (e.g. otolith and scale).  A script has been developed which uses the "all distance" output from WebGR and examines differences in growth curves estimated by the different readers. This package can be developed to provide the statistical output required for exchanges. The extended statistical output will give a more complete and standardized evaluation of potential differences among readers/stagers.			5			Possible
42	Inadequate presence of statistical tools for quality assurance	Report				5			Possible
43	Standardized report	Report	It is envisioned that a standardized report can be compiled by WebGR which will provide both the results of the above-mentioned growth curve analysis and the supporting statistical output.			5			Possible

## **Annex 11 List of annually updated tables and documents**

---

- 1) Annex 11 List of annually updated tables and documents.  
WGBIOP update annually a number of files which are found on the Data Quality Assurance Repository:  
(<http://ices.dk/community/Pages/PGCCDBS-doc-repository.aspx>):
- 2) Guidelines:  
Guideline for Exchanges and Workshops on Age Reading.  
Guidelines for Workshops on Maturity Staging.
- 3) Tables:  
Material, techniques and preparation methods by species and areas for age estimation.  
Workshops, Exchanges and Study Groups Historical overview by species (Annex 7).  
Age Readers contact list.  
Maturity stagers contact list.

## Annex 12 Task sharing options

Country	Institute	Species	Area	Co-Ordinator	E-mail address	Reader	Structure	No. Collected each year	No. read each year	Method of otolith preparation	Birth Date	Interest in sending or receiving structures	Interest in sending or receiving readers	Year institute started sending stock	Year reader started sending stock	Ages used in assessment?	Training wanted from other institute?
EU Malta	DFA	Dolphinfish ( <i>Coryphaena hippurus</i> )	Med	Mark Gatt	<a href="mailto:mark.gatt@gov.mt">mark.gatt@gov.mt</a>	Frank Farrugia, Karl Cutajar	Otolith	300	250	Sectioned	Jan 1st	y	y	2010	2010	y	y
EU Malta	DFA	Swordfish ( <i>Xiphias gladius</i> )	Med	Mark Gatt	<a href="mailto:mark.gatt@gov.mt">mark.gatt@gov.mt</a>	Frank Farrugia, Karl Cutajar	Ray	40	40	Other	Jan 1st	y	y	2010	2010	y	y
Greece	HCMR-IMBRIW	Hake ( <i>Merluccius merluccius</i> )	20, 22, 23	Chryssi Mytilineou	<a href="mailto:chryssi@hcmr.gr">chryssi@hcmr.gr</a>	Evgenia Lefkaditou (main), Photiana Pattoura	Otolith	2000	1500	Whole	Jan 1st	y	y	1977	2005	y	n
Greece	ELGO-DEMETER	Hake ( <i>Merluccius merluccius</i> )	22	Angeliki Adamidou	<a href="mailto:adamidou@inale.gr">adamidou@inale.gr</a>	Angeliki Adamidou, Kostantinos G	Otolith	300	280	Whole	Jan 1st	y	y	1996	1988	-	n
Greece	HCMR-IMBRIW	Striped Red Mullet ( <i>Mullus barbatus</i> )	20, 22, 23	Chryssi Mytilineou	<a href="mailto:chryssi@hcmr.gr">chryssi@hcmr.gr</a>	Aikaterini Anastasopoulou (main), Arhontia Hatzispyrou, Vasiliki Kousteni	Otolith	1500	1200	Whole	June 1st	y	y	1977	2005	y	n
Greece	ELGO-DEMETER	Striped Red Mullet ( <i>Mullus barbatus</i> )	22	Angeliki Adamidou	<a href="mailto:adamidou@inale.gr">adamidou@inale.gr</a>	Vassiliki Papantoniou, Emilia Pana	Otolith	200	160	Whole	June 1st	y	y	1996	2013	-	n
Greece	HCMR-IMBRIW	Red Mullet ( <i>Mullus surmuletus</i> )	20, 22, 23	Chryssi Mytilineou	<a href="mailto:chryssi@hcmr.gr">chryssi@hcmr.gr</a>	Aikaterini Anastasopoulou (main), Vasiliki Kousteni	Otolith	800	800	Whole	June 1st	y	y	1977	2005	y	n
Greece	ELGO-DEMETER	Red Mullet ( <i>Mullus surmuletus</i> )	22	Angeliki Adamidou	<a href="mailto:adamidou@inale.gr">adamidou@inale.gr</a>	Vassiliki Papantoniou, Emilia Pana	Otolith	200	150	Whole	June 1st	y	y	1996	2013	-	n
Greece	HCMR-IMBRIW	Common Pandora ( <i>Pagellus erythrinus</i> )	22	Chryssi Mytilineou	<a href="mailto:chryssi@hcmr.gr">chryssi@hcmr.gr</a>	Paraskevi Niki Lampr	Otolith	500	500	Whole	June 1st	y	y	1988	2005	y	n
Greece	HCMR-IMBRIW	Picarel ( <i>Spicara smaris</i> )	22, 20, 23	Stelios Somarakis	<a href="mailto:somarak@hcmr.gr">somarak@hcmr.gr</a>	Stelios Somarakis (main), Petros Bekas	Otolith	1200	1200	Whole	April 1	y	n	1996	2014	y	n
Greece	HCMR-IMBRIW	Albacore ( <i>Thunnus alalunga</i> )	22, 20, 23	George Tserpes	<a href="mailto:gtserpes@hcmr.gr">gtserpes@hcmr.gr</a>	George Tserpes, Nota Periseraki, G	Ray	30	30	Sectioned	June 1st	n	y	1992	1992	y	n
Greece	HCMR-IMBRIW	Swordfish ( <i>Xiphias gladius</i> )	20, 22, 23	George Tserpes	<a href="mailto:gtserpes@hcmr.gr">gtserpes@hcmr.gr</a>	George Tserpes, Nota Periseraki, G	Ray	100	100	Sectioned	June 1st	n	y	1987	1987	y	n
Greece	ELGO-DEMETER	Sardine / Pilchard ( <i>Sardina pilchardus</i> )	22	Angeliki Adamidou	<a href="mailto:adamidou@inale.gr">adamidou@inale.gr</a>	Kostas Efthimiadis, Dimitra Panora	Otolith	1000	800	Whole	Jan 1st	y	y	1996	2003	y	n
Greece	HCMR-IMBRIW	Sardine / Pilchard ( <i>Sardina pilchardus</i> )	20, 22	Athanasios Machias	<a href="mailto:amachias@hcmr.gr">amachias@hcmr.gr</a>	John Fytalacos	Otolith	2000	2000	Whole	Jan 1st	y	y	1990	2013	y	n
Greece	ELGO-DEMETER	Anchovy ( <i>Engraulis encrasicolus</i> )	20, 22	Angeliki Adamidou	<a href="mailto:adamidou@inale.gr">adamidou@inale.gr</a>	Kostas Efthimiadis, Christina Milani	Otolith	1000	800	Whole	June 1st	y	y	1996	2003	y	n
Greece	HCMR-IMBRIW	Anchovy ( <i>Engraulis encrasicolus</i> )	20, 22	Athanasios Machias	<a href="mailto:amachias@hcmr.gr">amachias@hcmr.gr</a>	Athanasios Machias, John Fytalako	Otolith	2000	2000	Whole	June 1st	y	y	1990	2013	y	n
Greece	ELGO-DEMETER	Sole ( <i>Solea solea</i> )	22	Angeliki Adamidou	<a href="mailto:adamidou@inale.gr">adamidou@inale.gr</a>	Kostas Efthimiadis	Otolith	100	100	Whole	Jan 1st	y	y	1996	2003	y	y
Greece	ELGO-DEMETER	Horse Mackerel ( <i>Trachurus trachurus</i> )	20, 22	Angeliki Adamidou	<a href="mailto:adamidou@inale.gr">adamidou@inale.gr</a>	Thanasis Sioulas	Otolith	500	450	Whole	July 1st	y	y	1996	2013	y	n
Greece	ELGO-DEMETER	Mediterranean Horse Mackerel ( <i>Trachurus</i> )	20, 22	Angeliki Adamidou	<a href="mailto:adamidou@inale.gr">adamidou@inale.gr</a>	Thanasis Sioulas	Otolith	500	450	Whole	July 1st	y	y	1996	2013	y	n
Greece	ELGO-DEMETER	Mackerels ( <i>Scomber</i> spp)	20, 22	Angeliki Adamidou	<a href="mailto:adamidou@inale.gr">adamidou@inale.gr</a>	Anna Argyri, Athanasios Spetsiotis	Otolith	500	450	Whole	July 1st	y	y	1996	2013	y	n
Greece	ELGO-DEMETER	Atlantic Bonito ( <i>Sarda sarda</i> )	22	Angeliki Adamidou	<a href="mailto:adamidou@inale.gr">adamidou@inale.gr</a>	Kostas Efthimiadis	Otolith	100	70	Whole	June 1st	y	y	2013	2013	y	y
Greece	ELGO-DEMETER	Eel ( <i>Anguilla anguilla</i> )	22	Angeliki Adamidou	<a href="mailto:adamidou@inale.gr">adamidou@inale.gr</a>	Argiris Sapounidis	Otolith	200	200	Break & Burn		y	y	2012	2012	y	n
Greece	ELGO-DEMETER	Blackbelly anglerfish ( <i>Lophius budegassa</i> )	22	Angeliki Adamidou	<a href="mailto:adamidou@inale.gr">adamidou@inale.gr</a>	Angeliki Adamidou, Loukia Chatzia	Otolith	200	150	Whole	Jan 1st	y	y	2013	2013	y	y
Italy	ISMAR-CNR	Anchovy ( <i>Engraulis encrasicolus</i> )	37,2 (FAO)	Fortunata Donato	<a href="mailto:f.donato@ismar.cnr.it">f.donato@ismar.cnr.it</a>	Fortunata Donato	Otolith	1000	1000	Whole	June/July 1	n	y	1974	2003	y	y
Italy	ISMAR-CNR	Sardine / Pilchard ( <i>Sardina pilchardus</i> )	37,2 (FAO)	Fortunata Donato	<a href="mailto:f.donato@ismar.cnr.it">f.donato@ismar.cnr.it</a>	Fortunata Donato	Otolith	1000	1000	Whole	Jan 1st	n	y	1974	2003	y	y
Italy	ISMAR-CNR	Hake ( <i>Merluccius merluccius</i> )	37,2 (FAO)	Fortunata Donato	<a href="mailto:f.donato@ismar.cnr.it">f.donato@ismar.cnr.it</a>	Fortunata Donato	Otolith	500	500	Whole	Jan 1st	n	y	2006	2006	n	y
Italy	ISMAR-CNR	Monkfishes ( <i>Lophius</i> spp)	37,2 (FAO)	Fortunata Donato	<a href="mailto:f.donato@ismar.cnr.it">f.donato@ismar.cnr.it</a>	Fortunata Donato	Illicia	300	300	Sectioned	Jan 1st	n	y	2013	2013	n	y
Cyprus	DFMR	Bogue ( <i>Boops boops</i> )	GSA25	Charis Charilaou	<a href="mailto:ccharilaou@dfmr.moa.gov.cy">ccharilaou@dfmr.moa.gov.cy</a>	Ioannis Thasitis	Otolith	300	300	Whole	Jan 1st	y	y	2011	2014	y	y
Cyprus	DFMR	Common Pandora ( <i>Pagellus erythrinus</i> )	GSA25	Charis Charilaou	<a href="mailto:ccharilaou@dfmr.moa.gov.cy">ccharilaou@dfmr.moa.gov.cy</a>	Ioannis Thasitis	Otolith	300	300	Whole	Jul 1st	y	y	2011	2014	y	y
Cyprus	DFMR	Picarel ( <i>Spicara smaris</i> )	GSA25	Charis Charilaou	<a href="mailto:ccharilaou@dfmr.moa.gov.cy">ccharilaou@dfmr.moa.gov.cy</a>	Ioannis Thasitis	Otolith	300	300	Whole	Jan 1st	y	y	2011	2014	y	y
Cyprus	DFMR	Red Mullet ( <i>Mullus surmuletus</i> )	GSA25	Charis Charilaou	<a href="mailto:ccharilaou@dfmr.moa.gov.cy">ccharilaou@dfmr.moa.gov.cy</a>	Charis Charilaou	Otolith	400	400	Whole	Jul 1st	y	n	2011	2006	y	n
Cyprus	DFMR	Striped Red Mullet ( <i>Mullus barbatus</i> )	GSA25	Charis Charilaou	<a href="mailto:ccharilaou@dfmr.moa.gov.cy">ccharilaou@dfmr.moa.gov.cy</a>	Charis Charilaou	Otolith	500	500	Whole	Jul 1st	y	n	2011	2006	y	n
Italy	CNR-ISMAR	Flatfishes (-)	GFCM -GSA17	Sabrina Colella	<a href="mailto:s.colella@ismar.cnr.it">s.colella@ismar.cnr.it</a>	Sabrina Colella	Otolith	400	400	Whole	Jan 1st	y	y	1985	1995	n	n

Spain	IEO	Anchovy ( <i>Engraulis encrasicolus</i> )	GSA01	Alberto Garcia	<a href="mailto:agarcia@ma.ieo.es">agarcia@ma.ieo.es</a>	Pedro Torres	Otolith	600			1st	y	y	2003	2003	y	y
Spain	IEO	Anchovy ( <i>Engraulis encrasicolus</i> )	GSA01	Alberto Garcia	<a href="mailto:agarcia@ma.ieo.es">agarcia@ma.ieo.es</a>	Ana Ventero	Otolith	70	: MEDIAS		1st	y	y	2003	2012	y	y
Spain	IEO	Anchovy ( <i>Engraulis encrasicolus</i> )	GSA06	Alberto Garcia	<a href="mailto:agarcia@ma.ieo.es">agarcia@ma.ieo.es</a>	Ana Ventero	Otolith	800	: MEDIAS		1st	y	y	2003	2012	y	y
Spain	IEO	Anchovy ( <i>Engraulis encrasicolus</i> )	GSA06	Alberto Garcia	<a href="mailto:agarcia@ma.ieo.es">agarcia@ma.ieo.es</a>	Pedro Torres	Otolith	800			1st	y	y	2003	2003	y	y
Spain	IEO	Sardine / Pilchard ( <i>Sardina pilchardus</i> )	GSA01	Alberto Garcia	<a href="mailto:agarcia@ma.ieo.es">agarcia@ma.ieo.es</a>	Pedro Torres	Otolith	600	: MEDIAS		1st	y	y	2003	2012	y	y
Spain	IEO	Sardine / Pilchard ( <i>Sardina pilchardus</i> )	GSA01	Alberto Garcia	<a href="mailto:agarcia@ma.ieo.es">agarcia@ma.ieo.es</a>	Ana Ventero	Otolith	300			1st	y	y	2003	2012	y	y
Spain	IEO	Sardine / Pilchard ( <i>Sardina pilchardus</i> )	GSA06	Alberto Garcia	<a href="mailto:agarcia@ma.ieo.es">agarcia@ma.ieo.es</a>	Cristina Bultó	Otolith	1000	: MEDIAS		1st	y	y	2003	2012	y	y
Spain	IEO	Sardine / Pilchard ( <i>Sardina pilchardus</i> )	GSA06	Alberto Garcia	<a href="mailto:agarcia@ma.ieo.es">agarcia@ma.ieo.es</a>	Ana Ventero	Otolith	900			1st	y	y	2003	2012	y	y
Spain	IEO	Horse Mackerel ( <i>Trachurus trachurus</i> )	GSA01	Alberto Garcia	<a href="mailto:agarcia@ma.ieo.es">agarcia@ma.ieo.es</a>	Jesus Acosta	Otolith	400			1st	y	y	2003	2003	n	y
Spain	IEO	Horse Mackerel ( <i>Trachurus trachurus</i> )	GSA01	Alberto Garcia	<a href="mailto:agarcia@ma.ieo.es">agarcia@ma.ieo.es</a>	Pedro Torres	Otolith	400			1st	y	y	2003	2003	n	y
Spain	IEO	Mediterranean Horse Mackerel ( <i>Trachurus</i> )	GSA01	Alberto Garcia	<a href="mailto:agarcia@ma.ieo.es">agarcia@ma.ieo.es</a>	Jesus Acosta	Otolith	400			1st	y	y	2003	2003	n	y
Spain	IEO	Mediterranean Horse Mackerel ( <i>Trachurus</i> )	GSA01	Alberto Garcia	<a href="mailto:agarcia@ma.ieo.es">agarcia@ma.ieo.es</a>	Pedro Torres	Otolith	400		300 Whole	Jan 1st	y	y	2003	2003	n	y
Spain	IEO	Hake ( <i>Merluccius merluccius</i> )	GSA01	Alberto Garcia	<a href="mailto:agarcia@ma.ieo.es">agarcia@ma.ieo.es</a>	Jose L Perez Gil	Otolith	700	no internatio	Mounted in	Jan 1st	n	n	2003	2003	n	y
Spain	IEO	Hake ( <i>Merluccius merluccius</i> )	GSA06	Alberto Garcia	<a href="mailto:agarcia@ma.ieo.es">agarcia@ma.ieo.es</a>	Jose L Perez Gil	Otolith	419	no internatio	Mounted in	Jan 1st	n	n	2003	2003	n	y
Spain	IEO	Blue Whiting ( <i>Micromesistius poutassou</i> )	GSA06	Alberto Garcia	<a href="mailto:agarcia@ma.ieo.es">agarcia@ma.ieo.es</a>	Encarnacion Garcia	Otolith	1119	1119	Sectioned	Jan 1st	y	y	2010	2010	n	y
Spain	IEO	Chub Mackerel ( <i>Scomber japonicus</i> )	GSA06	Alberto Garcia	<a href="mailto:agarcia@ma.ieo.es">agarcia@ma.ieo.es</a>	Miguel Vivas	Otolith	382	382	Mounted in	Jan 1st	y	y	2011	2011	n	y
Spain	IEO	Monkfishes ( <i>Lophius spp</i> )	GSA06	Alberto Garcia	<a href="mailto:agarcia@ma.ieo.es">agarcia@ma.ieo.es</a>	Elena Barcala	Illicia	640	same otoliths 2 readers		1st	y	y	2003	2003	n	y
Spain	IEO	Red Mullet ( <i>Mullus surmuletus</i> )	GSA05	Alberto Garcia	<a href="mailto:agarcia@ma.ieo.es">agarcia@ma.ieo.es</a>	Natalia Gonzalez	Otolith	1000			1st	n	n	2003	2009	y	n
Spain	IEO	Red Mullet ( <i>Mullus surmuletus</i> )	GSA05	Alberto Garcia	<a href="mailto:agarcia@ma.ieo.es">agarcia@ma.ieo.es</a>	Xisco Ordinas	Otolith	1000			1st	n	n	2003	2009	y	n
Spain	IEO	Striped Red Mullet ( <i>Mullus barbatus</i> )	GSA06	Alberto Garcia	<a href="mailto:agarcia@ma.ieo.es">agarcia@ma.ieo.es</a>	Natalia Gonzalez	Otolith	800			1st	n	n	2003	2009	y	n
Spain	IEO	Striped Red Mullet ( <i>Mullus barbatus</i> )	GSA06	Alberto Garcia	<a href="mailto:agarcia@ma.ieo.es">agarcia@ma.ieo.es</a>	Xisco Ordinas	Otolith	800			1st	n	n	2003	2009	y	n
Italy	COISPA	Striped Red Mullet ( <i>Mullus barbatus</i> )	GSA10-18-19	Carbonara Pierluigi	<a href="mailto:carbonara@coispa.it">carbonara@coispa.it</a>	Carbonara, Casciaro	Otolith	3500			1st	y	n	1996	1996	y	n
Italy	COISPA	Bogue ( <i>Boops boops</i> )	GSA10-18-20	Carbonara Pierluigi	<a href="mailto:carbonara@coispa.it">carbonara@coispa.it</a>	Carbonara	Otolith	1000		1000 Whole	Jan 1st	y	n	1996	1996	n	n
Italy	COISPA	Hake ( <i>Merluccius merluccius</i> )	GSA10-18-21	Carbonara Pierluigi	<a href="mailto:carbonara@coispa.it">carbonara@coispa.it</a>	Carbonara	Otolith	5000		5000 Whole	Jan 1st	y	n	1996	1996	y	n
Italy	COISPA	Monkfishes ( <i>Lophius spp</i> )	GSA10-18-22	Carbonara Pierluigi	<a href="mailto:carbonara@coispa.it">carbonara@coispa.it</a>	Carbonara	Illicia	500		500 Whole	Jan 1st	y	n	1996	1996	n	n
Italy	COISPA	Horse Mackerel ( <i>Trachurus trachurus</i> )	GSA10-18-23	Carbonara Pierluigi	<a href="mailto:carbonara@coispa.it">carbonara@coispa.it</a>	Carbonara	Otolith	1500		1500 Whole	Jan 1st	y	n	1996	1996	n	n
Italy	COISPA	Mediterranean Horse Mackerel ( <i>Trachurus</i> )	GSA10-18-24	Carbonara Pierluigi	<a href="mailto:carbonara@coispa.it">carbonara@coispa.it</a>	Carbonara, Casciaro	Otolith	1200		1200 Whole	July 1st	y	n	1996	1996	n	n
Italy	COISPA	Picarel ( <i>Spicara smaris</i> )	GSA10-18-25	Carbonara Pierluigi	<a href="mailto:carbonara@coispa.it">carbonara@coispa.it</a>	Carbonara, Casciaro	Otolith	300		300 Whole	July 1st	y	n	1996	1996	n	n
Italy	COISPA	Sole ( <i>Solea solea</i> )	GSA10-18-26	Carbonara Pierluigi	<a href="mailto:carbonara@coispa.it">carbonara@coispa.it</a>	Carbonara, Casciaro	Otolith	50		50 Whole	Jan 1st	y	n	1996	1996	n	n
Italy	COISPA	Tub Gurnard ( <i>Chelidonichthys lucerna</i> )	GSA10-18-27	Carbonara Pierluigi	<a href="mailto:carbonara@coispa.it">carbonara@coispa.it</a>	Carbonara	Otolith	150		150 Whole	Jan 1st	y	n	1996	1996	n	n
Italy	COISPA	Grey Gurnard ( <i>Eutrigla gurnardus</i> )	GSA10-18-28	Carbonara Pierluigi	<a href="mailto:carbonara@coispa.it">carbonara@coispa.it</a>	Carbonara	Otolith	100		100 Whole	Jan 1st	y	n	1996	1996	n	n

## Annex 13 References

---

- FAO 2008. Models for an ecosystem approach to fisheries. *FAO Fisheries Technical Paper*. No. 477. Rome, FAO. 2007.108pp.
- ICES 2011. Report of the Workshop of National Age Readings Coordinators (WKNARC). ICES CM 2011/ACOM: 45.
- ICES 2012. Report of the Workshop for maturity staging chairs (WKMATCH). ICES CM 2012/ACOM: 58.
- ICES 2013. Report of the Second Workshop of National Age Reading Coordinators (WKNARC2). ICES CM 2013/ACOM: 52.
- ICES 2014a: Report of the Planning Group on Commercial Catches, Discards and Biological Sampling (PGCCDBS). ICES CM 2014/ACOM: 34.
- ICES 2014b: Report of the Workshop on Statistical Analysis of Biological Calibration Studies (WKSABCAL). ICES CM 2014/ACOM: 35.
- ICES 2015: Report of the Working Group on the Assessment of Demersal stocks in the North Sea and Skagerrak (WGNSSK). ICES CM 2015/ACOM: 13.
- Lehodey, P., Senina, I., & Murtugudde, R. (2008). A spatial ecosystem and populations dynamics model (SEAPODYM)–Modelling of tuna and tuna-like populations. *Progress in Oceanography*, 78(4): 304-318.
- Pauly, D., Christensen, V., & Walters, C. (2000). Ecospath, Ecosim, and Ecospace as tools for evaluating ecosystem impact of fisheries. *ICES Journal of Marine Science: Journal du Conseil*, 57(3): 697-706.
- Tjelmeland, S., & Lindstrøm, U. (2005). An ecosystem element added to the assessment of Norwegian spring-spawning herring: implementing predation by minke whales. *ICES Journal of Marine Science: Journal du Conseil*, 62(2): 285-29