

MD 13 2 / P.I.C.A.S.S.O. - IMAGES XI

(Paléoclimatologie Isotopes CAlypso pour les Séries Sédimentaires Océaniques)

à bord du Marion Dufresne



Fortaleza (Brésil), le 6 mai 2003

Brest, le 24 juin 2003

INSTITUT POLAIRE FRANÇAIS
Paul Emile Victor

Technopôle Brest-Iroise
BP 75 - 29280 Plouzané
FRANCE

Tél. 33 (0)2 98 05 65 00
Fax 33 (0)2 98 05 65 55
www.ifremer.fr/ifrtp/

Réf: OCE/2004/02

Dépôt légal : 2ème trimestre 2004

ISSN : 1246-7375

ISBN : 2-910180-33-6

MD132—P.I.C.A.S.S.O. IMAGES XI

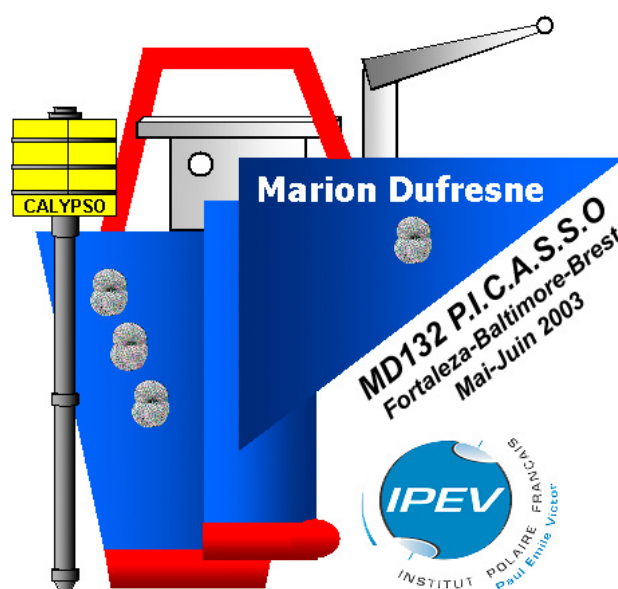

Chef de Mission
Carlo Laj

Chefs des Opérations
Yvon Balut
Xavier Morin

Cruise Report

06.05.2003—24.06.2003

Leg 1 : Fortaleza (Brasil)—Baltimore (USA)

Leg 2 : Baltimore (USA)—Brest (France)

Chief Scientist: CARLO LAJ ¹

Project Chiefs: LAURENT LABEYRIE ¹, CATHERINE KISSEL ¹

Chiefs of Operation: YVON BALUT ², XAVIER MORIN ²

Editor: STEFAN ROTHE ³

¹ LSCE, Unité Mixte CEA-CNRS, Avenue de la Terrasse, Bâtiment 12, 91 198 Gif sur Yvette, France

² Institut Polaire Français Paul-Emile Victor, Technopôle Brest-Iroise, B.P. 75, 29280 Plouzané, France

³ Universität Bremen, FB 5 Geowissenschaften, Klagenfurter Str. Geb. GEO, 28359 Bremen

Table of Contents

Acknowledgements

1. Introduction	5
1.1. Scientific Objectives of the P.I.C.A.S.S.O. Cruise	5
• Comparison between the Western Equatorial Atlantic and the Carribean Sea	6
• Comparative Evolution of Surface and Intermediate Waters in the Southern Carribean	7
• Cariaco Basin, Northern Venezuelan Margin	7
• Sea Level Changes and Paleoceanography from the Analysis of Sediments from the Pedro Bank, Walton Basin, Jamaica	11
• EXXON MOBIL Project in the Basin 4	12
• Blake Plateau and Cape Hatteras Coring	12
• The Chesapeake Bay Project	12
• Port Call at Baltimore	13
• The North Atlantic Transect: Eirik Drift, Gardar Drift, Feni Drift	14
1.2. Time Log of PICASSO Cruise	16
1.3. List of Cores	29
1.4. List of CTD Positions	30
1.5. List of Plankton Net Hauls	30
1.6. Lists of Participants	31
1.6.1. The Scientific Party	31
1.6.2. The Crew of R/V “Marion Dufresne”	32
1.6.3. The Malagasian Team of R/V “Marion Dufresne”	33
2. Coring and Sampling Methods, Core Handling	34
2.1. Coring	34
2.2. Core handling	35
2.2.1. Calypso and Gravity Cores	35
2.2.2. Calypso Square Cores (CASQ)	38
2.3. Plankton net hauls and seawater sampling	39
3. Shipboard Data Acquisition and Handling	39
3.1. Multibeam bathymetry and subbottom profiling	39
3.2. Station and area maps	42
3.3. MST	42
3.4. Physical Properties, Sampling	45
3.5. Colour reflectance using the Minolta 2002 spectrophotometer	45
3.6. Core photography	46
3.7. Sedimentology	46
Legend for sedimentological charts	47
3.7. Data management	48
4. Correlation of Calypso, Gravity and Square Cores from Site 58	49
5. Maps of Legs 1 and 2 of P.I.C.A.S.S.O. Cruise	51
6. Site Report and Core Documentation of Site 58 as Example	53
7. Visit of School Groups during Port Call in Baltimore	Back Cover

Acknowledgments

On behalf of the Scientific Party, it is my pleasure to thank all the persons who have contributed to the scientific achievements obtained during the 8 weeks of the P.I.C.A.S.S.O. cruise of the R/V Marion Dufresne, from Fortaleza (Brazil) to Brest (France).

Our thanks are first for the two Chief Operators, Yvon Balut and Xavier Morin, and the IPEV group composed of Valérie Hadoux, Alain Jaouen, Martin Mellet, Frédéric Rigault and Pierre Sangiardi, not forgetting the Malagasy team in charge of the coring operations.

The crew of the Marion Dufresne, under the commandment of Jean-Marc Léfèvre has also been one of the key factors for the scientific success of the P.I.C.A.S.S.O. cruise.

Carlo Laj

1. INTRODUCTION

The P.I.C.A.S.S.O. (Paleoclimatologie, Isotopes, Chimie, Atlantique, Séries Sédimentaires Océaniques) cruise on board the French research vessel «Marion Dufresne» took place in two legs. The first leg (May 5, June 5, 2003) was from Fortaleza (Brazil) to Baltimore (USA), the second (June 6-24, 2003) from Baltimore to Brest (France). Port calls were held at Port-of-Spain (Trinidad and Tobago), Kingston (Jamaica), Cozumel (Mexico) and Miami (USA). The scientific party partially changed at each port call. At Curaçao some members of the scientific party embarked and one disembarked by means of a launch.

The Chief Scientist was Carlo Laj, for the two legs. Project chiefs were Laurent Labeyrie and Carlo Laj for the first leg, Catherine Kissel and Carlo Laj for the second leg. The ship and the scientific technology for the cruise were provided by the Institut Polaire Paul-Emile Victor (IPEV) and the scientific program was strongly supported by a team from the IPEV under the direction of Yvon Balut (first leg) and Xavier Morin (second leg).

The P.I.C.A.S.S.O. cruise was organized within the framework of the international IMAGES program and was partly financed by complementary contribution from the European Community, Exxon-Mobil, the United States Naval Research Laboratory, and the United States Geological Survey. The scientific party was composed of research scientists and students from France, Belgium, Germany, Great Britain, Holland, Mexico, Norway, Spain, USA and Venezuela.

1.1 Scientific objectives of the P.I.C.A.S.S.O. cruise.

In a general way, the objective of the P.I.C.A.S.S.O. cruise was to recover very high accumulation rate sediments to decipher paleoclimatic and paleoceanographic changes on submillennial scales. Two periods of time were particularly investigated, the Holocene and, at a lower resolution, the last 2-3 climatic cycles, taking advantage of the different coring systems available on the Marion Dufresne.

The different sampling sites were in part chosen to fulfill the scientific program of previous cruises of the Marion Dufresne, when some sites had not been sampled because of lack of time. This is the case for the sites in the western Equatorial Atlantic and in the Caribbean Sea, and also for those of the Pedro bank in the Walton Basin, where all the sites had been scheduled during the 2002 PAGE cruise, but had not been sampled. In other cases, such as the North Atlantic Leg, part of the sites corresponds to previously sampled localities for which sediments were no longer available. On the basis of the results obtained from these previous sites, sampling was then extended in the different paleoceanographic zones, in order to fulfill the objectives of the European program PACLIVA. At each of the North Atlantic sites, coring was systematically conducted with two different sampling systems, the CALYPSO corer and either the giant square corer (called CASQ, or CALYPSO SQUARE) or a gravity corer. This strategy was also intended to circumvent the problems linked to possible stretching of the upper part of the long Calypso cores. New coring, notably in the Cariaco Basin, was supported by approved programs of the European Community and by grants from GFZ (Potsdam) and by NSF.

Finally, part of the coring done during the P.I.C.A.S.S.O. cruise corresponds to specific contracts signed by the IPEV (with Exxon Mobil and the USGS/NRL).

As part of the Educational Programs of the IPEV, and in collaboration with the American Geophysical Union, about 50 children from the 8th grade of the Key School of Annapolis visited the Marion Dufresne during the port call at Baltimore and had an overview of the different scientific programs pursued, particularly in the Chesapeake Bay.

The different scientific aspects of the P.I.C.A.S.S.O. cruise are briefly described below.

Comparison between the western Equatorial Atlantic and the Caribbean Sea

(PI: Joan Grimalt)

The marine regions around Central America are the areas of closer interaction between the northern and southern hydrographic cycles. Thus, the main passage for the transfer of warm surface water from the south into the north Atlantic is located in the western tropical Atlantic (Ruhlemann et al., 2001). The interactions between sea and atmosphere around Central America are also relevant for the potential east-west inter-basinal influence. The salinity differences between the Atlantic and the Pacific waters tend to favor the transport of humidity towards the former, whereas predominant trade winds promote transport in the opposite way. Accordingly, significant humidity changes have been recorded in Central America over the last 25 kyrs (Huang et al., 2001; Hodell et al., 1995; Curtis et al., 1996). The west to east humidity transfer may also be mediated by the South American riverine system, which discharges most of the water, collected over this continental area into the Atlantic Ocean. These marine-atmospheric interactions are also relevant for the changes in ITCZ positioning in both oceans along the glacial and interglacial periods.

Tropical areas have become a topic of priority research since the recent discovery of the good coupling between millennial scale climatic oscillations in high latitudes of the North Atlantic, e.g. the Dansgaard-Oeschger and Heinrich events (Bond et al., 1993; Grootes et al., 1993), and climatic changes in the tropics (Schulz et al., 2000; Peterson et al., 2000; Hüls and Zahn, 2000). These results are particularly relevant for the marine areas close to Central America. Precisely, these are some of the areas whose study has revealed these interlatitudinal parallelisms. In some cases the low latitude signal preceded the one at high latitude (Lea et al., 2000; Calvo et al., 2001) suggesting that small climate oscillations in the tropics could be at the origin of larger global climate changes such as those recorded in the North Atlantic and Greenland. In this respect, circulation changes north of South America (Ruhlemann et al., 2001) or through the Florida Straits (Lynch-Stieglitz et al., 1999) may have influenced the global thermohaline circulation system and northern high latitude climate.

The ocean regions nearby Central America are therefore located at the crossroads of the present climatic system that was established after the shoaling of the Central America seaway and the Panamanian isthmus formation (Mikolajewicz and Crowley, 1997; Haug et al., 2001). Surprisingly, the amount of paleoceanographic information available from these areas is rather limited. However, they offer a great potential for the elucidation of low latitude effects that may have triggered major climatic changes at high latitudes or at global scale.

Accordingly, two sites were chosen on the path of the Guiana and Caribbean Currents that carry warm South Atlantic surface water into the North Atlantic.

The specific objectives pursued concern the documentation of glacial/interglacial changes in the Caribbean Gulf Current flux at millennial and sub-millennial scale resolution and their relation to the Gulf stream current at higher latitudes, of glacial/interglacial changes of wind intensity over the western Atlantic and their impact on changes in moisture in Central America, of glacial/interglacial ITCZ latitudinal displacements in the western Atlantic, and finally on the relation of these ITCZ movements with changes in the Southern Oscillation

Studies will be conducted with a variety of geochemical tools, including measurement of the unsaturation index of the C₃₇ alkenones, of changes in the concentration of C₂₇-C₃₁ *n*-alkanes from higher plant origin, and determinations of $\delta^{18}\text{O}$ and $\delta^{13}\text{C}$ and AMS ¹⁴C measurements on monospecific foraminifera for the Holocene, last deglaciation and Stage 3 periods. Comparison of the downcore profiles of some of the above-mentioned proxies with the foraminiferal $\delta^{18}\text{O}$ records will allow elucidating leads and lags of climatic change in the tropics with respect to high latitudes.

Not only the two sampled sites do not overlap with previous high-resolution cores, but, in addition, in most of the previously studied sites, the geochemical proxies proposed in the present project were not

measured. Most of the information obtained will be new even from a methodological point of view. The sites proposed for study in the present project will also provide new information in relation to studies performed in lakes of the Yucatan Peninsula (20°38'N 87°37'W, Curtis et al., 1996, Hodell et al., 2001; 19°50'N 88°45'W, Hodell et al., 1995, 2001; 16°55'N 89°49'W, Huang et al., 2001). These lakes have allowed to illustrate changes in moisture over the Central American continent and the impact of these changes in the development and extinction of the Mayan civilization. The sites indicated in the present proposal will provide information to document whether these moisture changes were general phenomena over the whole region and whether they were essentially related to changes in the Pacific or the Atlantic areas.

Two cores were collected within the context of the P.I.C.A.S.S.O. Cruise for fulfillment of the above reported goals: MD03-2616 and MD03-2627.

Core MD03-2616 was recovered at 7° 48'N; 53° 2' W (1237 m water-depth) in the continental margin of the French Guyana within the Guyana current. A total of 39 m were retrieved consisting of olive green foraminiferal-coccolithophorid silt and clay. The entire core was rather homogeneous with slight bioturbation in some sections. Small dark spots indicate abundant organic matter remains. A preliminary biostratigraphic attempt using the abundances of *Globorotalia menardii* (biozones X, Y and Z) allow us to estimate an age of about 75 kyr for the top 7 meters and to infer ages older than 400 kyr for the whole recovered core.

Core MD03-2627 was recovered at 15° 42.44' N; 75° 02.19' W (3004 m water-depth). A total length of 39,02 m is mainly consisting of foraminiferal-coccolithophore silt. A preliminary biostratigraphic attempt places the base of this core at an age older than 1 Myr, close to isotope stage 35.

Comparative evolution of surface and intermediate waters in the Southern Caribbean

(PI. L. Labeyrie LSCE)

Site MD03-2618 (11°11'N, 59°14'W 1665m water depth) has been taken in the Pilar basin at the foot of Trinidad Island, in a site close to the well known site of core M35003-4 (12°09'N 61°24'W 1300m water depth) studied by Ruhlemann and others, to allow a comparison (and a possible generalization) of the results: core M35003 shows a very abrupt change in intermediate water characteristics at 1300 m depth during the early deglaciation, and warm events at each of the Northern cold events. These results are surprising, and important if confirmed. Core MD03-2618 will be studied in comparison with cores MD03-2616 and 2627, in association between the French and Spanish teams.

Near-by the site of MD03-2618, a core has been collected in the basin turbidite fan for sedimentological studies (PI T. Mulder and E. Gonthier, EPOC-Bordeaux)

Cariaco Basin, northern Venezuelan Margin

(PI's Gerald Haug, Larry Peterson, Juergen Thurow)

The Cariaco Basin is a relatively small, deep east-west trending depression on the northern continental shelf of Venezuela that is structurally similar to fault-bounded offshore basins along the California Borderland. What is called Cariaco Basin actually consists of two small sub-basins, each reaching depths of about 1400 m, and separated by a central saddle that shoals to about 900 m. Along its northern margin, the basin is bounded by a submarine ridge that extends from Isla Margarita west to Cabo Codera on the Venezuela mainland. The deepest connections through this ridge between Cariaco Basin and the open Caribbean are at depths close to 150 m near Farallon Centinela at the western end of the basin, and at about 120 m across the wider sill to the north between Isla Tortuga and Isla Margarita. These shallow sills severely restrict horizontal exchange with the open Caribbean, while vertical exchange is inhibited by the presence of a strong pycnocline below the mixed layer. Because of the limited deep-water renewal, dissolved oxygen in the Cariaco Basin below sill depth is not replenished rapidly enough to offset the demand created by high seasonal surface productivity. The result is total anoxia in the deep basin below a water depth of about 300 m, making Cariaco Basin the second largest body of anoxic water in the world today after the Black Sea and a natural modern analog for understanding the formation of hydrocarbon source rocks. High surface production and water column anoxia together lead to the presence of relatively high amounts of organic matter (3 to 6% organic carbon) in the sediments of this natural seafloor sediment trap.

Previous work in Cariaco Basin has demonstrated that sediments deposited here yield climate records that are nearly unparalleled in their detail and that serve as a rare tropical counterpart to high latitude ice cores for the study of abrupt climate change and the natural rhythm of climate in the recent geological past. The fidelity of the record is the result of high sediment accumulation rates (up to >100 cm/kyrs) and the almost complete lack of bioturbation imposed by the anoxic sea floor conditions. In addition, the finely laminated nature of much of the hemipelagic sequence provides an important means of constructing highly resolved age models since the paired sedimentary laminae, which appear as alternating light and dark layers, reflect the annual cycle of deposition and have been shown to be true varves. Strong seasonal signals in the surface waters overlying the basin are driven by changes in the strength and position of the Intertropical Convergence Zone (ITCZ). Between January and about April, when the ITCZ is south of the equator, strong trade winds in the tropical North Atlantic induce a slow Ekman drift to the west and northwest. This drift helps maintain the North Brazil and Guyana Current systems that direct surface flow northwestward towards the Caribbean as part of the surface limb of the Atlantic's thermohaline circulation cell. At the same time, the strong trade winds blowing along the northern Venezuelan coast result in intense upwelling of cool, nutrient waters which stimulate high levels of biologic surface production. Regionally, the upwelling season is the dry season because the ITCZ, along with its associated low pressure and convective rainfall, lies to the south. In contrast, beginning in June or July, the ITCZ moves north and takes up a position nearly overhead Cariaco Basin. As the trade winds diminish, the upwelling is weakened or largely shut off along the coast and the rainy season is triggered in northernmost South America. Increased rainfall in the region has a strong influence on sea surface salinity in the western tropical Atlantic and southern Caribbean through the discharge of the Amazon and Orinoco Rivers, as well as the smaller local rivers that drain directly into Cariaco Basin. Sediments of the Cariaco Basin accurately reflect the seasonal contrast in the input of biogenic and terrigenous materials, and hence offer opportunities to reconstruct variability in the circulation of the tropical atmosphere and ocean, and to investigate changes in the regional hydrologic balance over northern South America. As the oceanographic context is relatively well known, Cariaco Basin is also one of the best places in the modern ocean to study the early diagenetic processes that lead to the preservation of organic matter in marine sediments.

Seven stations were occupied in Cariaco Basin during the P.I.C.A.S.S.O. campaign, with recovery of a total of eight Calypso, gravity and Giant Square Corer (CASQ) cores. All coring, with the exception of the final gravity core MD032626, was focused on the top and upper flanks of the central saddle. Calypso cores MD032620 and MD032622 were recovered at the approximate location of Ocean Drilling Program Site 1002 on the western edge of the saddle. Calypso MD032621 targeted a region of higher known sedimentation rates on the eastern edge of the saddle, while Calypso cores MD032619 and MD032623 were collected on the upper part of the slope connecting the saddle to the deeper eastern sub-basin. Calypso MD032623 recovered the longest sediment sequence of 56.43 m while the other Calypso cores ranged in length between 43.04 m and 52.97 m. All of the Calypso coring locations on and around the central saddle was carefully targeted to avoid or minimize the potential for turbidites produced by seismic activity and/or climate forcing that are known to have affected the record at Site 1002. All coring sites are well within the present zone of anoxic bottom waters. Though gas expansion has affected at least some sections of all cores, there is no evidence for significant loss of sediment and the new Calypso cores can be easily correlated to each other and to high-latitude ice core records using reflectance data (Figure 1), as previously demonstrated for Site 1002.

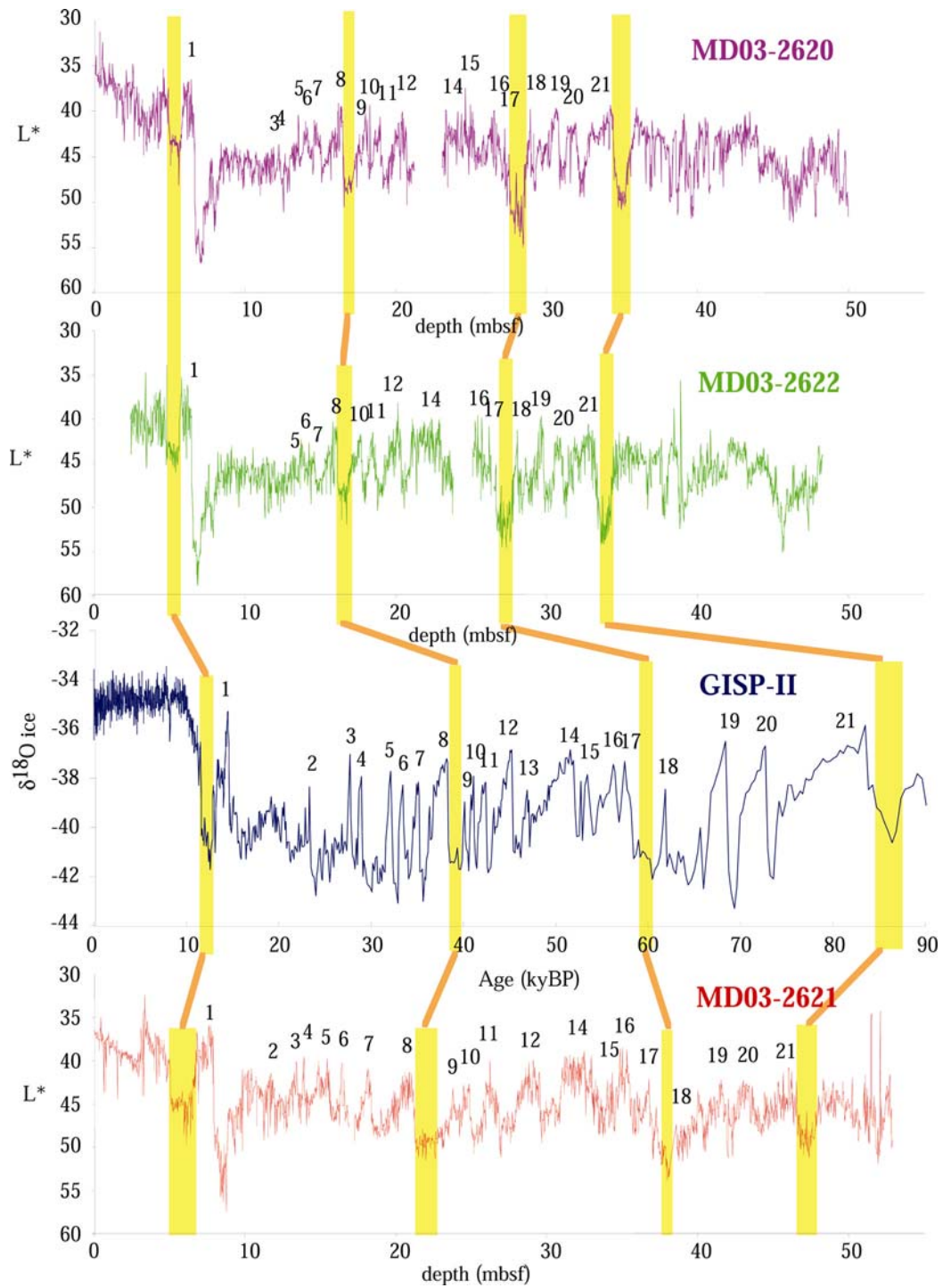

Fig. 1: Correlation of the sedimentary sequences from the Cariaco basin to the $\delta^{18}O$ record from GISP2 ice core. The parameter which is used for the correlation is the reflectance L^* measured on board as it clearly shows the rapid climatic variations during the last glacial period in the Cariaco Basin. The interstadials are numbered as in GISP2.

Long intervals of the cores are well laminated and the influence of turbidite sedimentation seems to be minimal to absent (Figure 2).

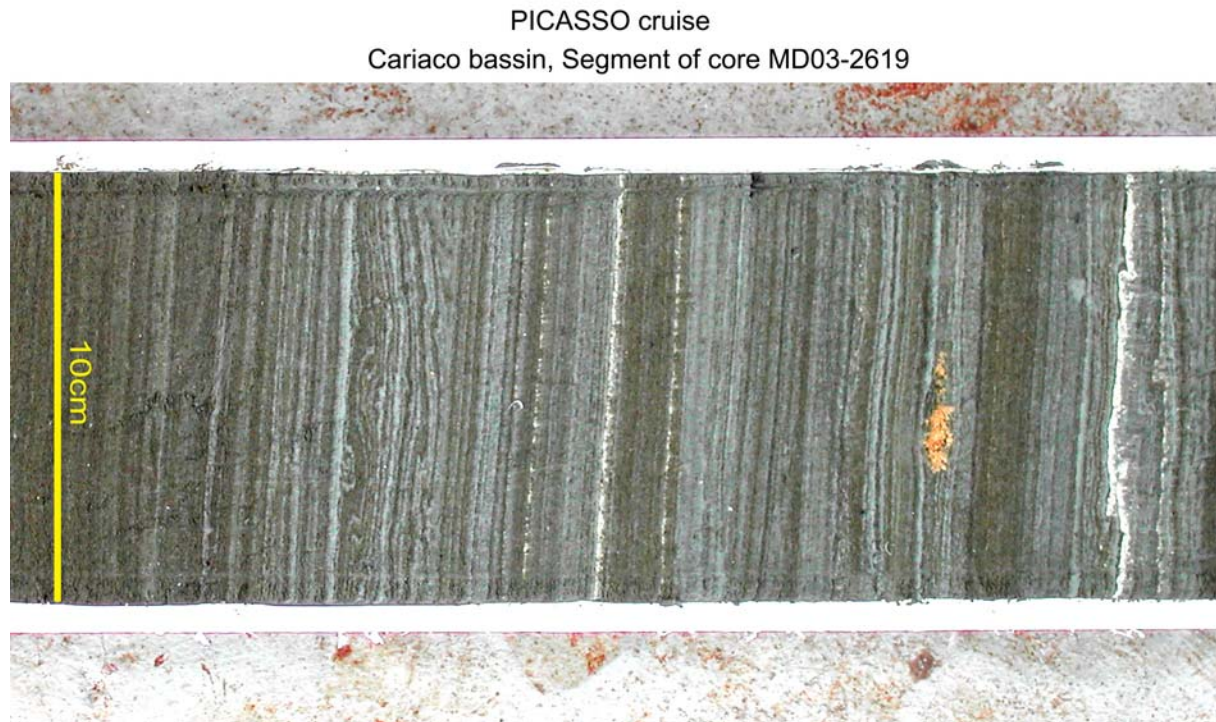

Fig. 2: varved sediment within Calypso Core MD03-2619, taken in the Cariaco Basin

Three prominent laminated intervals at the top of the sequence correspond to the Holocene, the Younger Dryas and the Bølling/Allerød. Below this there are annually laminated intervals, which, from ODP Site 1002, are known to correspond to Dansgaard/Oeschger cycles. Laminae studies from the new cores will provide an independent means to test the duration of the warm and cold episodes within these cycles. At this point we expect that the clearly laminated interval towards the bottom of the recovered sequences in several Calypso cores corresponds to Marine Isotope Stage (MIS) 5.

In addition to the Calypso cores, two CASQ cores (MD032624 and MD032625) were attempted close to the location of MD032621 but recovery was hampered (8.08 m and 5.28 m, respectively) by the cohesive late glacial clays that prevented the core catcher from fully closing. Gravity core MD032626 was taken on the deep floor of the western sub-basin (water depth of 1332 m) as the *Marion Dufresne* exited Cariaco Basin while underway to Curacao. The resulting 9.13 m gravity core penetrated a sequence permeated with turbidites that will be used to examine downslope sediment transport and the role of local earthquakes and sea level in turbidite generation.

Results obtained from the new sediment sequences will greatly add to our understanding of tropical climate history and will help evaluate recent hypotheses suggesting that the tropics may be an important source of climate variability. A wide variety of coordinated analyses are planned that build upon early results obtained from ODP Site 1002. The new cores recovered during the PICASSO cruise provide a large volume of fresh sediments that will allow for a combination of careful laminae-based studies, non-destructive bulk sediment measurements (e.g., scanning X-Ray Fluorescence, environmental magnetic properties), and sample intensive proxy studies at sampling resolutions not possible with the one existing ODP site. Using a combination of digital sediment color analysis, X-ray and backscatter electron imagery, we will study these records with annual or near-annual resolution from the base of MIS 5 to understand a) the history of mean-state, frequency, and amplitude of El Niño Southern Oscillation-cycles, b) the history of decadal/multi-decadal climate cycles, and c) to see if high resolution climate signals can be correlated with similar records in the East Pacific and Gulf of California. These records will be supplemented by a wide suite of geochemical, micropaleontological and sediment physical proxy measurements at varying resolutions, including foraminiferal $\delta^{18}\text{O}$ and

$\delta^{13}\text{C}$, Mg/Ca for sea surface temperatures, sediment $\delta^{15}\text{N}$, foraminiferal assemblages, biogenic sediment composition (carbonate, opal, organic carbon), and terrigenous measures such as XRF-based Ti and Fe, clay mineralogy and grain size. In addition, a subsection of CASQ core MD032625 will be studied at Lille University (UMR 8110 and FR 1818) in order to determine the preservation processes responsible for the high organic content of the sediments. Comparison of these data with data from the extensively studied ODP Site 1002, where sedimentation rates are slightly lower, will contribute to a better understanding of the role of sedimentation rates in the preservation of organic matter.

Postcruise studies of the new PICASSO cores from Cariaco Basin will help document climate signals preserved in this extraordinary sediment sequence at various times in the Holocene/Late Glacial and during MIS 5. They will provide information on the strength of these signals and allow a determination of how changes in the am

The amplitude/frequency of one cycle may have influenced others. As such, the results will contribute important information relevant to the understanding of high frequency climate variability in the context of regional to global climate change.

Sea Level Changes and Paleoceanography from the Analysis of Sediments from the Pedro Bank, Walton Basin, Jamaica

(PIs: E. Bard, K. Tachikawa, L. Vidal, L. Labeyrie, E; Cortijo, André Droxler)

Mass spectrometric U/Th dating has allowed to evaluate the consistency between the chronology of Pleistocene high marine levels with the predictions of the astronomical theory of climate change. Precise comparisons have been obtained in particular from corals (e.g. Edwards al. 1987 *Science* 236, 547, Bard et al. 1990 *Nature* 346, 456) and speleothems sampled in submerged caves (e.g. Li et al. 1989, *Nature* 339, 534, Bard et al. 2002, *EPSL* 196, 135). A third approach is based on the dating of peculiar oceanic sediments rich in aragonite (and therefore in U) and containing foraminifera for 18O/16O measurements. (e.g. Slowey et al. 1996, *Nature* 383, 242) The results focused on Termination II (Henderson & Slowey 2000, *Nature* 404, 6) suggest that the penultimate deglaciation was centered around 135 kyr BP, i.e. 10 kyr earlier than estimated through the "classical" astronomical theory (Imbrie et al. 1984, NATO pub, 269).

We aim at refining the results obtained by Henderson and Slowey using the Pedro Bank samples. The study by these authors was based on U/Th dating influenced by alpha-recoil and inherited Th. In addition, U/Th measurements are measured on fine-grained aragonite, while foraminifera belong to the coarse-grained fraction. Artifacts arising from physical re-suspensions and/or bioturbation of sediments could thus modify the chronological relationship between the different size fractions (e.g. Bard 2001, *Paleoceanography* 16, 235). Furthermore, the assumed relationship between foraminiferal 18O/16O and the sea level needs further evaluation. Indeed, the global sea level change related to ice volume accounts for only half of the observed foraminiferal 18O/16O variations, which implies that local temperature and salinity changes are not negligible.

The sediments from the Pedro Bank offer an excellent opportunity to perform a study similar to that from the Bahamas and to test the different hypotheses related to this approach. In the Pedro Bank sediments, fine-grained aragonite is well preserved at shallow depth (Haddad and Droxler 1996, *Paleoceanography* 11, 701), which allows us to apply both U/Th and 14C dating for the last Termination. To establish a precise chronology of the different size fractions, it will be interesting to measure the 18O/16O ratio of the foraminifera and of fine-grained aragonite, as well as the paleotemperature proxies UK'37 and foraminiferal Mg/Ca ratios.

The two Calypso cores (MD03-2628 (17°21.26N, 77°42.45W, water depth 846 m, length 26.57 m) and MD03-2629 (17°46.99N, 77°53.18W, water depth 513 m, length 13,45 m) as well as a giant square core MD03-2331 (17°59.42N, 77°59.42, water depth 291 m, length 6.9 m) have been collected specifically with this goal. As a first step, it will be crucial to quantify the abundance of fine-grained aragonite in the sediments to choose the most suitable core(s) for this study.

In complement to the study of the deep intermediate waters conducted in the Southern Caribbean Sea, the 4 cores from Walton Basin (MD03-2628 to 2632) will offer a unique opportunity to study the variability of the shallow intermediate waters (between 300 and 1300 m water depth) across rapid climatic changes, in relations to surface water hydrology and global climate.

Dating of the Aragonite by U/Th and Aragonite+foraminifera by ^{14}C will be done under the responsibility of the CEREGE team, as well as UK'37 and planktic foraminiferal $^{18}\text{O}/^{16}\text{O}$ and Mg/Ca ratios (E. Bard, K. Tachikawa, L. Vidal). The LSCE-Gif team (L. Labeyrie and E. Cortijo) will be in charge of the benthic foraminifera $^{8}\text{O}/^{16}\text{O}$ and Mg/Ca ratios. A. Droxler (Rice University) is in charge of the sedimentology study, in particular the inter-relationships between sea level and carbonate platform sedimentation around MIS 11.

Exxon Project in the Basin 4

(PI's Vitor Abreu, André Droxler, Laurent Labeyrie)

The goal of the study was to collect piston cores in the Basin 4 of the East Breaks mini-basins in the Gulf of Mexico. The East Breaks mini-basins are located in the middle Texas continental slope between $94^{\circ} 16'$ and $94^{\circ} 30'$ longitude and $27^{\circ} 14'$ and $27^{\circ} 26'$ latitude at approximately 1500-m water depth. The Basin 4 of East Breaks represents the terminal portion of a chain of four Pleistocene intra-slope basins often referred to as the Brazos-Trinity Intra-Slope System. The 2003 East Breaks Coring Program collected sediment samples through piston coring of the upper deep-water sandy system (hereinafter called Upper Fan) present at the upper portion of the sedimentary fill of the Basin 4. The Upper Fan is a large submarine fan (8 kilometers wide and 16 kilometers long) with a maximum thickness of 100 meters. The 2003 East Breaks Coring Program recovered 322 meters of cores in 15 locations (MD03-2633 to MD03-2647), and the results of the sedimentological and paleontological studies will provide information on the sedimentary processes and timing of the infilling of the Basin 4. The paleoclimatic study of cores MD03-2641 and MD03-2643, which sampled the mostly hemi-pelagic sedimentation at the Southeast of the basin are open for paleoclimatic studies under the responsibility of L. Labeyrie (PI).

Blake Plateau and Cape Hatteras coring

(PI: Laurent Labeyrie)

The cores on Blake plateau (MD03-2648 to 2652) have been recovered along a depth gradient (400 to 960 m water depth) to test the possibility to follow the thermocline variations during the last thousand years. On these cores, the vertical distribution of temperature and salinity will be reconstructed using the oxygen isotopic ratio and trace element content (Mg/Ca) in several species of foraminifera accumulated in the sediment. The observed variability will be compared with continental records of past climate changes, and potential links and teleconnections will be tested with General Circulation models. These results will be compared with the reconstructed hydrological variability during an older period with known high amplitude climatic changes: the drastic cooling at 12 ka BP. To reach these objectives, the coring technique was fundamental, in order to preserve as well as possible the sediment surface and the last hundred years, normally destroyed by traditional coring techniques. Five cores have been collected on Blake Plateau, 2 Calypso and 3 gravity cores. One core was collected on Cape Hatteras (MD03-2653, 1 CASQ) at the same site of core MD99-2203 in order to study the last interval of 2000-0 kyr. The studies conducted on core MD99-2203 show an excellent area to study in great details the Holocene section, but the Calypso coring did not allow the recovery of the last millennia. The CASQ cores will allow a good study of this time interval, in the context of the PACLIVA European project (coordinator: E. Jansen from BCCR, Bergen). As a first objective, an oxygen isotope record will be produced to determine the stratigraphy of the cores.

The Chesapeake Bay project

(PI's: Debra Willard, Peter Vogt, Thomas Cronin)

Chesapeake Bay is the largest estuary in the United States, with a length of approximately 320 km, covering an area of $6,500 \text{ km}^2$, and draining a watershed of $166,000 \text{ km}^2$. The modern bay formed when post-glacial sea-level rise flooded the dendritic river system of the paleo-Susquehanna River approximately 7,500 years ago. Previous research in Chesapeake Bay has documented sites of rapid Holocene sedimentation, yielding high-resolution records of Holocene paleoclimate, sea-level rise, and the response of the estuarine ecosystem to natural and anthropogenic changes. Most previous research has been limited by coring methods, which typically capture only the upper 4-5 meters of sediment, corresponding to the latest Holocene in many sites. A previous cruise of the *Marion Dufresne* to Chesapeake Bay in 1999 obtained one long (20.5 m) sediment core extending back ~10,000 years and others as old as 7,500 yr BP. Among the goals of sediment coring on the

PICASSO cruise are collection of records including fluvial sediments predating the early Holocene sea-level rise that flooded the bay and collection of more complete, well-resolved Holocene sequences to study climatic, geologic, oceanographic, chemical, and land-use impacts on Chesapeake Bay. Such records will be used to address issues related to dissolved oxygen, sedimentation, water chemistry, benthic organisms, and phytoplankton assemblages. Another goal is to collect a transect of cores from southern to northern reaches of the bay with sufficient temporal resolution to study past climatic patterns with decadal resolution.

Coring with the *Marion Dufresne* during the PICASSO cruise resulted in collection of four giant Calypso cores ranging from 17 to 25 meters long and several shorter gravity cores. Seven stations were occupied, from the southernmost bay (MD03-2654) to the northern mid-bay (MD03-2661). Six sites (MD03-2654 to MD03-2656, and MD03-2659 to MD03-2663) were positioned in the bay channel where Holocene sedimentation rates were known to be rapid. At two of those sites (MD03-2655 and -2656 and MD03-2659 and -2660), paired Calypso cores were collected: one exclusively for pore water analyses and another for all remaining analyses. At one of the sites (MD03-2662), a gravity core was collected because methane gas made the sediments acoustically non-transparent. Its use was justified when hard sediments were encountered at a shallow depth, resulting in a 0.89 m core. Similarly, gravity cores were collected at the two last interglacial sites (MD03-2657 and -2658), where sands were encountered at relatively shallow depths.

The long Calypso cores are anticipated to have obtained: the first recovery of the entire Holocene from the northern part of the mid-bay; the first cores from the deepest basins in the mid-bay to recover Pleistocene sediments; the first Chesapeake Bay core recovery of last interglacial channel fill from 125,000 years ago; the first cores collected for study of pore water methane geochemistry in southern bay sediments; and first sampling of post-colonial sediments for organic biomarkers. Post cruise studies of these records will expand our knowledge of the influence of currents, geology, bathymetry, climate, and land use on sedimentation and turbidity. In addition, they will provide data on the impact of climate variability such as El Niño and the North Atlantic Oscillation on the Chesapeake Bay ecosystem and help evaluate hypotheses on the relative impacts of human activities vs. climatic events on the system. New insights also will be gained into the rates, impacts, and causes of sea-level rise in Chesapeake Bay and the possible role of Antarctic ice sheet melting in the sea-level rise that formed the bay around 8,000 yr BP. Core evidence (lithology, sediment logging) will be used to groundtruth geophysical surveys, and porewater geochemistry will be used to study the age, distribution, origin, and fate of methane in bay sediments.

**Port Call at Baltimore (5-6 June, 2003):
a visit of the Marion Dufresne by 50 8th graders of the Key School at Annapolis.**

As part of the Educational Programs of the IPEV, and in collaboration with the American Geophysical Union, about 50 children from the 8th grade of the Key School of Annapolis visited the Marion Dufresne in the morning of June 6, during the port call at Baltimore.

Yvon Balut and Carlo Laj greeted the children. After the traditional group photograph at the bow of the ship, the children visited the deck and got acquainted with the main controls of the boat. Then they moved to the scientific "headquarters" where they were briefed about the scientific aspects of the cruise. First, Yvon Balut described the main scientific equipments of the boat, including the different coring systems and they way coring is controlled. Carlo Laj gave a short account about the main objectives of the Picasso Cruise and described the part of the cruise that had already taken place before the Baltimore port call. USGS scientists Debra Willard and Tom Cronin then described the specific objectives of the cruise in the Chesapeake Bay, and how these scientific studies lead to a deeper understanding of the environmental evolution of the Bay. Visual inspection of some of the cores taken from the Bay led to live discussion among the children and questions to the scientists.

Thanks to the "Chef" of the Marion Dufresne, the children had an opportunity to sample "French Patisserie", before departing from the boat after a two-hours visit.

Some aspects of the visit are pictured in the photographs (shown on the back cover of this report).

The North Atlantic Transect: Eirik Drift, Gardar Drift, Feni Drift)

(PIs: Catherine Kissel, Carlo Laj)

Multiple scientific objectives were pursued during the North Atlantic transect with coring taking place in the Eirik, Gardar and Feni drifts: characterization of surface hydrology, climate changes, changes in the strength of the North Atlantic Deep Water (NADW), finally geomagnetic goals. All these objectives will be pursued using a variety of laboratory approaches and methods, such as isotopic measurements, sortable silt studies, mineral magnetic and X-Ray fluorescence analysis. The high accumulation rate sediments from these drifts that include fairly extended Holocene sections, will allow to study the two main time slices targeted for PACLIVA (0-2000 and 6000-8000 years) with the required time resolution.

A common characteristic of the three investigated area and of the investigated depths (1650 – 3400 m) is to be on the way of the deep water mass injected at present from the Nordic seas into North Atlantic. The production and dynamics of this dense and cold water mass (North Atlantic Deep Water (NADW)) which is one of the most important elements of the thermohaline circulation have obviously changed in the past. It has been shown that it underwent very rapid changes (millennial-scale) during the last glacial period. At present, the different branches of the NADW correspond to different overflows from Nordic seas: through the Faeroe-Shetland channel, the Denmark Strait and a minor one east of Iceland. From northeast to southwest, overflowing into the North Atlantic, the deep water mass follows the bottom topography first along the Feni drift, around the Rockall plateau, along the Gardar Drift, northward again along the western side of the Reykjanes ridge and re-enforced by the water passing through the Denmark strait, along the Irminger basin and the Eirik Drift. During the last glacial maximum, the convection was stopped in the Nordic seas and the deep water was replaced by intermediate water in the North Atlantic. Every intermediate pattern between these two extremes existed in the past as it has been shown for the Heinrich and Dansgaard-Oeschger cycles.

The distribution of the cores will allow to monitor past changes in the deep circulation, related to changes in surface hydrology and temperature. In particular, they will give us an opportunity to determine the role played by the Faeroe-Shetland channel and the Denmark Strait in the dynamics of the deep water and the associated sediment supply and how the relative contribution of these overflows has changed in the past.

The Eirik Drift sites provide a unique insight into the surface hydrological variability related to the Labrador current and the input of surface water from the Irminger Basin. In addition, sediments from this drift allow to retrace the fluctuations of deep water masses: the upper layer of the NADW, the deep Labrador current and the deep overflow from the Irminger Basin through the Denmark Strait. The exceptionally good weather conditions allowed to sample at four sites (two of which are close to sites previously envisaged for the GINNA 1999 cruise of the Marion Dufresne, but which had not been sampled because of lack of time). Weather conditions also allowed to systematically use two types of corers at each site. The Calypso corer was always used and either (and mostly) the giant square corer (CASQ) or the gravity corer. The rationale for this double coring is that, despite considerable progress, the Calypso corer is known to sometimes slightly stretch the upper 5-10 meters of sediments. On the other hand, no stretching occurs when the CASQ is used, so that undisturbed sedimentary sequences can be obtained by using the upper records from the CASQ spliced with the lower part of the Calypso cores. Correlation between the two corers can usually be unambiguously done using the shipboard records of the reflectance.

4 sites were cored in the Eirik Drift, and a total of 8 cores were obtained (4 Calypso, 2 CASQ and 2 gravity cores). The Calypso cores average about 40 meters in length and the 2 CASQ about 11 meters (for a maximum of 12 m). Cores MD03-2664 and MD03-2665 were sampled for physical properties studies directly on board to avoid desiccation.

The 6 stations occupied in the Gardar Drift are ideally placed to study past changes in the NADW. This area is the place where the deep water is propagating southward from the Norwegian Sea during the present time and where the intermediate waters were generated during the glacial period. The Holocene sequences that were recovered at these sites using the CASQ (which was used preferentially to the gravity corer) will allow to meet the goals of the PACLIVA program. 6 sites as a total were cored, along a North-South transect (from 61° N to 56° N), yielding 6 Calypso, 5 CASQ and 2 gravity cores. The last of the Gardar Drift sites was triple cored with the 3 corers. Correlation of the reflectance records measured on board allows to illustrate the effects of the Calypso corer (stretching) with that of the gravity corer (compaction) and the CASQ (probably no effect) as shown in **Chapter 4**.

Finally, only one site could be sampled in the Feni Drift, because of lack of time. One Calypso core and one CASQ core were obtained from this site which is located along the way of the warm surface waters of the north Atlantic current and along the initial branch of the NADW flowing out of the Norwegian sea.

1.2 Time Log of PICASSO cruise

Date [UTC]	Station	Time [UTC]	Latitude N	Longitude W	Water depth[m]	Operations
06.05.2003		14:30				Departure from Fortaleza
08.05.2003	1	13:10				Arrival on Station 1
		13:45	07°48.75	053°00.80	1233	Coring Calypso core MD03-2616
		15:00				Core on deck, length 39,33 m , corer bent
		16:00				Departure from Station 1
09.05.2003	2	13:05	10°23.10	058°50.66	1842	Arrival on Station 2
		14:34				Coring Calypso Core MD03-2617
		15:24				Trigger
						Core on deck, length 33,38 m, corer slightly bent
09.05.2003	3	20:05	11°08.30	059°15.36		Begin survey for coring in the "Pilar Area"
		02:55	11°11.13	059°13.83	1641	Station 3, begin coring operations
		04:55				Trigger
		05:51				Core on deck, corer empty, no name for this coring
10.05.2003	3bis	08:15	11°11.33	059°13.76	1665	Begin coring operations, core MD03-2618
		10:05				Core on deck, length 36,48 m
		10:19				Departure from station 3bis
						Route to Port of Spain
10.05.2003						Port of Spain
11.05.2003						Port of Spain
CARIACO BASIN						
12.05.2003		14:20				Begin Survey in the Cariaco Basin
12.05.2003	4	19:45	10°39.05	064°54.80	949	Arrival on Station 4
	4	19:47				Begin coring operations core MD03-2619
						Calypso corer, tube length 43,90 m
		21:44				Core on deck, length 43.04m
						Departure to Station 5
13.05.2003	5	00:59	10°42.37	065°10.17	876	Arrival on Station 5 (ODP Site 1002)
		01:00				Begin coring operations for core MD03-2620
						Calypso corer, tube length 59,35 m
		02:45				Core on deck, length 49,93 upper part of corer slightly bent
						Departure to Station 6

Date [UTC]	Station	Time [UTC]	Latitude N	Longitude W	Water depth[m]	Operations
13.05.2003	6	11:00	10°40.69	064°58.29	847	Arrival on Station 6
		11:15				Begin coring operations for Core MD03-2621
		11:43				Calypso corer, tube length 59,05
		13:00				Trigger
		13:15				Core on deck, length 52,97 m Departure to Station 7
13.05.2003	7	18:50	10°42.37	065°10.15	877	Arrival at Station 7 (ODP Site 1002)
		18:55				Begin coring operations for core MD03-2622
		19:37				Calypso corer, tube length 54,70 m
		21:45				Trigger Core on deck, length 48,30 m Departure to Station 8
14.05.2003	8	04:37	10°39.06	064°54.75	949	Arrival at Station 8
		04:53				Begin coring operations for core MD03-2623 (high sed rate core)
		05:19				Calypso corer, tube length 60,85 m
		06:30				Trigger Core on deck, length 56,43 m Departure from Station 8
14.05.2003	9	10:08	10°40.65	064°58.24	850	Arrival at Station 9
		10:21				Giant Square Corer Begin operation for coring core MD03-2624
		10:46				Touchdown
		11:37				Core on deck, length 8,08 m Decision to sample rapidly and core again
14.05.2003	10	14:46	10°40.65	064°58.24		Ready for second operation: core MD03-2625
		15:37				Giant Square Corer
		16:30				Touchdown Core on deck, length 5,08 m Sediment too dry to allow closing of the shutters
		16:45				Departure to Station 11
14.05.2003	11	18:41	10°49.39	065°21.31		Arrival on Station 11
		18:42				Begin operations for coring core MD03-2626
		19:40				Gravity core, tube length 18,00 m located in the deep basin, possibly for paleo-seismic activity studies
		19:58				Core on deck, length 9,13 m Departure for Curaçao

END OF CARIACO BASIN

Date [UTC]	Station	Time [UTC]	Latitude N	Longitude W	Water depth[m]	Operations
15.05.2003		13:00				Arrival at Curaçao (Pilot boat)
		14:00				Departure from Curaçao
16.05.2003	12	18:00				Begin survey for Station 12 (Colombian Sea)
		20:25	15°43.30	075°01.93	2984	
		20:30				Begin operations for coring core MD03-2627
						Calypso Corer, tube length 45,28 m
		21:35				Trigger
		23:00				Core on deck, length 39,57 m
		23:05			Departure to Kingston (Jamaica)	
KINGSTON HARBOUR						
17.05.2003		11:00				Approach to Kingston Harbour
		11:50				At Pier in Kingston Harbour
		16:00				Departure from Kingston Harbour Route to Station 13
WALTON BASIN						
17.05.2003		22:30				Survey around Station 13 Walton Basin
18.05.2003		00:48	17°21.62	077°42.45	846	On station
		01:00				Begin operations for coring core MD03-2628
		01:27				Calypso corer, tube length 45,28 m Trigger Core on deck, length 26,51 m, corer bent 12 m below top Departure to Station 14
18.05.2003	14	04:30				Survey around Station 14 Walton Basin
		06:21	17°46.99	077°53.18	513	On Station
		06:25				Begin operations for coring core MD03-2629
		06:57				Calypso Corer, tube length 43,70 m Trigger Core on deck, length 13,45 m , corer bent
18.05.2003	15	11:20	17°58.75	077°59.56	298	Arrival at Station 15 Walton Basin
		11:35				Begin operations for coring core MD03-2630 Giant Square Corer Accidental stopping of penetretion after 5 meters Core length: 1,87 meters

Date [UTC]	Station	Time [UTC]	Latitude N	Longitude W	Water depth[m]	Operations
18.05.2003	16	?	17°58.75	077°59.56	298	Decision: repeat operation same site Station 16 (repeat Station 15) Walton Basin Begin operations for coring core MD03-2631 Giant Square Corer Touchdown OK Core length 6,90 m Departure to Station 17
18.05.2003	17	19:40 19:45 20:26	17°51.17	078°48.64	1230	Arrival at Station 17 Walton Basin Begin operations for coring core MD03-2632 Calypso corer, tube length 32,50 m Trigger Core on deck, length 19,60 m Departure to Cozumel
END OF WALTON BASIN						
19.05.2003						Transit to Cozumel
21.05.2003						Arrival at Cozumel
21.05.2003		16:00				Departure from Cozumel Route to Exxon site n° 8 (27°24,138 N; 094°20.730 W)
22.05.2003						Route to Exxon site n°8
HUMPHREY'S BASIN, Begin EXXON-Program (not IMAGES)						
Cores MD03-2633 to MD03-2647 have been sampled as part of an EXXON-MOBIL contract, Not belonging to the IMAGES Program. However, the two following cores are open for paleoclimatic research under the responsibility of Laurent Labeyrie (LSCE, Gif-sur-Yvette)						
25.05.2003	26	19:00 19:14 19:51 21:00	27°17.35	094°25.90	1427	On Station 26 Humphrey's Basin Begin operation for core MD03-2641 Trigger Core on deck, core length 39,70 m
27.05.2003	28	05:42 05:48 06:02 06:31 07:30	27°22.32 N	094°19.83 W	1379	Station 28 Humphrey's Basin Begin operation, core MD03-2643 Begin lowering corer Trigger Core on deck, core length 42,05 m
END OF HUMPHREY'S BASIN						
27.05.2003		all day				Route to Miami
29.05.2003						Arrival at Miami

Date [UTC]	Station	Time [UTC]	Latitude N	Longitude W	Water depth[m]	Operations
29.05.2003		24				Departure from Miami
30.05.2003		all day				Route to Station 33
BLAKE PLATEAU AND CAPE HATTERAS						
31.05.2003		16:00				Arrive at point Bathy Begin survey for Blake Plateau site
31.05.2003	33	19:30				On Station 33
		19:40				Begin operations for coring MD03-2648
		19:55				Begin descent of Calypso corer
		20:17	33°10.55	076°15.365	950	Trigger
		21:00				Corer on deck, core length 40,36 m
31.05.2003	33 bis	22:50				Station 33 bis, gravity core MD03-2649
		23:00				Begin lowering the corer
		23:30	33°11.27	076°15.48	958	Touchdown
01.06.2003		00:10				Corer on board, core length 6,25 m
		00:20				plancton tow
		00:50				Depart from Station
01.06.2003	34	04:40				Survey for Station 34
		06:00				Station point chosen
		07:10				On Station 34
						Begin operations for coring MD03-2650
		07:22				Corer vertical, Calypso corer 44,50 m
		07:36	34°09.12	075°57.13	403	Trigger
		08:30				Corer on deck, core length 39,49 m
01.06.2003	34 bis					Wait for Station 34 bis
		09:30				On Station 34bis
		09:35				Begin operations for gravity core MD03-2651
		09:50	34°09.27	075°57.25	395	Touchdown
		10:30				Corer on deck, tube bent Core length 6.40 m Prepare for station 35
01.06.2003	35	11:50				On Station 35
		11:55				Begin operations for gravity core MD03-2652
		12:00				Descent corer
		12:09	34°08.15	075°56.18	426	Touchdown

Date [UTC]	Station	Time [UTC]	Latitude N	Longitude W	Water depth[m]	Operations
						Corer on deck, core length 13,13 m Depart for Station 36
01.06.2003	36	17:10				Station 36 (Cape Hatteras) Multibeam profile of the coring site area (3 hours)
		20:00				On Station
		20:50				Begin coring giant square core MD03-2653
		21:03	34°58.62	075°11.99	603	Touchdown
		22:15				Core on deck, core length 11.07 m End of Station
						Depart to Pilot place for Chesapeake Bay

CHESAPEAKE BAY

02.06.2003		08:00				Pilot Chesapeake Bay on board
	37	14:08				Approach to Station 37, Core MD03-2654
		14:35	37°18.75	075°06.25	20	On Station Ship Anchored
		15:02				Change anchored position (corer at right location)
		15:34				Corer vertical
		15:51				Trigger
		16:25				Corer on board, bent, core length 9,73 m Move to Station 38
02.06.2003	38	19:00	37°43.34	075°56.32	16.5	On Station 38, core MD03-2655
		19:15				Anchor dropped
		19:28				Corer vertical
		19:46				Trigger
		20:05				Corer on board, core length 13.04 m
		20:15				Move to station 39
02.06.2003	39	20:35	37°43.25	075°56.44	16	Station 39 (200 m from Station 38)
		20:48				Ship anchored
		21:44				Begin operations for coring MD03-2656
		21:49				Corer vertical
		22:05				Trigger
		22:35				Core on deck, length of core:
02.06.2003	40	23:20				On site at Station 40
		23:39				Ship anchored
03.06.2003		00:13				Begin lowering gravity core MD03-2657
		00:15	37°40.72	75°59.17	13.9	Touchdown
						Small penetration, core length 2,49 m

Date [UTC]	Station	Time [UTC]	Latitude N	Longitude W	Water depth[m]	Operations
03.06.2003	41	02:37				Arrival on Station 41
		02:40				Begin coring gravity core MD03-2658
		02:54	37°40.72	076°00.53	14.55	Touchdown
		03:30				Core on deck, core length 0.83
						Depart for Station 42
03.06.2003	42	06:02	38°01.83	076°13.06	27	On Station 42 (CH.B. #5,6, Mid Bay Potomac River)
		06:29				Ship anchored
		06:33				Begin operations for coring calypso core MD03-2659
		06:55				Corer vertical
		7:08/50				Trigger Core on board, core length 19,67 m
03.06.2003	42 bis	09:21	38°01.82	076°13.07	27.2	Station 42 bis, same as 42
		10:00				Corer vertical for calypso Corer MD03-2660
		10:16				Trigger
		10:50				Corer on board, core length 20,15 m Depart to station 43
03.06.2003	43	16:15				Arrival on Station 43
		16:34				Ship anchored
		16:46				Begin operations for coring MD03-2661
		17:04	38°53.21	076°23.89	25.5	Trigger
		17:30				Corer on deck, core length 24,48 m
13:57				Depart to Station 44		
03.06.2003	44	19:50				Arrival on Station 44
		19:58				Ship anchored
		20:07				Begin operations for coring gravity core MD03-2662
		20:10				Corer vertical
		20:14	38°50.12	076°23.87	45	Touchdown
		20:45				Core on deck, core length 0,89 m Depart to Station 45
03.06.2003	45	23:52				Arrival on Station 45
		23:54				Ship anchored
04.06.2003		00:06				Begin operations for coring calypso core MD03-2663
		00:10				Corer vertical
		00:26	38°21.50	076°19.25	37	Trigger
		00:48				Corer on deck, core length 17,00 m

END OF CHESAPEAKE BAY

Date	Station	Time	Latitude	Longitude	Water	Operations
[UTC]		[UTC]	N	W	depth[m]	
BALTIMORE						
04.06.2003		09:00				Arrival at Baltimore Harbour
05.06.2003		09:30				Visit of the 8th grade students from the
		11:30				Key School of Annapolis, Maryland
END OF BALTIMORE						
06.06.2003		00:00				Departure from Baltimore
07.06.2003	46	21:30	40°50.48	066°38.53	0-50	CTD Plancton tow 20 min
08.06.2003						Route all day
09.06.2003	47	21:35	45°59.49	054°07.40	0-50	CTD Plancton tow 20 min
11.06.2003	47 bis	12:15	54°14.75	049°14.50	0-100	CTD 0-100m Plancton tow, 20 min at 20m
EIRIK DRIFT						
12.06.2003	48	02:46				Approach Station 48
		03:02				On Station
		03:04				Begin operations for coring calypso core MD03-2664
		03:19				Corer vertical
		03:30				Begin descent corer
		04:32	57°26.57	048°36.59	3440	Trigger
		05:50				Corer at surface Core length 35,07 m
						Stay on station for Giant Square Corer
	48	08:15				Ready for lowering CASQ MD03-2665
		08:18				Begin operations
		08:20				Corer vertical
		08:23				Begin descent corer
		09:21	57°26.56	048°36.60	3440	Touchdown
		11:00				Corer on board Core legth 11,18 m Departure from Station 48
12.06.2003	49	15:00				Survey for Station 49
		16:21				On Station

Date [UTC]	Station	Time [UTC]	Latitude N	Longitude W	Water depth[m]	Operations
		16:38				Begin operations for coring Calypso core MD03-2666
		16:40				Corer vertical
		16:49				Begin lowering corer
		17:44	58°12.96	048°19.73	3442	Trigger
		19:40				Core on deck, core length 38,89 m Stay on station for gravity core
	49	21:12				Begin operations for coring gravity core MD03-2667
		21:20				Begin descent corer
		22:17	58°12.96	048°19.73	3442	Touchdown
		23:30				Core on deck, core length 10,83 m Departure for Station 50
13.06.2003	50	04:13				Begin survey for Station 50
		05:10				On Station 50
		05:35				Begin operations for corign Calypso core MD03-2668
		05:39				Corer vertical
		05:50				Begin descent corer
		06:36	58°40.86	046°51.39	2653	Trigger
		08:00				Corer on deck, core legth 37,66 m Stay on station for gravity core
	50	09:23				Begin lowering corer for MD03-2669
		10:07	58°40.86	046°51.37	2653	Touchdown
		11:01				Surface Corer on deck, core length 11,62 m
	50	11:38	58°40.86	046°51.37	2653	CTD 0-100 m
		11:55				plancton tow 20 min at 40 m
13.06.2003		00:25				Departure from Station
13.06.2003	51	17:20				Begin survey for station 51
		17:50				On Station
		17:58				Begin operations for coring Calypso corer MD03-2670
		18:02				Corer vertical
		18:10				Begin lowering corer
		18:49	58°35.92	044°57.15	1978	Trigger
		20:15				Corer on deck, core length 37,88 m Stay on Station for Giant Square Corer (CASQ)
	51	20:45				Begin operations for CASQ MD03-2671
		21:15				CASQ horizontal along board
		21:45				CASQ vertical
		21:48				Begin lowering corer
		22:21	58°35.94	044°57.20	1978	Touchdown

Date [UTC]	Station	Time [UTC]	Latitude N	Longitude W	Water depth[m]	Operations
		23:10				Corer on board, core length 10,97 m
		23:50				Depart from Station 51
END OF EIRIK DRIFT						
Reykjanes Ridge						
15.06.2003	52	12:30				Begin survey for Station 52
		15:02				On Station
		15:03				Begin operations for coring gravity core MD03-2672
		15:06				Corer vertical
		15:10				Begin descent
		15:39	59°04.42	031°28.45	1681	Touchdown
		16:40				Corer on surface, core length 7,84 m
						Stay on Station for CTD and plancton tow
		16:50			0-100	CTD ready
		16:51	59°04.42	031°28.45		Begin descent to 100 m
		17:25				plancton tow at 21-22m, 1.6 knots
		17:56				Depart from station 52
GARDAR DRIFT						
16.06.2003	53	07:10				Begin survey for station 53
		08:20				Point chosen
		09:50				On station 53
		09:58				Begin operations for coring Calypso core MD03-2673
		10:11				Begin lowering corer
		10:58	56°21.91	027°48.86	2829	Trigger
		12:35				Corer on board, length of core 39,05 m
						Stay on Station for CTD and CASQ
		13:29			0-100	CTD
		13:52				End of CTD
		14:00				CASQ MD03-2674 ready to go
		14:15				Begin lowering corer
		15:03	56°21.91	027°48.86	2829	Touchdown
		16:45				Core on deck, core length 11,85 m
		17:00				Begin plancton tow
		17:30				End of plancton tow
						Depart from Station
16.06.2003	54	22:20				Begin survey for Station 54
		22:50				Point chosen

Date [UTC]	Station	Time [UTC]	Latitude N	Longitude W	Water depth[m]	Operations
		23:15				On Station 54
		23:20				Begin operations for coring Calypso core MD03-2675
		23:33				Begin lowering corer
17.06.2003		00:17	57°26.84	027°54.53	2607	Trigger Most probably overpenetration
		01:20				short winch failure
		02:00				Corer on board, core length 36,00 m Stay on station for CASQ
17.06.2003		03:25				Begin operations for coring CASQ MD03-2676
		03:32				Begin descnet corer
		04:15	57°26.86	027°54.52	2607	Touchdown
		05:39				Corer on deck, core length 11,88 m
		05:50				Depart from station 54
17.06.2003	55	13:15				Begin survey for station 55
		14:10				Point chosen
		15:20				On station 55
		15:21				Begin operations for coring Calypso core MD03-2677
		15:39				Begin lowering corer
		16:28	58°45.74	025°57.53	2606	Trigger (most probably overpenetration) Corer on deck, core length 36,02 m Stay on station for CASQ
17.06.2003		19:30				Begin operations for coring CASC core MD03-2678
		19:35				Begin lowering the corer
		20:18	58°45.74	025°57.55	2603	Touchdown (at 2610)
		21:34				Corer on deck, length of the core 11,53 m
		21:45				Depart from Station 55
18.06.2003	56	06:50				Begin survey for Station 56
		08:25				Point chosen
		09:39				On Station
		09:41				Begin operations for coring calypso core MD03-2679
		10:00				Begin descent of the corer
		10:38	61°03.42	024°32.46	1812	Trigger (at 1770)
		12:05				Corer on deck, core length 35,37 m Stay on station for CASQ
		13:47				Begin lowering corer for CASQ MD03-2680
		13:48				Floater in place
		14:18	61°03.40	024°32.42	1812	Touchdown (at 1810)
		14:56				Surface
		15:29				Corer on deck, core length 10,96 m
		16:15				Depart from Station 56

Date [UTC]	Station	Time [UTC]	Latitude N	Longitude W	Water depth[m]	Operations		
18.06.2003	57	17:30				Begin survey for Station 57		
		18:18				Site chosen		
		19:18				On Station		
		19:22				Begin operations for coring calypso core MD03-2681		
		19:39				Begin descent of corer (top zero)		
		20:11	61°22.75	024°08.12	1658	Trigger		
		21:19				Corer on deck, core length 37,75 m Stay on station for gravity core		
		57	22:45			Begin descent of corer		
			22:13			Begin operations for coring gravity core MD03-2682		
	19.06.2003		23:15	61°22.72	024°08.12	1659	Touchdown (at 1664)	
		23:53				Surface		
		00:15				Core on deck, core length 4,60 m Stay on Station for CTD and plancton tow		
		00:30			0-100	CTD		
		00:55			30	plancton tow 20 min		
		01:35				plancton net on deck Depart from station 57		
19.06.2003		58	05:45				Begin survey for Station 58	
	06:51					Site chosen		
	08:12					On Station 58		
	08:13					Begin operations for coring gravity core MD03-2683		
	08:18					Corer vertical		
	08:24					Begin descent corer		
	08:54		60°24.07	023°38.34	1979	Touchdown		
	09:36					Corer on surface		
							Corer on deck, length of the core 7,87 m Stay on station for CASQ	
				10:30			Begin operations for coring CASQ MD03-2684	
				10:49			Begin descent corer	
				11:17	60°24.08	023°38.39	1979	Touchdown
				12:28			Corer on board, core length 11,30 m Stay on station for calypso core	
				14:00			Begin operations for coring Calypso core MD03-2685	
				14:26			Begin descent corer	
		15:04	60°24.08	023°38.39	1977	Trigger		
		16:35			Corer on deck, core length 44,61 m			
		16:45			Depart from Station 58			

END of GARDAR DRIFT

Date	Station	Time	Latitude	Longitude	Water	Operations
[UTC]		[UTC]	N	W	depth[m]	
FENI DRIFT						
20.06.2003	59	19:00				Begin survey for station 59
		20:00				Site chosen
		20:45				On station 59
		20:50				Begin operations for coring calypso core MD03-2686
		21:07				Begin descent (top zero)
		21:46	55°29.11	014°42.01	2162	Trigger
		23:01				Corer on deck, core length 36,61 m Stay on station for CASQ
21.06.2003	59	00:00				Beginning operations for coring CASQ MD03-2687
		00:42				Begin descent of corer (top zero)
		01:19	55°29.11	014°41.99	2162	Touchdown
		01:45				Corer on deck, core length 11,05 m Stay on station for CTD
		02:05	55°29.11	014°41.99	0-100	CTD profile
		02:28				End of CTD
		03:40				plancton tow at 17 m
		04:00				End of plancton tow.

END OF P.I.C.A.S.S.O.

1.3 Core Positions and Repository Information

Station	Core	Water depth [m]	Site name	Latitude ° N	Longitude ° W	Core length [m]	PI	Repository	
								W	A
1	MD03-2616	1233		07°48.75	053°00.80	39.33	J. Grimalt	1(7)	1(7)
2	MD03-2617	1842		10°23.10	058°50.66	33,38	E. Gonthier	2	2
3bis	MD03-2618	1665	Pilar Area	11°11.33	059°13.76	36.48	L. Labeyrie	1	1
4	MD03-2619	949	Cariaco Basin	10°03.95	064°54.80	43.04	J. Thurow	3	3
5	MD03-2620	876	Cariaco Basin	10°39.05	065°10.17	49.93	G. Haug, L. Peterson	4	5
6	MD03-2621	847	Cariaco Basin	10°40.69	064°58.29	52.97	G. Haug, L. Peterson	4	5
7	MD03-2622	877	Cariaco Basin	10°42.37	065°10.15	48.30	G. Haug, L. Peterson	4	5
8	MD03-2623	949	Cariaco Basin	10°39.06	064°54.75	56.43	J. Thurow	3	3
9	MD03-2624C2	850	Cariaco Basin	10°40.65	064°58.24	08.08	G. Haug, L. Peterson	4	5
10	MD03-2625C2	847	Cariaco Basin	10°40.65	064°58.24	05.08	G. Haug, L. Peterson	4	5
11	MD03-2626G	1332	Cariaco Basin	10°49.39	065°21.31	09.13	L. Peterson, G. Haug	4	5
12	MD03-2627	2991	Colombian Sea	15°43.30	075°01.93	39.57	Joan Grimalt	1	1
13	MD03-2628	846	Walton Basin	17°21.62	077°42.45	26.51	<i>PI's for all Walton-Basin cores: L. Labeyrie, E. Bard, A. Droxler</i>	1	1
14	MD03-2629	513	Walton Basin	17°46.99	077°53.18	13.45		1	1
15	MD03-2630C2	298	Walton Basin	17°58.75	077°59.56	01.87		1	1
16	MD03-2631C2	291	Walton Basin	17°58.75	077°59.56	06.90		1	1
17	MD03-2632	1231	Walton Basin	17°51.17	078°48.64	19.60	A. Droxler	1	1
26	MD03-2641	1427	Humphrey's Basin	27°17.35	094°25.90	39.70	L. Labeyrie/de Abreu	1	1
28	MD03-2643	1379	Humphrey's Basin	27°22.32	094°19.83	42.05	L. Labeyrie/de Abreu	1	1
33	MD03-2648	950	Blake Plateau	33°10.55	076°15.36	40.36	L.L. Labeyrie	1	1
33	MD03-2649G	958	Blake Plateau	33°11.27	076°15.48	06.25	L.L. Labeyrie	1	1
34	MD03-2650	403	Blake Plateau	34°09.12	075°57.13	39.49	L. Labeyrie	1	1
34	MD03-2651	395	Blake Plateau	34°09.27	075°57.25	06.40	L. Labeyrie	1	1
35	MD03-2652G	426	Blake Plateau	34°08.15	075°56.19	13.13	L. Labeyrie	1	1
36	MD03-2653C2	593	Cape Hatteras	34°58.62	075°11.99	11.07	L. Labeyrie	1	1
37	MD03-2654	22.8	Cape Charles City	37°18.76	076°06.17	09.73	D. Willard	6	6
38	MD03-2655	16	Pocomoke	37°43.34	075°56.32	13.05	J. Pohlman	6	6
39	MD03-2656	16.3	Pocomoke	37°43.25	075°56.51	16.00	D. Willard	6	6
40	MD03-2657G	13.9	Pocomoke LIG	37°40.79	075°59.17	02.49	D. Willard	6	6
41	MD03-2658G	14.5	Pocomoke LIG	37°40.74	076°00.54	00.83	D. Willard	6	6
42	MD03-2659	27	Mid-Bay Potomac	38°01.83	076°13.06	19.67	D. Willard	6	6
42	MD03-2660	27.2	Mid-Bay Potomac	38°01.83	076°13.07	20.15	J. Pohlman	6	6
43	MD03-2661	25.5	Kent Island Shallow	38°53.21	076°23.89	24.48	D. Willard	6	6
44	MD03-2662G	45	Kent Island Deep	38°50.12	076°23.87	00.89	D. Willard	6	6
45	MD03-2663	37	Patuxent Site 1A	38°21.50	076°19.25	17.00	D. Willard	6	6
48	MD03-2664	3440	Eirik Drift	57°26.57	048°36.59	35.07	C. Kissel	1	1
48	MD03-2665C2	3440	Eirik Drift	57°26.56	048°36.60	11.18	C. Kissel	1	1
49	MD03-2666	3442	Eirik Drift	58°12.96	048°19.73	38.89	C. Kissel	1	1
49	MD03-2667G	3442	Eirik Drift	58°12.96	048°19.73	10.83	C. Kissel	1	1
50	MD03-2668	2653	Eirik Drift	58°40.86	046°51.39	37.66	C. Kissel	1	1
50	MD03-2669G	2653	Eirik Drift	58°40.86	046°51.37	11.62	C. Kissel	1	1
51	MD03-2670	1978	Eirik Drift	58°35.92	044°57.15	37.88	C. Kissel	1	1
51	MD03-2671C2	1978	Eirik Drift	58°35.94	044°57.20	10.97	C. Kissel	1	1
52	MD03-2672G	1681	Reykyanes Ridge	59°04.42	031°28.45	07.84	C. Kissel	1	1
53	MD03-2673	2829	Gardar Drift	56°21.91	027°48.86	39.05	C. Kissel	1	1
53	MD03-2674C2	2829	Gardar Drift	56°21.91	027°48.86	11.85	C. Kissel	1	1
54	MD03-2675	2607	Gardar Drift	57°26.84	027°54.53	36.00	C. Kissel	1	1
54	MD03-2676C2	2607	Gardar Drift	57°26.86	027°54.52	11.88	C. Kissel	1	1

Station	Core	Water depth [m]	Site name	Latitude ° N	Longitude ° W	Core length [m]	PI	Repository	
								W	A
55	MD03-2677	2606	Gardar Drift	58°45.74	025°57.53	36.02	C. Kissel	1	1
55	MD03-2678C2	2603	Gardar Drift	58°45.74	025°57.55	11.53	C. Kissel	1	1
56	MD03-2679	1812	Gardar Drift	61°03.42	024°32.46	35.37	C. Kissel	1	1
56	MD03-2680C2	1812	Gardar Drift	61°03.40	024°32.42	10.96	C. Kissel	1	1
57	MD03-2681	1658	Gardar Drift	61°22.75	024°08.12	37.75	C. Kissel	1	1
57	MD03-2682G	1659	Gardar Drift	61°22.72	024°08.12	04.60	C. Kissel	1	1
58	MD03-2683G	1979	Gardar Drift	60°24.07	023°38.34	07.87	C. Kissel	1	1
58	MD03-2684C2	1979	Gardar Drift	60°24.08	023°38.39	11.30	C. Kissel	1	1
58	MD03-2685	1977	Gardar Drift	60°24.08	023°38.39	44.61	C. Kissel	1	1
59	MD03-2686	2162	Feni Drift	55°29.11	014°42.01	36.61	C. Kissel	1	1
59	MD03-2687C2	2162	Feni Drift	55°29.11	014°41.99	11.05	C. Kissel	1	1

Repository index :

1. LSCE/CNRS, Gif-Sur-Yvette, France
2. University of Bordeaux-1, France
3. British Ocean Sediment Core Repository (BOSCOR), Southampton, UK
4. University of Miami Core Repository, USA
5. GFZ Potsdam, Germany
6. USGS Core Repository, Reston, USA
7. University of Barcelona, Spain

1.4 CTD Positions

Date	Station	CTD n°	Reference	Profile	Latitude °N	Longitude °W
27.05.2003	31	1	De271440	0-100 m	27°18.62	094°24.70
01.06.2003	33 bis	2	Df012130	0-100 m	33°11.27	076°15.48
08.06.2003	46	3	Df081700	0-100 m	40°50.48	066°38.53
10.06.2003	47	4	Df101730	0-100 m	45°59.49	054°07.40
12.06.2003	47bis	5	Df121230	0-100 m	54°14.75	049°14.50
14.06.2003	50	6	Df140830	0-100 m	58°40.58	046°52.00
16.06.2003	52	7	Df161430	0-100 m	59°04.79	031°28.71
17.06.2003	53	8	Df171130	0-100 m	56°21.89	027°48.94
20.06.2003	57	9	Df200030	0-100 m	61°23.00	024°06.51
22.06.2003	59	10	Df220300	0-100 m	55°28.85	014°41.72

1.5 Plankton Net Hauls

Latitude	Longitude	Op. Depth	Salinity	Surf. Temp	Direktion [°]	Speed [kn]	Drift EW	Drift NS
27°21,21N	094°24,24W	69m	32.69 ‰	27.10 °C	200.00	1.7 kn	W, 5cm/s	S, 10cm/s
33°12,62N	076°15,82W	56m	36.26 ‰	26.27 °C	308.00	1.5 kn	E, 20 cm/s	S, 15 cm/s
35°00,35N	075°10,79W	55m	35.53 ‰	24.60 °C	231.2 (14.9 fd)	3.1kn	E, 20 cm/s	N, 30 cm/s
40°50,28N	066°38,94W	59m	34.77 ‰	17.30 °C	84.60	2.1kn	W,8cm/s	N,10 cm/s
45°59,72N	054°07,11W	36m	32.60 ‰	3.79 °C	59.40	2.1kn	W, 28 cm/s	S, 30 cm/s
54°15,10N	049°14,30W	25m	34.67 ‰	6.30 °C	17.50	2.2 kn	E, 10 cm/s	S 15 cm/s
58°40,46N	046°51,72W	49m	34.37 ‰	5.90 °C	111.80	2.0 kn	E 1cm/s	S 10 cm/s
59°05,82N	031°29,51W	21m	35.07 ‰	9.70 °C	?	1.6 kn	E 80cm/s	N 130 cm/s
56°22,19N	027°47,98W	20m	35.02 ‰	10.72 °C	354.00	1.9 kn	W 6 cm/s	S 5 cm/s
61°22,54N	024°09,34W	30m	35.24 ‰	11.05 °C	200.00	1.8 kn	W 5 cm/s	S 2 cm/s
55°27,84N	014°42,03W	17m	35.39 ‰	12.63 °C	300.00	1.8 kn	W 8cm/s	S 30 cm/s

1.6 Lists of Cruise Participants: Scientists, Crew, Malagasian Team, Cheeses

1.6.1 The Scientific Party

Name	Surname	Organisation/University
ALVAREZ ZARIKIAN	Carlos	University of Miami
ANDRIEUX	Marc	TAAF
APARICIO	Ruben	Venezuelian Observer
BALLINI	Marine	LSCE
BALUT	Yvon	IPEV
BERNHARDT	Christopher	US Geological Survey
BERTRAND	Sébastien	Université de Liège
BLANCHARD-BELLOUD	Anne	Medical Doctor
BOES	Xavier Bernard	Université de Liège
BRACHFELD	Stéphanie	Ohio State University
BUJAN	Stéphane	Université de Bordeaux 1
CETIN	Fetihye	LSCE
CHESHIRE	Heather	University College London
COLMENERO HIDALGO	Elena	Universidad de Salamanca
CRONIN	Thomas	US Geological Survey
DE DECKER	Sophie	Université de Bordeaux 1
DESSALE	Nils	INTECHMER
DIRBERG	Guillaume	Université de Bordeaux 1
DROXLER	André	Rice University
FLORES	José-Abel	Universidad de Salamanca
GALLO	Gilbert	IPEV
GODEFROY	Stéphanie	LSCE
GUILLEMIN	Marie-Thérèse	LSCE
HADOUX	Valérie	IPEV
HALL	Jenney	Yale University
JAOUEN	Alain	IPEV
KISSEL	Catherine	LSCE
KLEIVEN	Helga	University of Bergen
LABEYRIE	Laurent	LSCE / CEA
LAJ	Carlo	LSCE
LE MEUR	Géraldine	INTECHMER
LEBOURG	Laurence	IPEV
LOCKWOOD	Rowan	College of William and Mary
LOPEZ-MARTINEZ	Constancia	CSIC
MALENGROS	Deny	Université des Sciences et Technologies de Lille
MALLARINO	Gianni	Rice University
MANLEY	Patricia	Middelbury College
MAROT	Margaret	US Geological Survey
MAZAUD	Alain	LSCE
McCONNELL	Martha	University of South Carolina
MECKLER	Anna Nele	ETH, Zurich
MELLET	Martin	IPEV
MILLO	Christian	University of Kiel
MINGRAM	Jens	GeoForschungsZentrum Postdam
MORIN	Xavier	IPEV
NEWELL	Wayne	US Geological Survey

Name	Surname	Organisation/University
NOWINSKI	Aurélie	Norwegian Polar Institute, Tromso
OLLIVIER	Bernard	IPEV
OLSON	Brooke	Rice University
PERRIQUET	Marie	Université de Bordeaux 1
PETERSON	Larry Curtis	University of Miami
POHLMAN	John	US Naval Research Laboratory
REBOLLEDO-VIEYRA	Mario	LSCE
RIBOULLEAU	Armelle	Université des Sciences et Technologies de Lille
RICHTER	Thomas	Royal Netherland Institute for Sea Research
RIGAUT	Frédéric	IPEV
ROTHE	Stefan	IMAGES Office, at the University of Kiel
ROUSSE	Sonia	LSCE
ROUSSET	Jean-Marc	Université de Caen
SAENGER	Casey	USGS
SAMUEL	Claire	INTECHMER
SANGIARDI	Pierre	IPEV
SCAO	Vincent	LSCE
SHAH	Anjana	US Naval Research Laboratory
SHEEHAN	Thomas	US Geological Survey
SIERRO	Francisco	Universidad de Salamanca
SMITH	Russell Tyler	Rice University
TACHIKAWA	Kazuyo	CEREGE
TANG	Jennifer	Rice University
THUROW	Juergen	University College London
VOGT	Peter	US Naval Research Laboratory
WADSWORTH	Emilie	University of St. Andrews, Scotland
WALKER	James	Rice University
WILLARD	Debra	US Geological Survey

1.6.2 The Crew of R/V “Marion Dufresne”

Name	Surname	Function on Bord
LEFEVRE	Jean Marc	Captain
CONSEIL	Herve	1. Officer
LE CUNF	Cedric	1. Officer
SOTON	Jean Francois	1. Engineer
PHILIPPE	Yannick	1. Engineer
MARTIN	Sebastien	2. Engineer
BLOT	Guilhem	2. Officer
SIEGWALD	Jerome	Radio Officer
ROY	Henry	Radio Officer
VIGOUROUX	Nicolas	Polyvalent Officer
DE FRANCO	Delphine	Polyvalent Officer
LETOURNEL	Antoine	Polyvalent Officer
HOULY	Ivan	Officer Cadet
COLIN	Eric	Mechanic
ROLLANDO	Georges	Electrician
CAPARD	Jean Claude	Maitre Hotel, Chief Steward

Name	Surname	Function on Bord
MERLEN	Vincent	Mechanic
CROUZET	Nicolas	Mechanic
LALLEMAND	Mickael	Mechanic
LAUTRAM	Marcel	Electrician
CONNAN	Christophe	Chief Cook
LE DREAU	Jean Marc	Quartermaster
COLIN	Paul	Quartermaster
BURGUIN	Guenael	Quartermaster
LATCHIMY	Jean Louis	Quartermaster
YEVE	Charles	2. Quartermaster
NIVELLE	Philippe	2. Quartermaster
PHILIPPE	Alban	2. Quartermaster/Electrician
FADY	Thierry	Kitchen
BOOT	Walter	Steward
COMBE	Francois	Steward
CONTENA	Bruno	Steward
HAMON	Daniel	2. Cook

1.6.3 The Malagasian Team of R/V “Marion Dufresne”

Name	Surname	Function on Bord
JAOSAO	Bakary	Worker
TELOHALY	Gervais	Worker
MADI	Ali	Worker
TOTOMENA	Jaques	Worker
ALFRED		Worker
BERTHIN (J)	Jose	Worker
MANESY	Jean Eloi	Worker
RAJAOBELINA	Philippe	Worker
LAZANIAINA	Jaques An	Worker
RATOVONASY	Michel	Worker
RANDRIANANDR	Richard	Worker
RAFANOHARAN	Jean Luc	Worker
CHAN KA SING	Jean De Die	Worker
GASTON	Narcisse Mari	Worker
LETODY	Etienne	Worker
RAKOTOARIMA	Thierry	Worker
RAKOTONINDRI	Roger	Worker
BERTHIN		Worker
RAFANOHARAN	Rodolphe	Worker
RAJAONARIVO	Seth	Worker
BAKO	Bruno	Worker
BABA CARDIA	Sulleman	Worker

2. Coring and Sampling Methods, Core Handling

2.1 CORING

Piston Cores: Most of the cores, taken during cruise, are piston cores. The Calypso piston corer, developed on board Marion Dufresne, can be fitted with a tube up to 75 m in length. The corer is deployed with an Aramide cable, virtually weightless in water, which significantly enhances the traction security margin and weight lifting capacity of the winch.

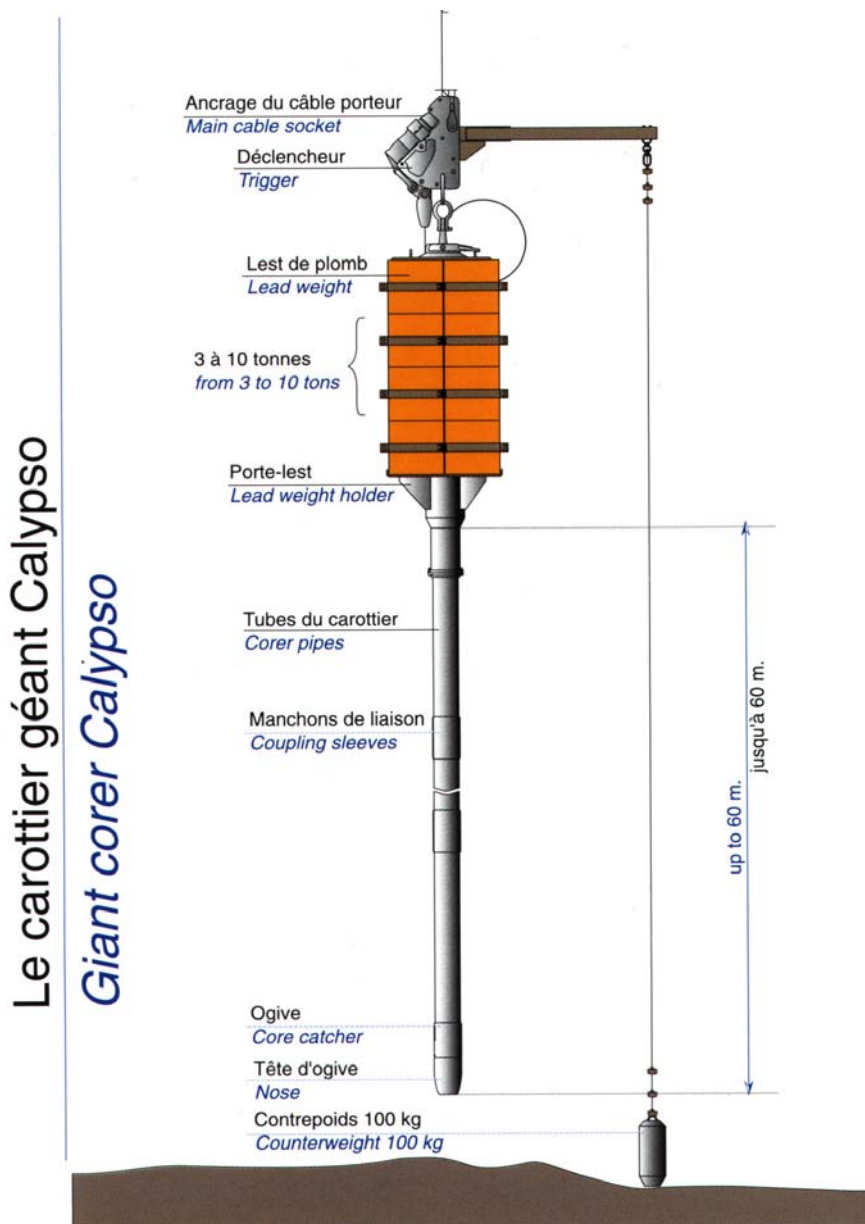

Fig. 3: Calypso piston coring system

Gravity Cores: At some sites, gravity cores were taken in addition to the regular piston cores. The tube used for gravity cores was the same then the one used for Piston coring, just shorter and without the triggerarm.

Calypso Square Cores: The calypso square-core system combines the piston coring mechanism of the calypso system with the huge core dimensions (25 * 25 cm) of a box corer. Cores, gained with this system reached lengths up to twelve meters and acquired a huge amount of sediment. Particularly these cores contained a nearly undisturbed core top with very few sediment missing, and the large surface of the opened core allowed improved studies of structures and textures. Thus, these cores were described before segments were cut.



Fig 4: The calypso square-core system.

Left photo: CASQ attached to the starboard side of the ship.

Right Photo: prominent change in sediment color at 5m sediment depth, as illustrated by the chief scientist's hand

2.2 CORE HANDLING (Catherine Kissel)

2.2.1 Calypso and Gravity Cores

In preparation for the core, drill small holes into the center of 40 round endcaps. The core handling tools: pipe cutters, fishing line, sponges, paper towels, razor knife, grey tape, tape measure, black marking pens are assembled.

When the core is secured on deck of the ship, the core catcher is unscrewed and the sediment that it contains is collected in a plastic bag. Label the plastic bag with the cruise ID and core number and "core catcher." With the help of the crew, the liner is removed from the metallic pipe and the height to which the liner is filled with sediment is determined. This is done by gently tapping on the liner and listening for a change from a hollow noise to a full pipe noise. A pipe cutter is used to cut the liner at the top of the sediment. As the sediment is likely to be water-rich, the first labeled endcap for the top (0 cm) of the core is ready. The length of the core is measured and noted on the description form. After the liner has been well cleaned and dried, a mark is drawn every 1.5 m. This mark denotes the section breaks, and is a guideline for cutting the liner. Each 1.5 m section is labelled on both sides with:

- the core number ("G" is added at the end of the core number for gravity cores),
- section number in roman numbers (I is the first one at the top of the core),
- A or W (circled), (W when the writer is facing the ship, A when the writer is facing the sea)
- T x (=Top x cm) and B y (bottom Y cm).

The labels should be written far enough away from the section breaks so that the label will not be covered by the endcaps. Similarly, the label should be far enough away from the reference line to leave room for the metric tape. The sketch below illustrates the labeling:

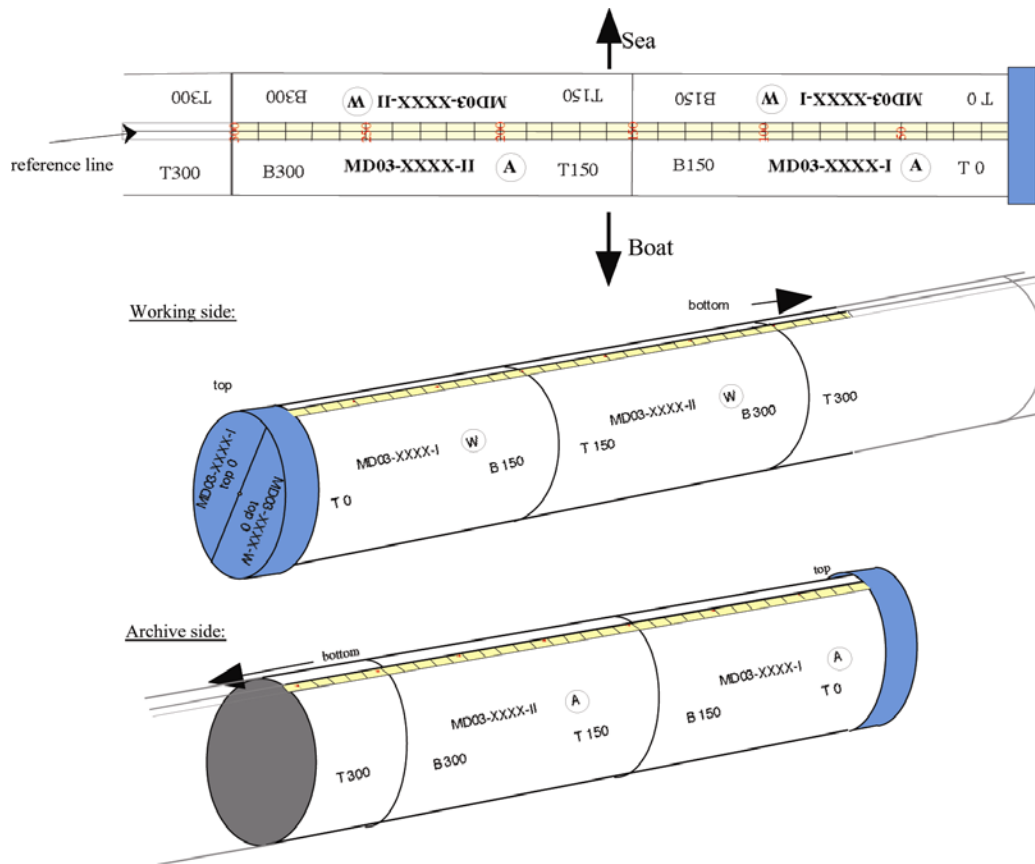

Fig. 5: Sketch of the labelling of CALYPSO (piston) and gravity cores

A diameter line is drawn across every endcap to divide them into equal half circles. One half circle is labeled with the number of the core and section, T or B and the cm, and A for archive. The other half is labeled with the number of the core and section, T or B and the cm, and W for working. The line separating the two halves of the caps is aligned with the reference line on the liner. The core is cut into sections of 1.5 m length, following the guide marks.

For each section the cap is removed and an adhesive metric tape is stuck on the liner, on top of the reference line. Depths in cm are written on both halves every 20 cm, continuously all along the core, starting at 0 cm at the top. The metric tape is applied continuously on the sections. If section N is shorter than 150 cm, then the extra 1 cm of metric tape from section N is stuck at the top of section N+1 (see figure)

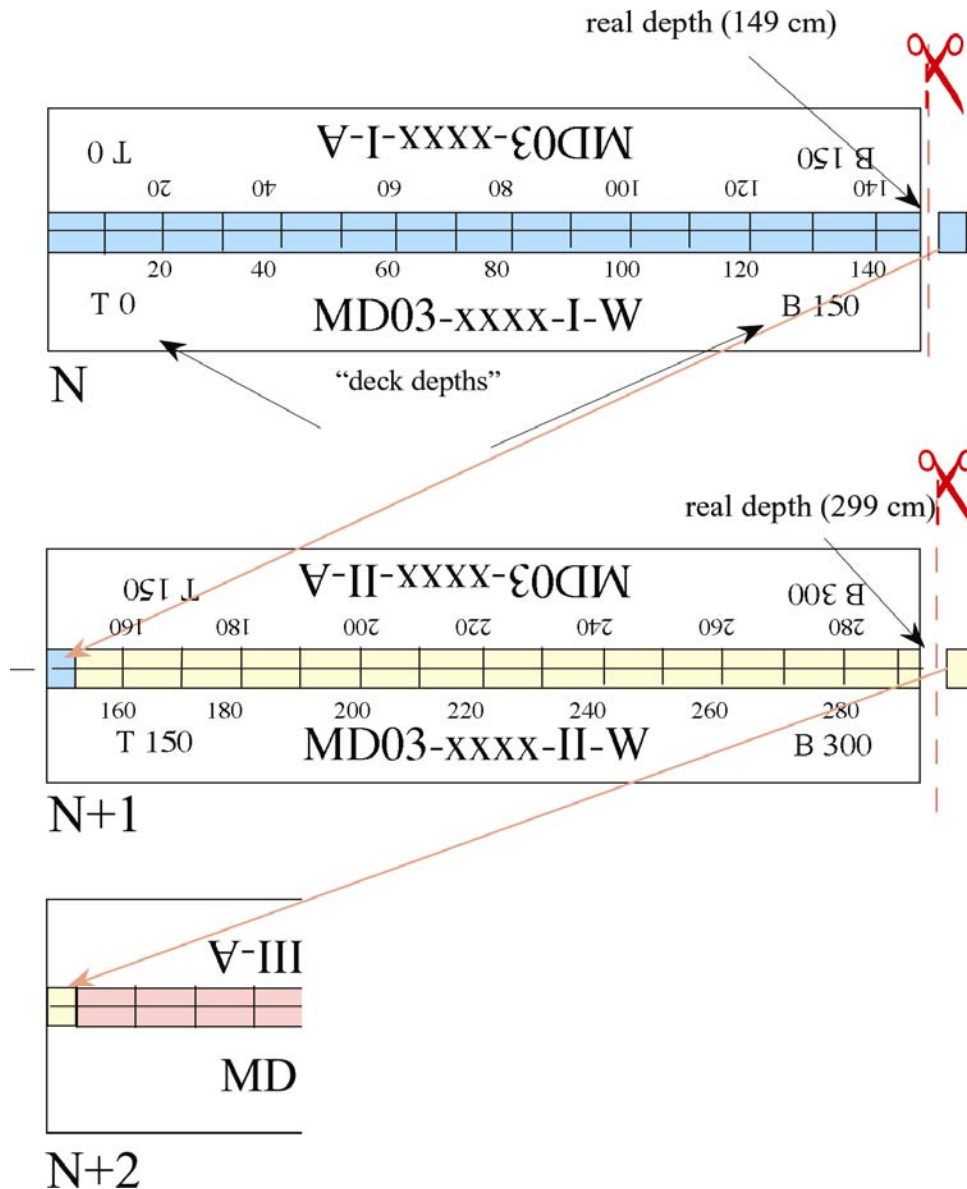

Fig. 6: Adjusting the measuring tape when dealing with uneven section lengths

The caps are put back on and fixed with heavy tape so that each half cap is in correspondance with the respective half core

Each section is split into two halves, the working and archive halves, with the cut made along the reference line, the archive half on top. After splitting the liner, use a razor knife to cut each endcap along the diameter line. The sediment from the two halves is separated by passing a fishing line between the two halves of the liner. The surface of the sediment is cleaned and covered with a plastic film. The working half is sent to the description, spectrophotometer, photo, MST track and then packed. The archive half is packed immediatly.

The packing consists of covering the section with plastic film, then inserting the section into a long plastic bag with tie knots in both ends. The section is then placed inside a D-tube. The D-tubes are labeled with the cruise ID and core number, section number, in the same way that the core itself is labeled. In addition, T x cm and B y cm is written on the D-tube and on each endcap as appropriate (see figure below). The section is inserted so that the top of the core is at the T end of the D-tube and the bottom of the section is at the B end. Both archive and working halves are stored in cold containers.

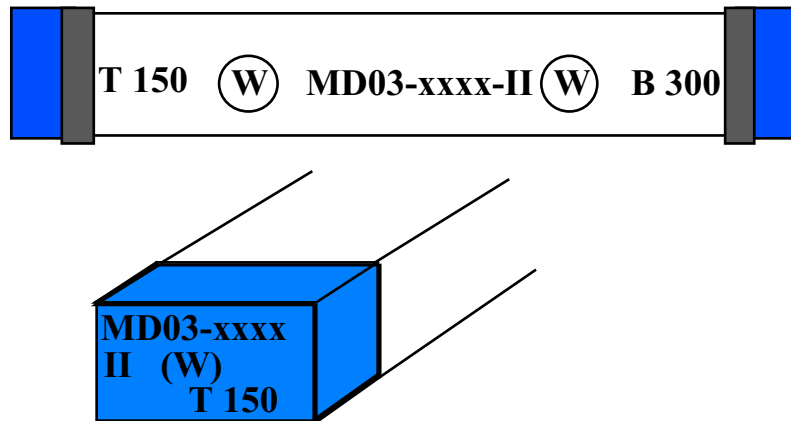

Fig.7: Labelling of the D-tubes before they are stored in the container

2.2.2 CASQ Cores

The lid of the corer is unbolted by the crew. The surface of the sediment is cleaned and flattened. D-tubes, previously cut on one side are pushed into the sediments (two rows at a time, with the first two rows labeled set A and set B and are shifted from one another). Metric tape is stuck continuously along the top of the D-tubes, and each section is labeled with:

- the core number + C (for Casq)
- the section number + a, b or c... depending on the row
- T x cm and B y cm

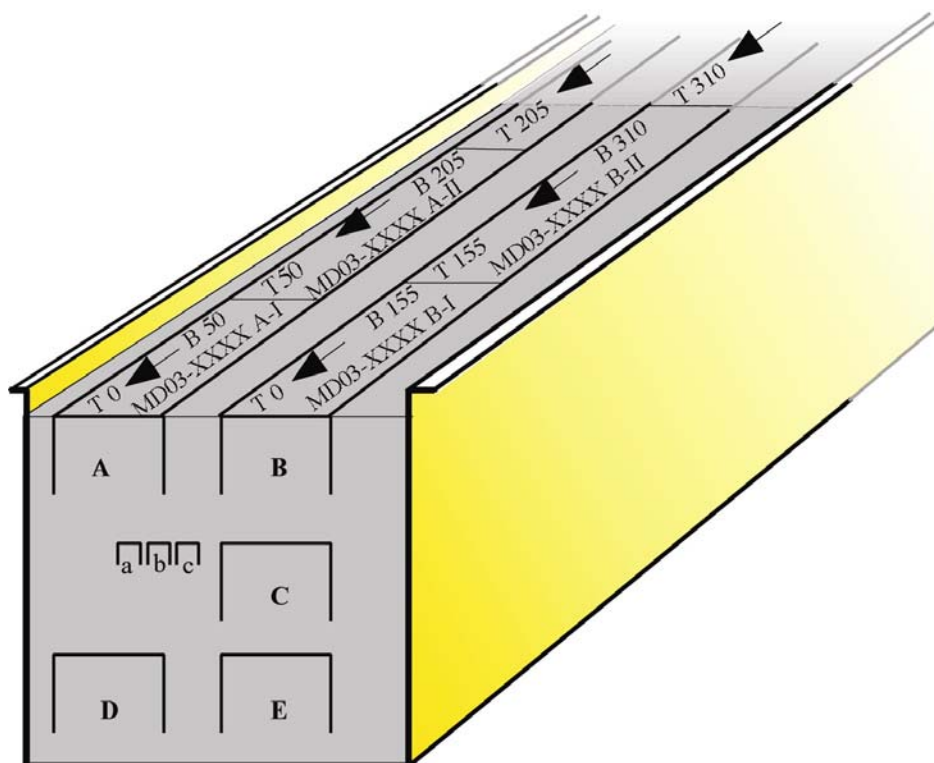

Fig. 8: Sampling scheme of the CASQ cores

After the first two rows of D-tubes are pushed into the sediment, the corer is rotated sideways by the crew. A mark is made every 50 cm on the metallic frame of the corer to keep a record of the length for the next rows of D-tubes. U-channels are taken in the central part of the corer (usually, close to the C row of D-tubes). They are labeled in the same way.

A fishing line is passed under each D-tube and u-channel to cut the sediment, and each D-tube is removed from the corer.

Row A is immediately packed and stored. The u-channels are immediately packed and stored. Row B is then described, photographed and measured with the spectrophotometer and packed. Row C may have some limited shipboard sampling, as determined by the chief scientist. Row C is then packed and stored.

Casq sections are covered with plastic film. The lid is placed on top. The entire D-tube is placed into a long plastic bag and the caps (also labeled) are placed at each side and taped.

Posters made by the paleomagnetic team at LSCE explaining how to handle the cores and how to label them are available on the server "nasoceano" on board the R. V. Marion Dufresne

2.3 Plankton Net Hauls and Seawater Sampling (Geraldine Lemeur)

Living plankton were collected with a **WP2 plankton net**. The mesh size of the net is 200 μm and the diameter of the opening is 57 cm.

Based on temperature profiles of the upper water column (0–100m) using a CTD system, the sampling depth down to 20–50 m was specifically defined for each site according to the top of the thermocline which marks the base of the mixed layer. Fluorometry and CTD sampling data give the plankton sampling depth.

The net was lowered to the defined maximum water depth at a cable speed of 0.5 m/s from the aft deck of the ship remaining there for 20-30 minutes. During the deployment time of the net the ship kept a constant speed of 1.5-2 knots. On board samples were collected respectively between two sieves, sized 850 μm and 150 μm . The fraction over 150 μm was rinsed with sea water and frozen at -20°C.

Foraminifera were used as biomarkers to reconstruct paleoclimatic events.

Eleven **CTD deployments** were obtained during the P.I.C.A.S.S.O. cruise with the SEA BIRD SBE 911 Plus System. The data acquisition rate was 24 scans/s and the cable vertical linear speed was 1 m/s. Temperature, density, depth, salinity, fluorometry, pressure and oxygen were measured every meter through the water column. High fluorometry values gave us an idea of the planktonic layer.

3. Shipboard Data Acquisition and Handling

3.1 Multibeam bathymetry and sub-bottom profiling (Xavier Morin)

An extended documentation of this article (18 pages, many photos and figures) is included on the CD

The multibeam deep-water echosounder Thomson Seafalcon 11, installed on board "Marion-Dufresne" in 1995, is used for cartography and sediment profiling. It runs on two operating modes: the "bathymetry and imaging" mode and the "sub-bottom profiler" mode. Both modes can be run simultaneously, but only at low speeds (less than 4 knots).

Bathymetry and imagery In this operating mode, the echosounder uses transmitted frequencies around a 12 KHz carrier. The range of depths on which this mode can operate is 80 to 11000 metres. Five cross-track swaths are simultaneously created in order to generate a data redundancy (as if five multibeam echosounders were simultaneously used). These swaths are separated by the use of active digital filters. Thus, measurement gaps are avoided. These five swaths are separated (along the boat-track axis) from each other by a 1.4 degree angle. The central swath is vertical. The large antenna 3 dB attenuation level (at transmission) and beam forming at reception allow images to be

built and measure bathymetry at 120 degrees from the track axis of the boat (60 degrees to starboard and 60 degrees to portside). For bathymetry, the resolution across-track depends upon the measured depth H. The length across-track of a resolution cell is typically equal to $H/100$. The number of created soundings for one measurement is typically equal to 2000 (400 per swath).

The imaging system uses the reflectivity extracted from the five separated frequency swaths. A mosaic is created, geographically representing sea bottom level in the studied area. This mosaic is fed by the five sets of backscattered signal. The huge number of data for each swath (18.000) and their redundancy allow a large geographic coverage and the relative increase of the signal-to-noise ratio.

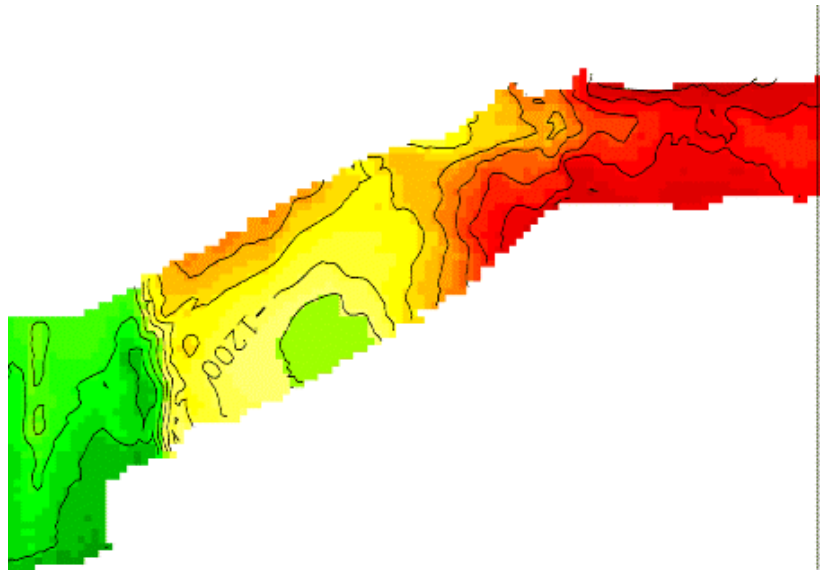

Fig 9: Part of bathymetric map created during an Images cruise (processed with Caraibes software).

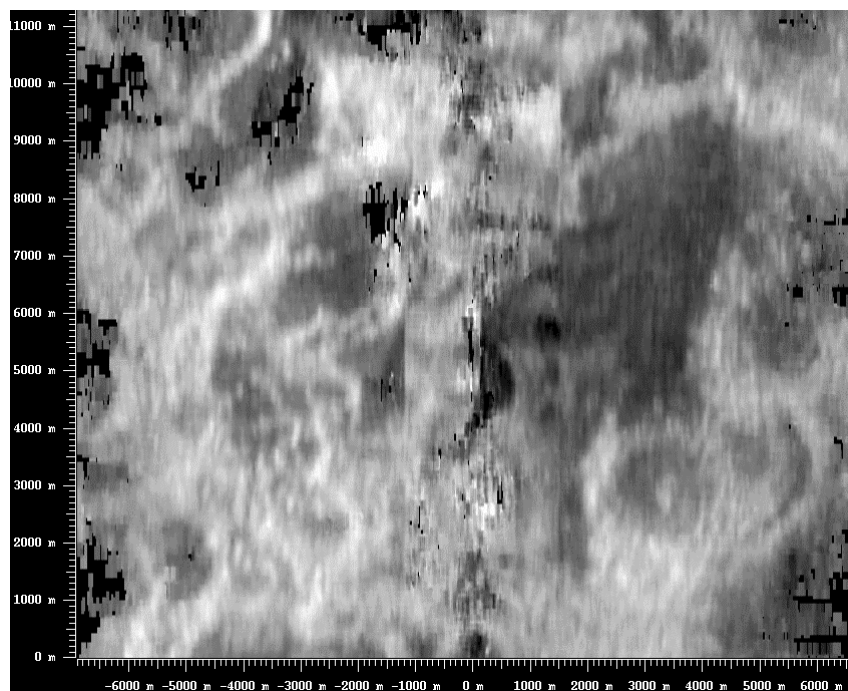

Fig 10: Raw image acquired with Seafalcon 11 echosounder (without post-processing)

Sub-bottom profiler The Seafalcon 11 echosounder also includes a sub-bottom profiler. This system is able to create reflectivity slices of the sub-bottom sea floor as a function of the geographical position of the boat. The central frequency used for this system is equal to 3.75 KHz. As for the “bathymetry and imaging” mode, the transmitted wave is linearly frequency modulated. The corresponding correlation gain is equal to 23 dB. The large transmitted bandwidth (1.6 KHz) achieves a small spatial resolution (0.31 metres).

As described above, beam forming from many signals received on each sensor provides a very narrow antenna diagram (high directivity), during emission (4.8 degrees) and reception (5.8 degrees). This beam formation also achieves a high acoustic signal level.

Five beams are created on reception (the central beam is vertical), separated from each other by 5 degrees. This diversity provides an opportunity to record good quality profiles when the across-track slope is steep. Typically, 100 metres penetrations are achieved for a 4000 metres depth.

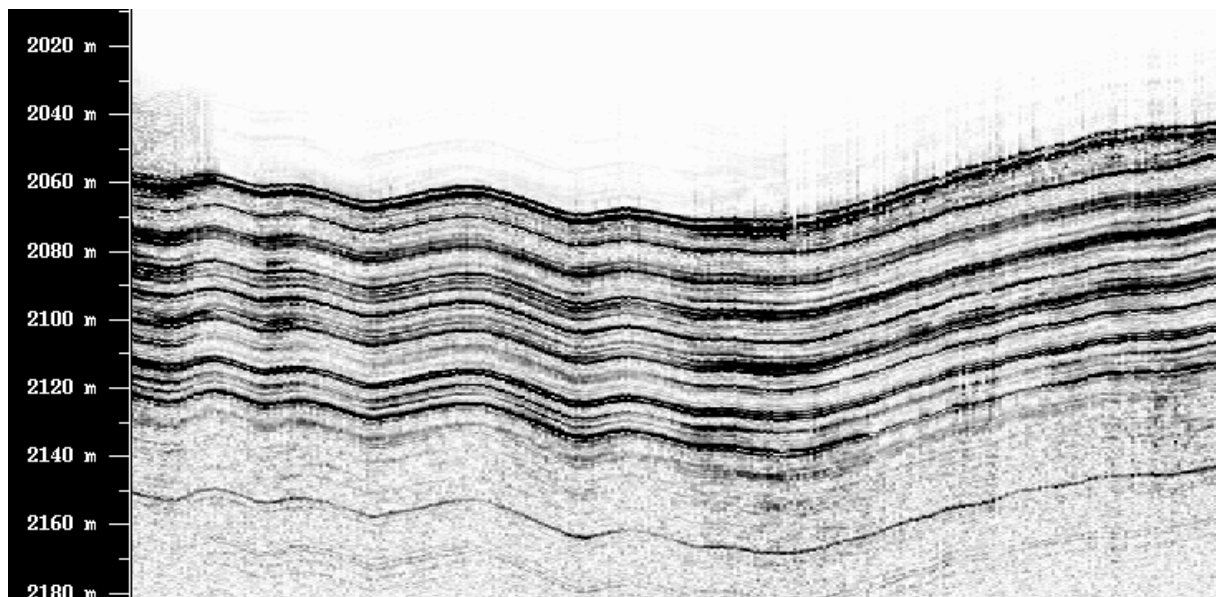

Fig 11: Sub-bottom profiling chart created during the Images 7 cruise.

Post-processing The post-processing of bathymetry and imaging data is carried out with the “Caraibes” software, developed by I.F.R.E.M.E.R. This program enables:

- The creation of geographical digital data grids for bathymetry. Contour extraction, “spline” curves filtering and bi-dimensional digital filtering are examples of tools that can be used to remove any possible artefact. Three-D representations are possible.
- The creation of reflectivity mosaics for images. Filtering and contrast enhancement can then be applied. A version for real time display is also installed aboard “Marion Dufresne”.
- To view sub-bottom profiles, the IF RTP has also developed a Unix-based software that uses gmt and is freely available to interested scientific teams.

During this cruise, the IF RTP-Software “Rejeu” was used to replay the seismic profiles and to create images in Postscript- format from them. These were then converted to JPEG format, clipped into documents with additional information and finally stored in PDF-format.

3.2 Station and Area Maps (Stefan Rothe)

For each station maps were created with GMT (the Generic Mapping Tools). The coastline was created with the "pscoast" command. Bathymetry was added on the basis of the ETOPO2 dataset, which provides 2'-gridded elevation data. The ship's track data was included, using the automatic GPS-logfile data from the ship's automatic logging devices. Core positions and labels were then plotted. All maps were produced in Postscript format, and converted to PDF format.

3.3 MST (Alain Mazaud)

3.3.1 Introduction

The Geotek Multi-Sensor-Core-Logger installed on board the Marion Dufresne in the "MST" container is dedicated to the first measurements of physical properties of sediment cores. Measured properties are:

P-Wave travel time, core diameter, and temperature:

A transducer generates ultrasonic compressional waves (P) and sends them across the sediment. Another transducer receives the P-waves, which propagate across the sediment and core liner. The MST computer measures the travel time. The transducers are oil filled Acoustic Rolling Contact transducers. The active element is a piezo-electric crystal. The P-Wave system is mounted vertically when the MST is configured for split cores. It features a moving vertical slide onto which the upper P-Wave transducer is mounted. When split sections are measured, the upper transducer is moved up when sediment translates, and down for measurements.

A short P-wave pulse is produced at the transmitter. It propagates through the core and is detected by the receiver. Travel time of the pulse is measured with an accuracy of 50 ns. P-wave velocity can be calculated with a precision of about 1.5 m/s.

For horizontally split cores, the upper transducer is lowered onto the split surface at each measurement step. To avoid any contamination by sediment, it is recommended to cover the split surface with a thin plastic film. A few drops of water spread along the surface of this film may improve the acoustic contact between transducer and sediment. Spreading some water over the core and the receiver may help the acoustic contact.

A separate sensor measures changes in core diameter. This enables compression wave velocity and density to be corrected for changes in core diameter.

The temperature of the sediment is also recorded, because temperature affects the calculation of P-wave velocity. Measurement of the sediment thickness is also routinely performed. Core thickness is the effective distance between the active faces of the two P-Wave transducers. In practice, deviation from a reference thickness is recorded. For halve cores reference thickness is 5 cm.

Gamma ray attenuation:

The gamma-ray system is mounted vertically when the MST is configured for split cores. A narrow beam of gamma rays (5 mm diameter) is emitted from a Cs-137 source with energy around 0.662 Mev. The photons pass through the core and are detected on the other side. The small Cs capsule is securely housed inside a 150 mm diameter lead filled cylinder.

The gamma ray detector consists of a scintillator and a photo-multiplier tube. Impulses from the detector unit are sent to a counter board in the main electronics rack.

The low field susceptibility:

Magnetic susceptibility is sensitive to diamagnetism, a natural property of any matter (in general negligible), paramagnetism which is associated to the presence of magnetic spins at the atomic and/or molecular scale (clays), and ferro/ferri/antiferro magnetism, in which a magnetic ordering exists over long distance at the atomic scale (over thousand or atoms and more in crystalline matter). Metallic oxides may exhibit ferro/ferri/antiferro magnetism.

A low field susceptibility sensor (Bartington) determines the amount of magnetically susceptible material present in the sediment. A loop sensor is installed when entire sections are measured, while a point sensor is mounted vertically when half sections are measured. An oscillator circuit in the sensor produces a low intensity alternating magnetic field. The presence of magnetic material near the sensor changes the inductance of a small coil, which is detected by the electronics (change in the resonance frequency of an electric circuit which includes the coil).

Susceptibility measurements were done every 2 cm for all the cores. ASCII files with the raw data and the processed data were created for each core. Figures were then made from the processed data files by using Excel software.

The Multi-Sensor-Core-Logger is mounted horizontally on floor. It can be configured either for entire sections or for halves sections, obtained after longitudinal splitting of the core sections. Core sections (with plastic end caps sometimes for liquid sediments) are 150 cm long and about 50 mm height (half cylinder obtained after splitting).

During the PICASSO cruise, we adopted the half core configuration. Working halves were passed through the MST.

3.3.2 Calculated parameters and calibration

The GEOTEK software calculates the final physical parameters from the raw measurements.

Final parameters are:

- P-Wave velocity
- Gamma density
- Porosity
- Impedance
- Low field susceptibility
- Temperature

These calculations require some calibration.

Gamma density and porosity

The basic equation for calculating bulk density is $\rho = (1/\mu \cdot d) \cdot \ln(I_0/I)$ where

ρ = sediment bulk density

d = sediment thickness

μ = Compton attenuation coefficient

I_0 = the gamma source intensity

I = the measured intensity through the sample.

Attenuation through the liner and the water has to be considered to obtain the bulk density of the sediment. Calibration consists of counting the gamma rays passing through a known thickness of water (for instance close to the mean sediment thickness) and through water + pieces of aluminium of different thickness. The total thickness Al. + water must remain constant.

A plot of $\ln(\text{count})$ versus average density (which of course depends on the thickness of Al) is then made and fit with a 2nd order (parabolic) polynomial. The polynomial coefficients give A, B and C, which have to be entered in the GEOTEK program when processing the data. Note that the curve is not exactly a straight line because of secondary effects (beam dispersion, etc.).

For example, we have obtained (11/06/03)

A= -0,0036

B= - 0,0008

C= 9,8451

We recommend to use a count time of 10 s when doing gamma attenuation calibration

Porosity can be calculated from sediment density assuming:

- the sediment is fully saturated
- the mineral grain density is known (MGD = 2.75)
- the fluid density is known (WD = 1.026)

Then, the fractional porosity is obtained by $FP = (MGD - \rho) / (MGD - WD)$

P-wave velocity and acoustic impedance

The P-wave velocity of the pulse through the sediments inside the core liner is given by:

$V = H / TT$ where H is the sediment thickness and TT is the pulse travel time in the sediment.

The measured total travel time in the sediment is $TOT = TT + PTO$, where PTO is the P-wave Travel time Offset, which represents all the additional time delays. PTO includes the pulse travel time through the line and the transducers faces, small electronic delays, etc.

Calibration consists of determining the PTO:

Distilled water is put in an empty liner, which is then placed between the transducers. The upper transducer should be just in contact with the water surface.

Measured parameters are

- Total Thickness D (cm)
- Total Liner Thickness W (cm)
- T = water temperature

Sound velocity in distilled water (V) at Temperature T is obtained from a table.

From TOT, PTO is calculated by $PTO = TOT - (D - W) / V$
(typical value: 16.56 μ s, obtained on June 11, 03)

PTO is then entered in the GEOTEK program when processing data.

The acoustic impedance is calculated as the product of the P-wave velocity and density.

Core Thickness:

To calibrate the DT, we select two calibration cylinders of know diameter (with a difference of about 20 mm). We placed the smaller one between the transducers and adjust the zero. Then the larger piece is inserted and the span is adjusted to obtain the difference of diameter.

We did not do this calibration.

Magnetic Susceptibility:

The Bartington point sensor is automatically lowered onto the core surface at each measurement. This sensor can only be used at a sampling rate of 1.0 Hz (1 s period). The unit of measurement is 10⁻⁵ SI.

Be careful to not bring any metallic material in the vicinity of the sensor (screwdriver, wristwatch, jewelry, etc.), which may alter measurements. It may be sensitive to temperature fluctuations.

If necessary, zero the susceptibility meter before measuring a new core.

Manufacturer of the MST equipment:

GEOTEK

Nene House, Drayton Fields

Daventry, Northants

NN11 5EA. United Kingdom

Tel: 44 1327 311666

Fax: 44 1327 311555

E-mail: info@geotek.co.uk

Web: <http://www.geotek.co.uk/>

3.4 Physical properties, sampling (Patricia Manley)

Over 1376 discrete samples have been obtained from most casq cores and selected Calypso cores for MD03. These samples were taken at a 10-cm interval (5-cm interval spacing for MD03-2674), using the syringe method to obtain accurate wet volume. Saturated bulk densities and other physical properties such as porosity, water content, and void ratio will be derived from the wet and dry (24 hours at 100°C) discrete sample weights. These data will be used for geophysical analyses (e.g. synthetic seismograms) as well as bulk density measurements that are needed to calculate sediment fluxes. In addition, comparison between calculated densities and water content in conjunction with MST data will be used to investigate the amount of stretching associated with Calypso coring.

3.5 Colour reflectance using Minolta Spectrometer (Min-Te Chen, Andrew Hatch)

We used the same procedure used in previous cruises of the Marion Dufresne, as explained in the MD126 / MONA cruise report, which we reproduce here.

Diffuse spectral reflectance measurements on sediment surfaces provide a rapid, high-resolution and non-invasive tool for estimating sediment compositions such as carbonate, organic carbon, and opal concentrations, which are essential information for high-resolution paleoceanographic research. The Minolta spectrophotometer 2002 used during the PICASSO cruise is a compact, handheld, sea-going instrument for measuring spectral reflectance. This device measures spectral data 1) by flashing light from an internal, pulsed, xenon arc lamp through a circular aperture (diameter of aperture = 11 mm, measurement area diameter = 8 mm) at the base of the instrument off the surface of the specimen, and 2) by recording the levels of light reflected back through the aperture to its sensor at various wavelengths within the visible range of the electromagnetic spectrum (400-700nm).

During the cruise, measurements were taken from the sediment surface of split working halve core sections either at 5cm intervals, or for the purpose of analyzing high-resolution records, at 2cm intervals. Before measuring reflectance data for sediment cores, the spectrophotometer was first calibrated against open space for a minimum reflectance reading and then against a white standard

(Spectralon) for a maximum reflectance reading. Specimen measurements result in 16 channels of averaged percentage reflectance values for every 20-nm wavelength interval. These reflectance data can be interpreted as compositional changes of sediment through calibration against ground truth core measurements of sediment compositions.

The spectrophotometer also automatically calculates five parameters: L* (lightness), a* (red/green attributes), b* (yellow/blue attributes), C* (chroma/saturation), and h (Hue-angle). The output Excel files of the color reflectance data measured in this cruise contain data of measurement depths, values for these five parameters and 16 channels of 20-nm wavelength percentage reflectance data.

3.6 Photography

Photography of 0.5 m segments of the core sections was done with a digital AGFA system. 3 Photos were taken from each core section. All individual photos were combined to one "section photo" and these were compiled to sheets, covering 15 sections of a core. The combined section photos remained their original resolution, the resolution for the compiled sheets was reduced in order to optimize filesize.

3.7 Sedimentology (Mary Jane Coombs, Ingrid Hendy)

We used the same procedure used in previous cruises of the Marion Dufresne, as explained in the MD126 / MONA cruise report, which we reproduce here.

Lithology, sedimentary structures, texture and coring disturbances were described for each core section. All original sedimentology descriptions were scanned after cruise and are available as PDF-files on CD or at www.images-pages.org/ftp/pub/.

A generalised stratigraphic description for each core based on the individual core-section descriptions was then compiled, using Adobe Illustrator 8.0. Lithological symbols were created as Adobe Illustrator "swatches," and structure and drilling-disturbance symbols were primarily created as Adobe Illustrator "brushes." These sets of brushes and swatches are available at www.images-pages.org/ftp/pub/. To use these symbols, open the file legend.ai and copy and paste the swatches and brushes into your own files; this will add these features to your own swatches and brushes palettes within Adobe Illustrator.

Legend for Core Description

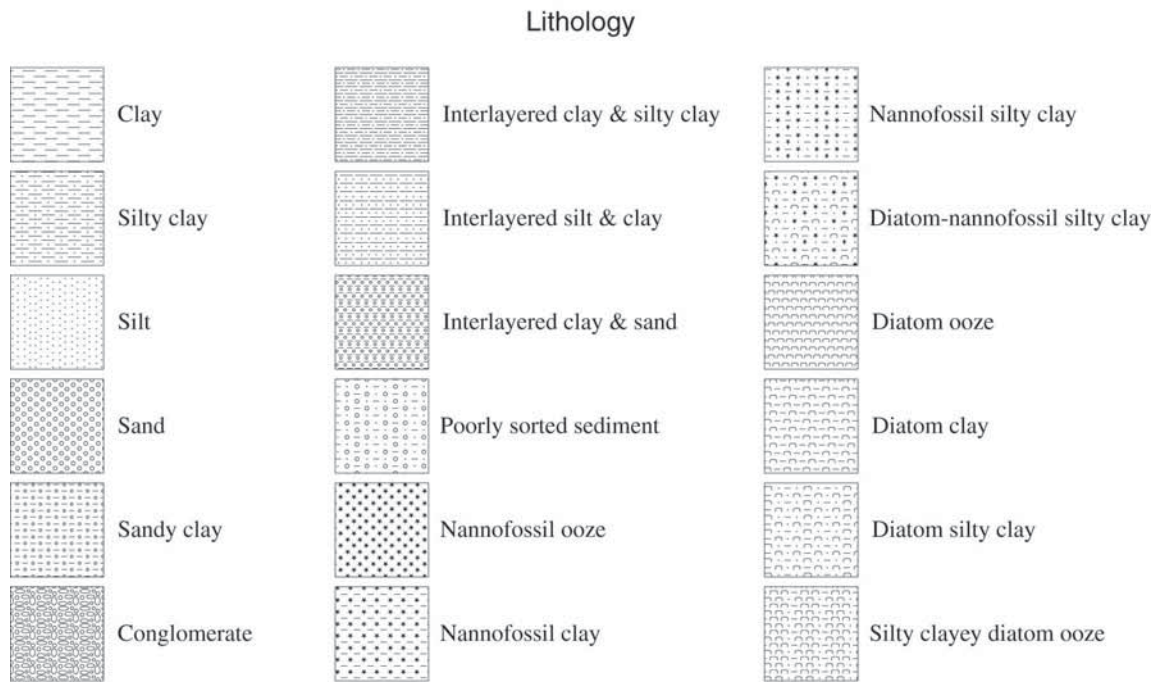

Structure and Drilling Disturbance

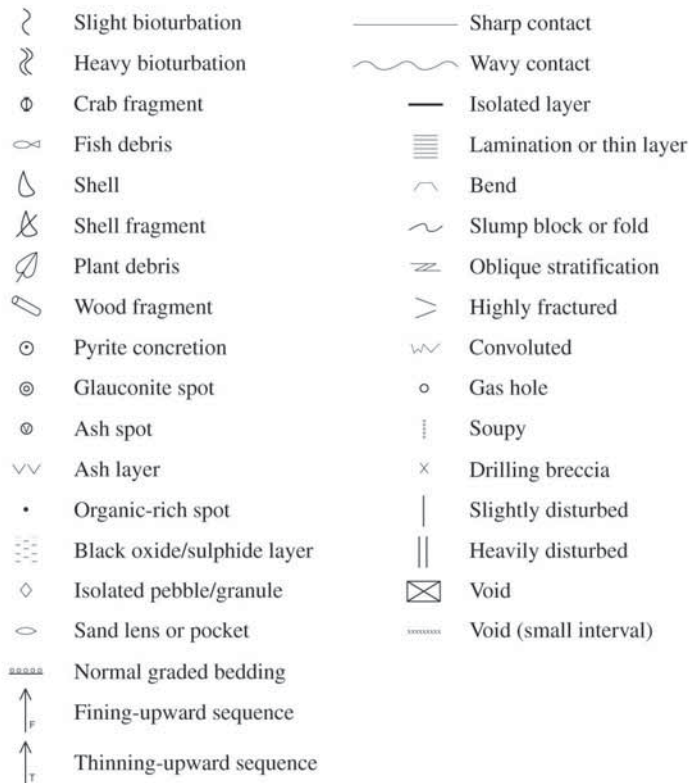

Fig. 12: Legend for core description files in this report.

3.8 Data Management and Long–Time Archive (Stefan Rothe)

All shipboard data was obtained, analyzed and plotted on board. Documentation for each core consists of a station map, a subbottom profile, the sedimentology description and core photography, as well as plots of the MST data and color-reflectivity data. The complete documentation in PDF-format is included in the report on CD. It is also available at the IMAGES website:

www.images-pages.org

As an example, the documentation of one complete site is included below, with added comments.

For some cores individual files are missing, due to missing data.

All shipboard data will also be archived as numeric data at the world data center **WDC Mare, Bremen**. The data can be retrieved from www.wdc-mare.org, www.pangaea.de with PangaVista, or www.images-pages.org (database section) from a core list.

All shipboard data will be exclusively available to the scientific shipboard party for the next two years. From July, 2005 the shipboard data will be open to the scientific community. Contact the principal investigator of a core to obtain collaboration within the 2-year moratorium period or to get access to the data.

4. Correlation of Cores from Site 58

Station 58 is located south of Iceland, in the Gardar-Drift area. At this station, 3 different coring mechanisms were used: First, a gravity core has been taken, being followed by a Calypso Square Core (CASQ) and a Calypso Giant Piston Core. The three cores have been correlated on the basis of their colour reflectance curves, showing the influence of the coring mechanism used on the sediment retrieved. The result is given below.

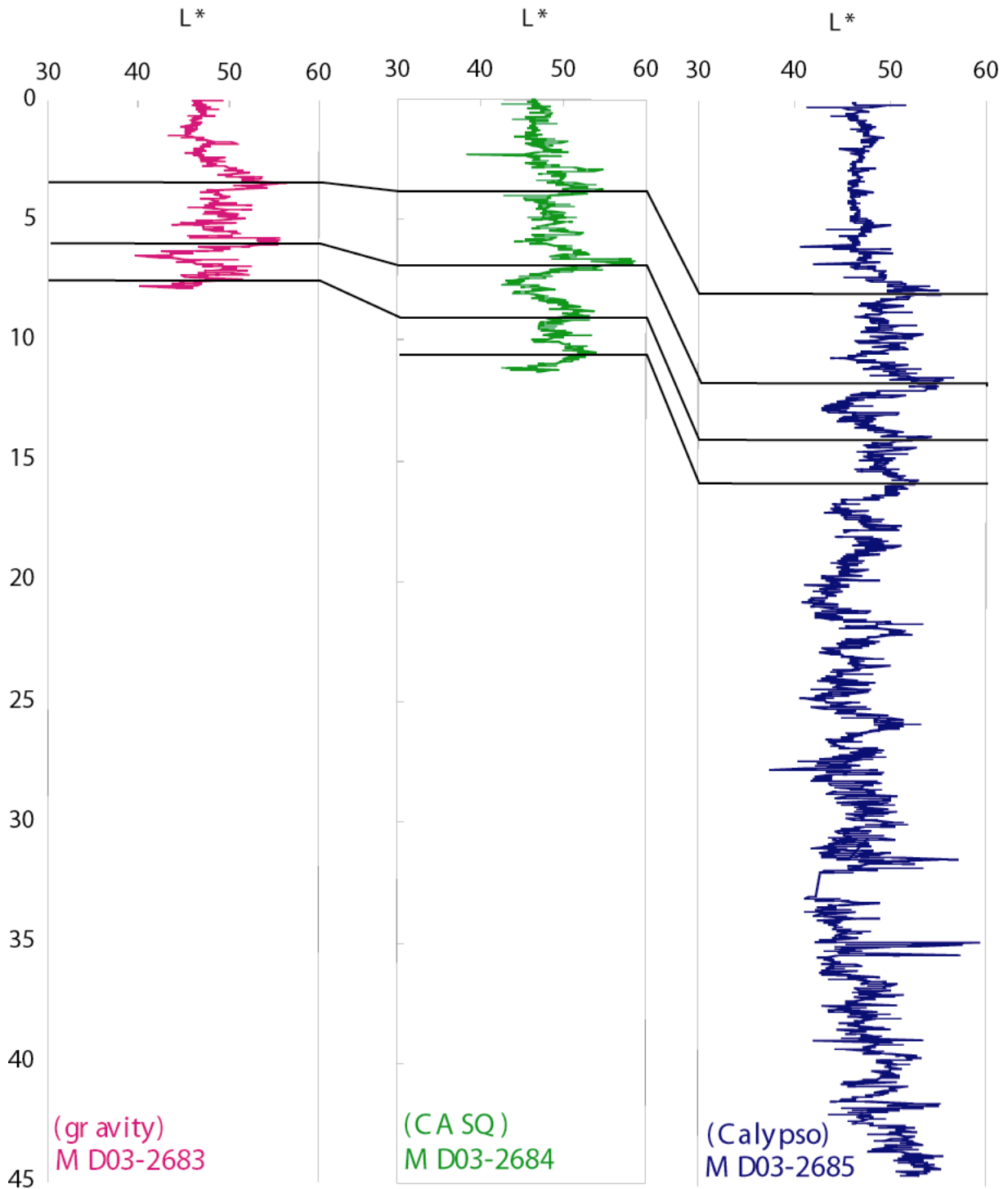

Fig. 13: Correlation of the three cores taken at Station 58 using the reflectance parameter measured on board. Three different corers have been used at this station: the gravity corer for core MD03-2683, the CASQ for core MD03-2684 and the Calypso for core MD03-2685. The main correlation lines are reported.

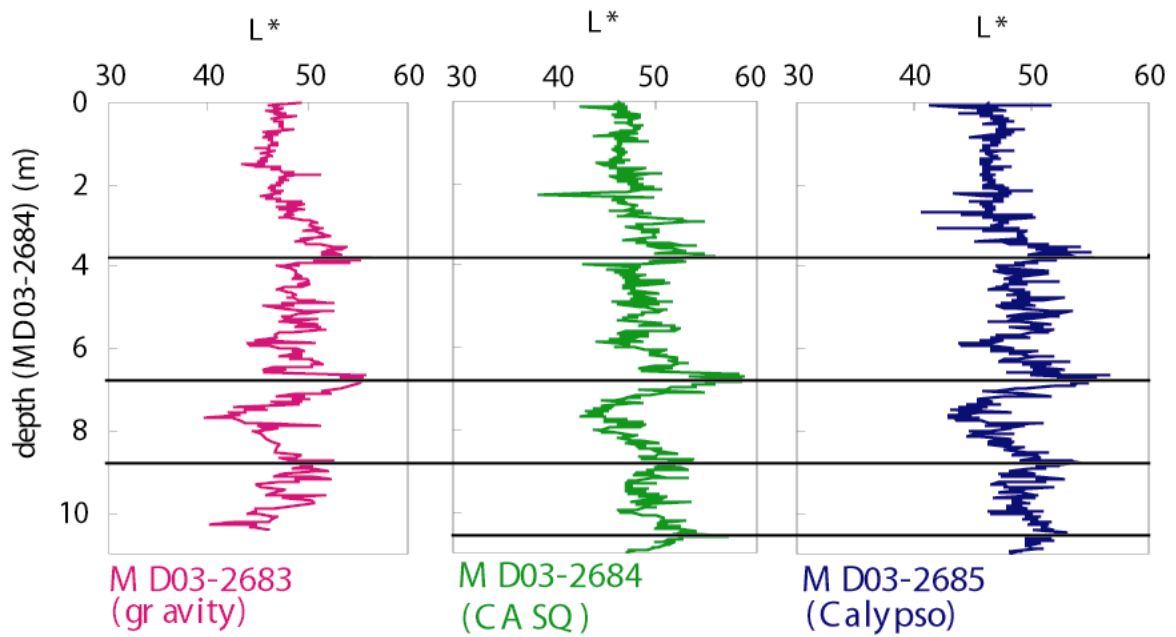

Fig. 14: The reflectance signal after correlation versus depth of core MD03-2684 (CASQ)

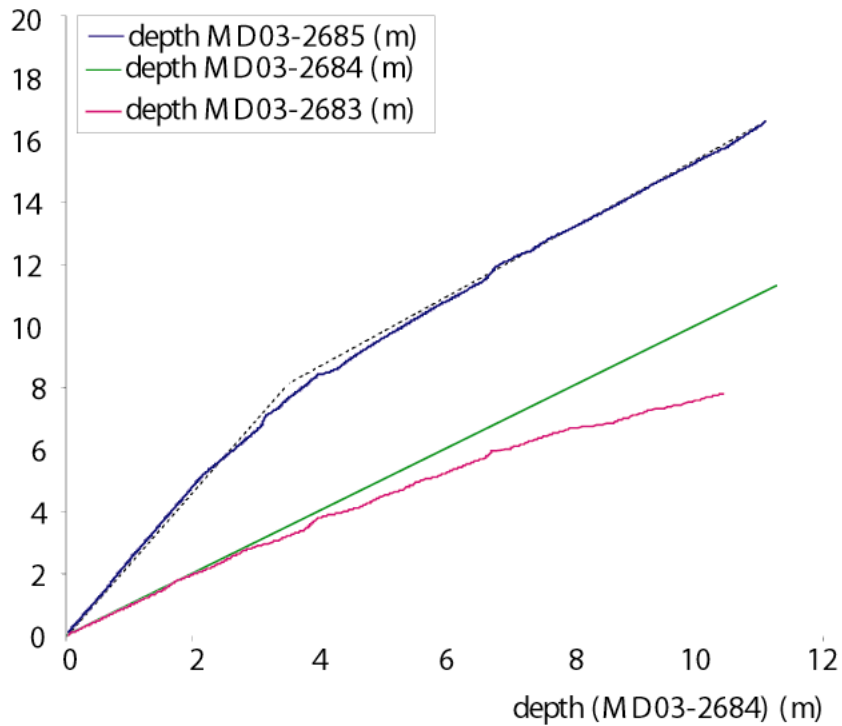
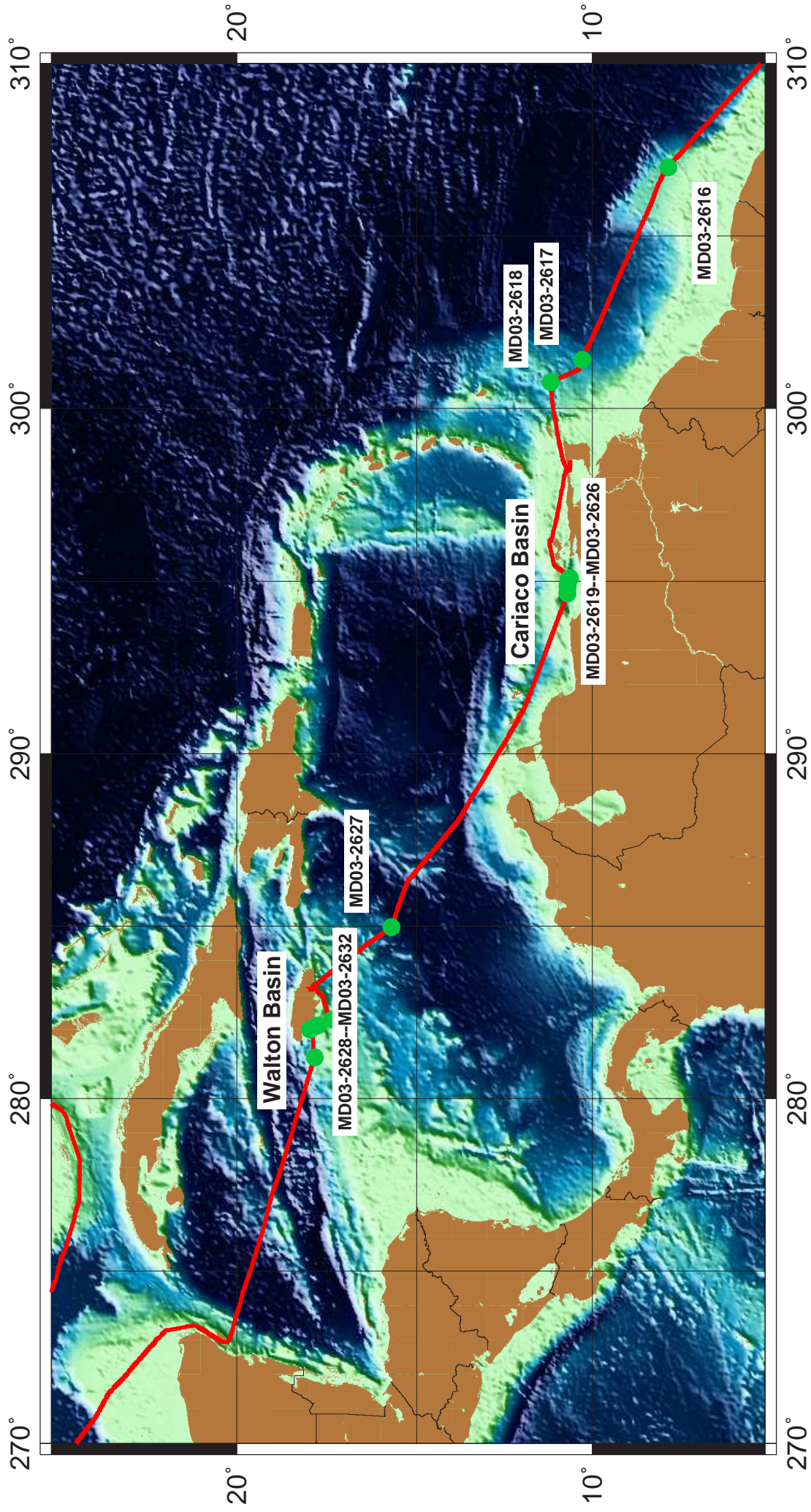
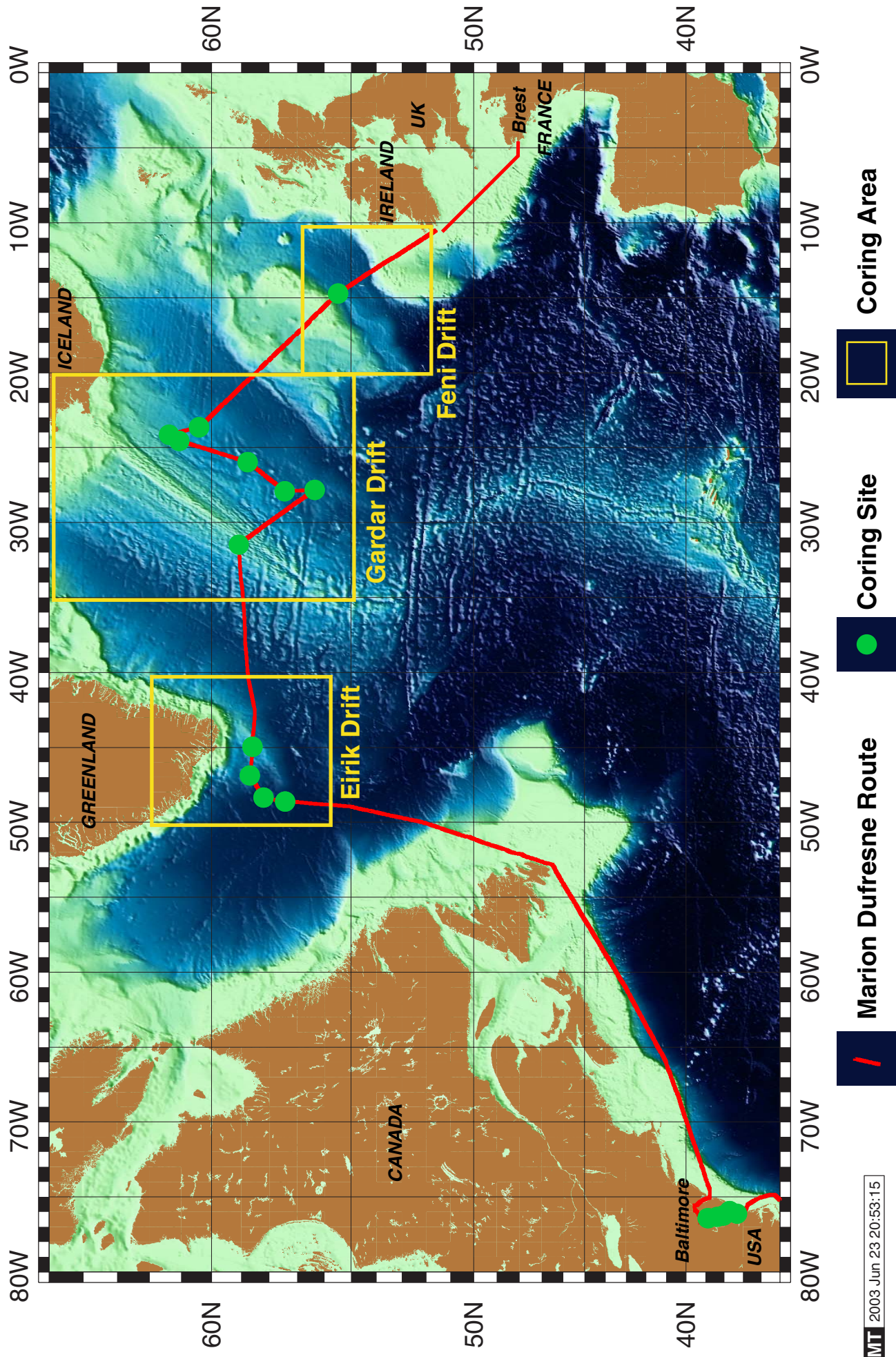

Fig. 15: Relationship between the different depths of the three cores (all are reported versus depth of core MD03-2684, the CASQ). Obviously, the gravity core is compacted with respect to the CASQ and the Calypso is extended. The extension in the Calypso is in two phases, illustrated by the two dashed lines: The top 7m are equivalent to the first 3.2 m in the CASQ with an average extension factor of 2.3. Below, the “extension factor” is about 1.15.

PICASSO Leg 1



PICASSO-Leg 2



6. Site Report and Core Documentation of Site 58 as Example

The complete documentation of all sites and cores consists of several hundred pages and is given in PDF format on the included CD. Find the CD attached to the inner front cover. To access the documents you need the free software Acrobat Reader from ADOBE, available for download at

<http://www.adobe.com/>

To get the pages you are interested in, open the PDF-file on the CD with Acrobat Reader and make sure that the “bookmarks” are shown at the left side of the screen. Now you can easily navigate within the hierarchical tree, provided by the bookmarks. With a doubleclick on a bookmark you directly jump to the appropriate page of the document.

Station 58 was chosen as example for the site report and core documentation like it has been produced for every station and core of this cruise.

Gardar-Drift

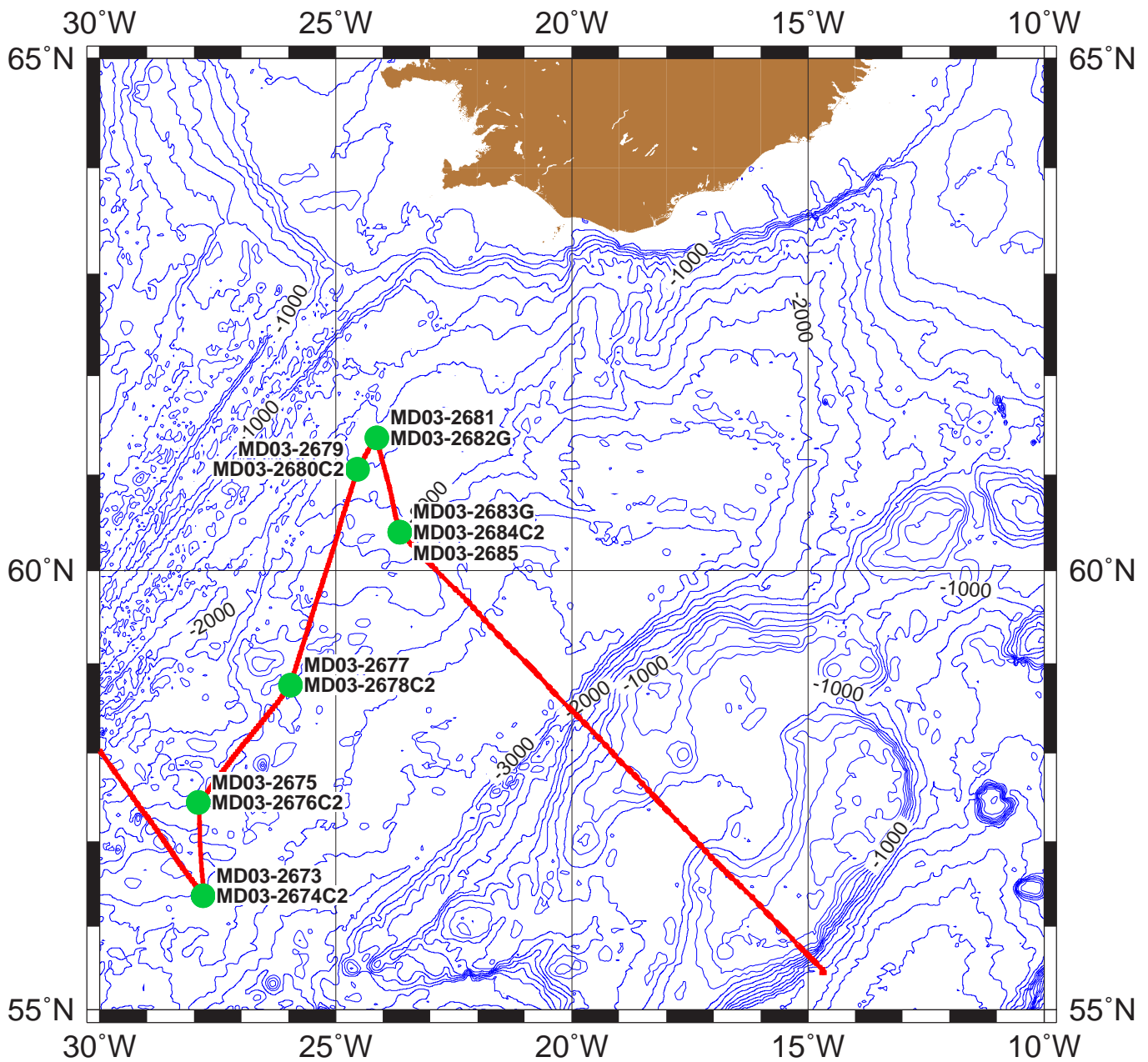

MD03-2683

20.06.2003, 08h54 UTC

Core length: 7,87 m

Lat: 60°24.08' N

Lon:

23°38.39 W'



Water depth : 1979 m

CORE SITE MD03-2683

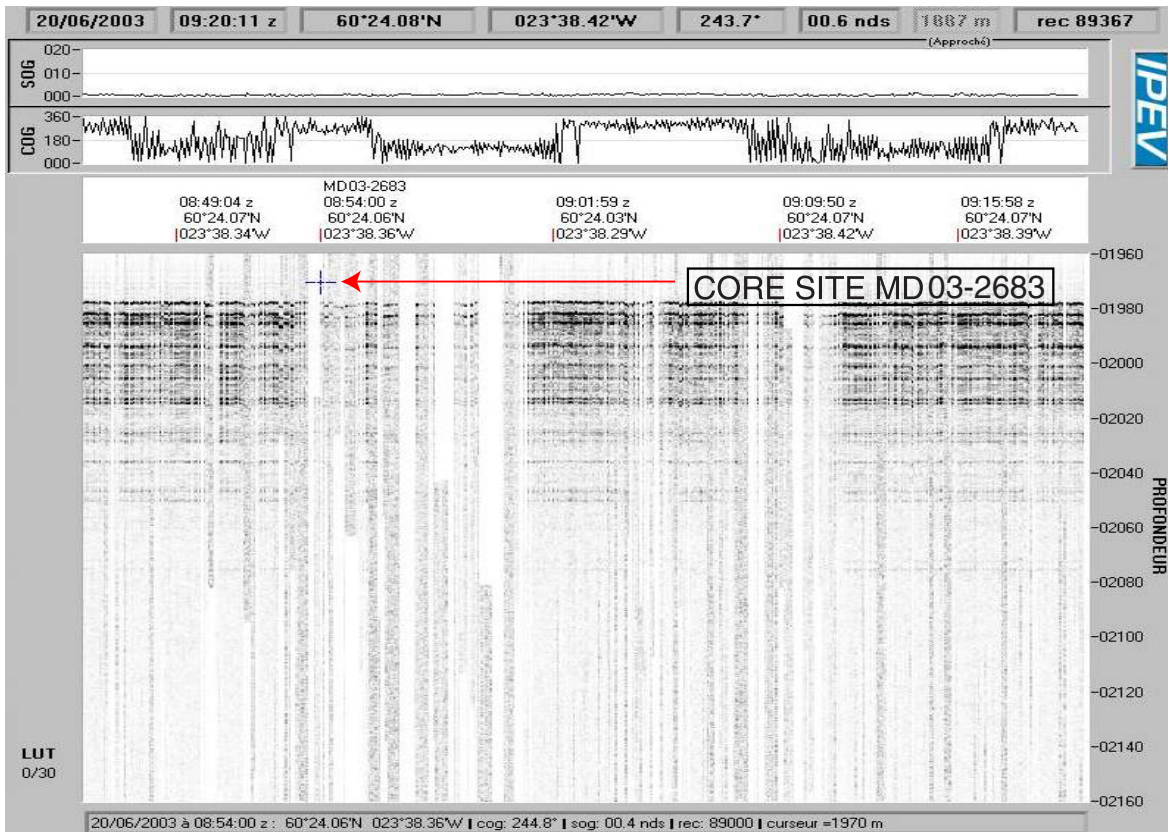
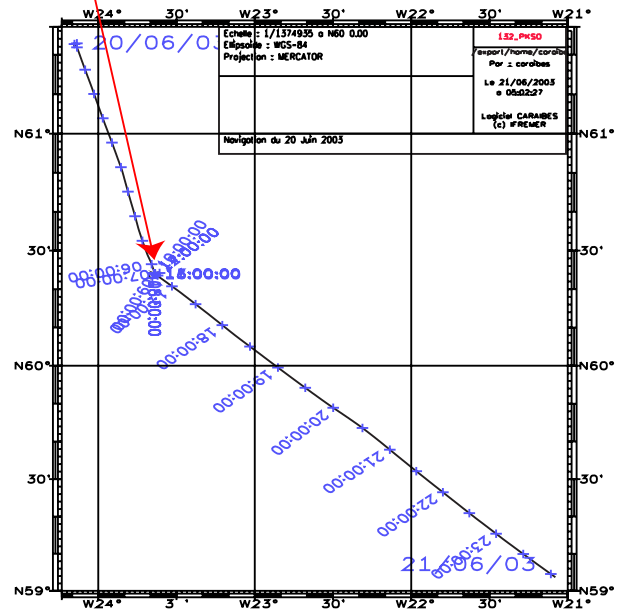
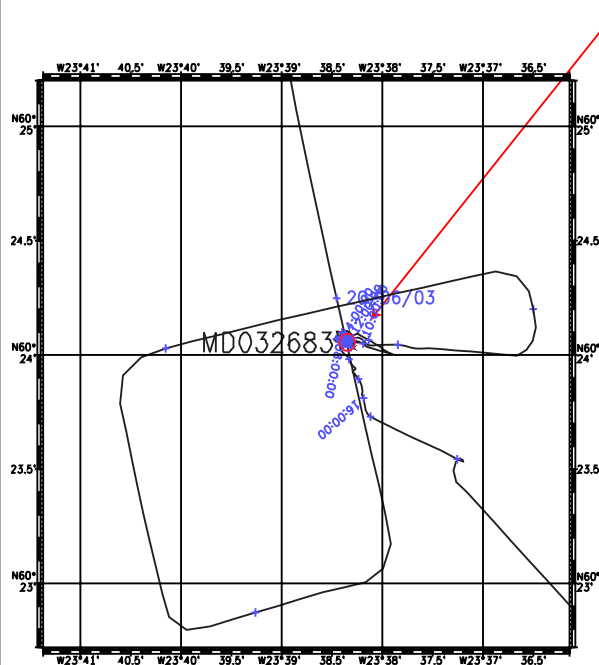

NOM DE LA CAMPAGNE
MD 132/P.I.C.A.S.S.O.

DATE 20.06.2003
N° de station : 58

Météo : (force) / Direction
Vent : **18 nœuds**
Mer : **Peu agitée**
Variation tension (maxi) :

CAROTTE (N°) :
MD 03-2683
(MD - année - milles - centaines)

CAROTTE (longueur) :
7.87 m

POSITION :
Latitude : **60°24.07 N**
Longitude : **023°38.34 W**

CAROTTIER (type) ⁽¹⁾ : **GRAVITE**

Poids total (air) : **t**

Poids total (eau) : **t**

REGLAGES :

Tubes (longueur) : **14.80 m**

Câbles :
Chute libre : **m**

Boucle : **m**

LC poids : **m**

CONTREPOIDS :
Type (2) :

Longueur PVC : **m**

Pénétration : **m**

Longueur de carotte + Ogive (+ 0,15 m) **m**

PARAMETRES MESURES :

Sonde corrigée : **1 979.00 m**

Ligne filée : **1 985.00 m**

Arrachement/total (tonne) : **t**

Arrachement/différentiel (tonne) : **t**

Pénétration/apparente (m) : **m**

Pénétration/tensiomètre (m) : **m**

HEURES (GMT)

En station : **8:12**

Début manœuvre : **8:13**

Touchdown : **8:54**

Fin de manœuvre : **09:36**

Durée de manœuvre : **01:23**

Départ station : **Resté en station**

INSTRUMENTATION OPERATIONS ANNEXES

Pinger :

Flux de chaleur :

CTD (hydro) :

CTD (bouteilles) :

Filet à plancton :

Autres :

Description / incidents :

0	150	300	450	600	750	900
I	II	III	IV	V	VI	
					782-FINI	

(1) CALYPSO - CALYPSO GRAVI/FLUX - BOX CORER 1/4m ou carré géant

(2) Cylindrique 100 kg / Plat / Préleveur

MD03-2683 (sections I to VI)

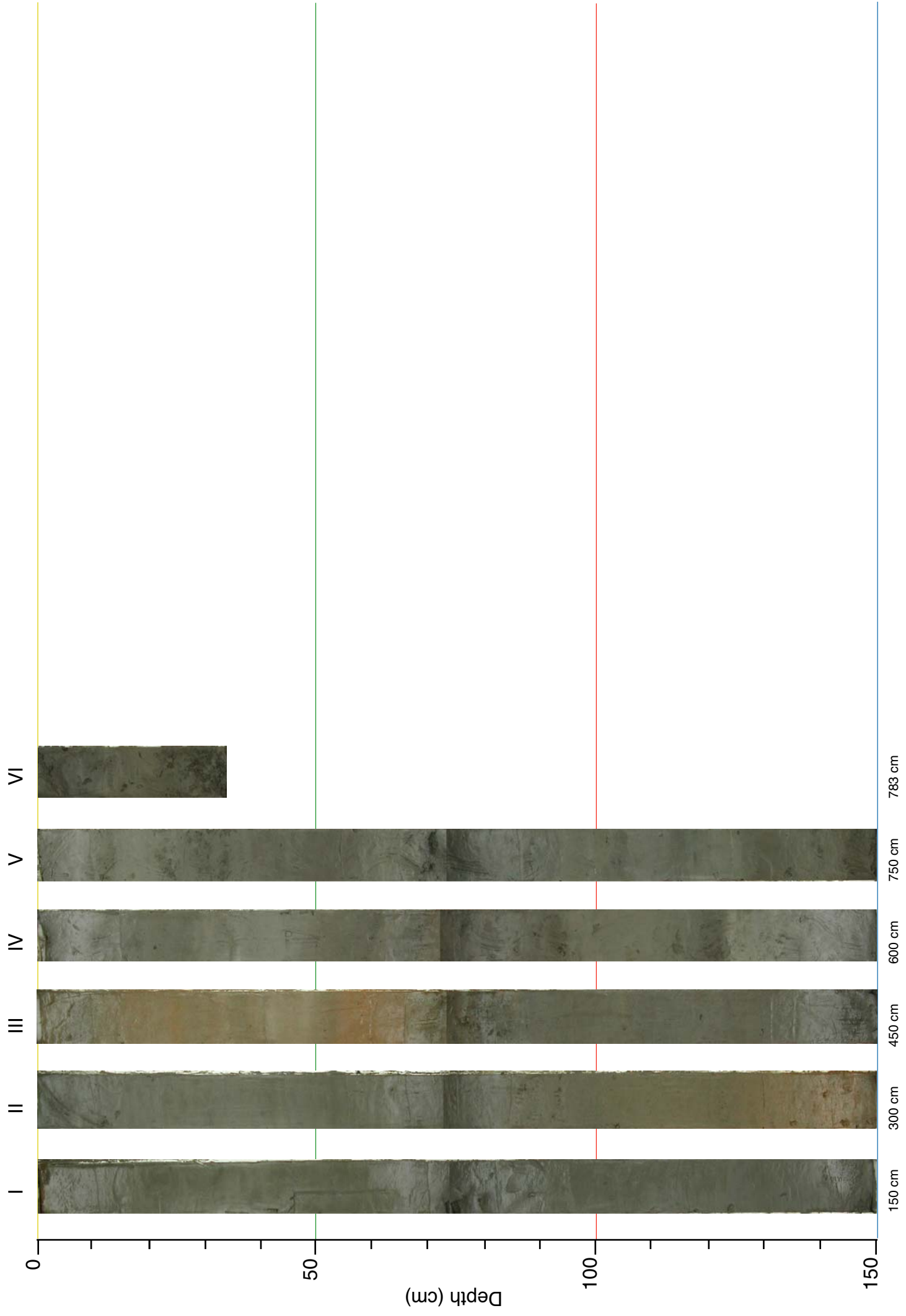

**IMAGES XI, 2003
PICASSO**

Sediment Description

**Station 58
Core MD03-2683G**

Depth (m)	Core section	Lithology	Structure	Samples	Drilling Disturbance	Comments
0						light greenish gray slightly silty clay
1	I		~ ~ ~ ~ ~ ~			
2						gray slightly silty clay
3	II					light grayish brown to pale brown (slightly) silty clay
4						slightly silty clay, various shades of brown
5	III					gray slightly silty clay
6						slightly silty clay, various colors (gray, light gray, shades of grayish brown/ brownish gray)
7	IV		~ ~			grayish white slightly silty clay light gray slightly silty clay (very) light gray slightly silty clay gray slightly silty clay
8	V					light gray clay gray to light olive gray clay light brownish gray and gray (slightly) silty clay
9						
10	VI					
11						
12	VII					
13						
14	VIII					
15						

Depth (m)	Core section	Lithology	Structure	Samples	Drilling Disturbance	Comments
15						
16	XI					
17						
18	XII					
19						
20	XIII					
21						
22	XIV					
23						
24	XV					
25						
26	XVI					
27						
28	XVII					
29						
30	XVIII					
	XIX					
	XX					

**IMAGES XI, 2003
PICASSO**

Multi Sensor Core Logger

**Station 58
Core MD03-2683G**

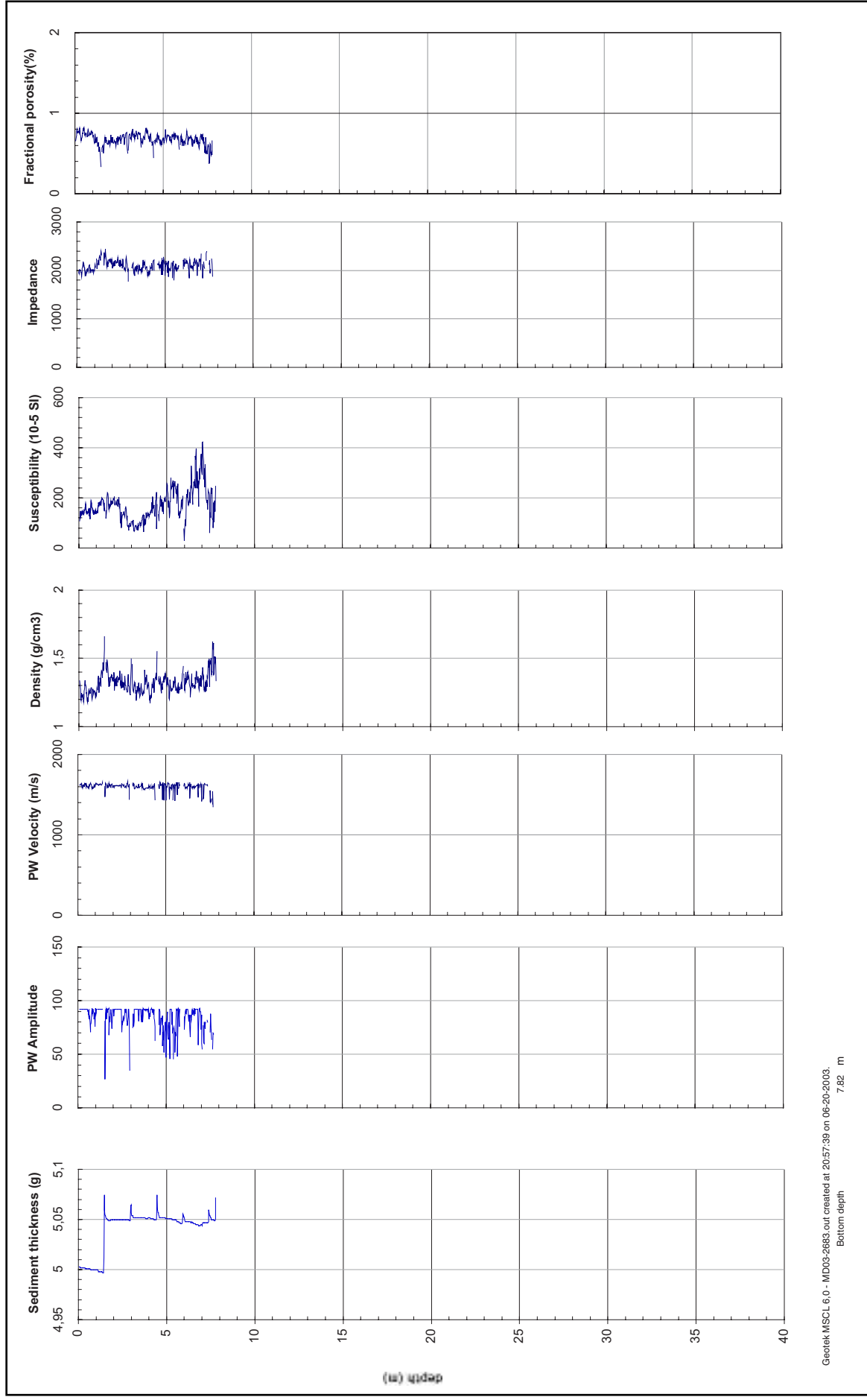

**IMAGES XI, 2003
PICASSO**

Colour Reflectance

**Station 58
Core MD03-2683G**

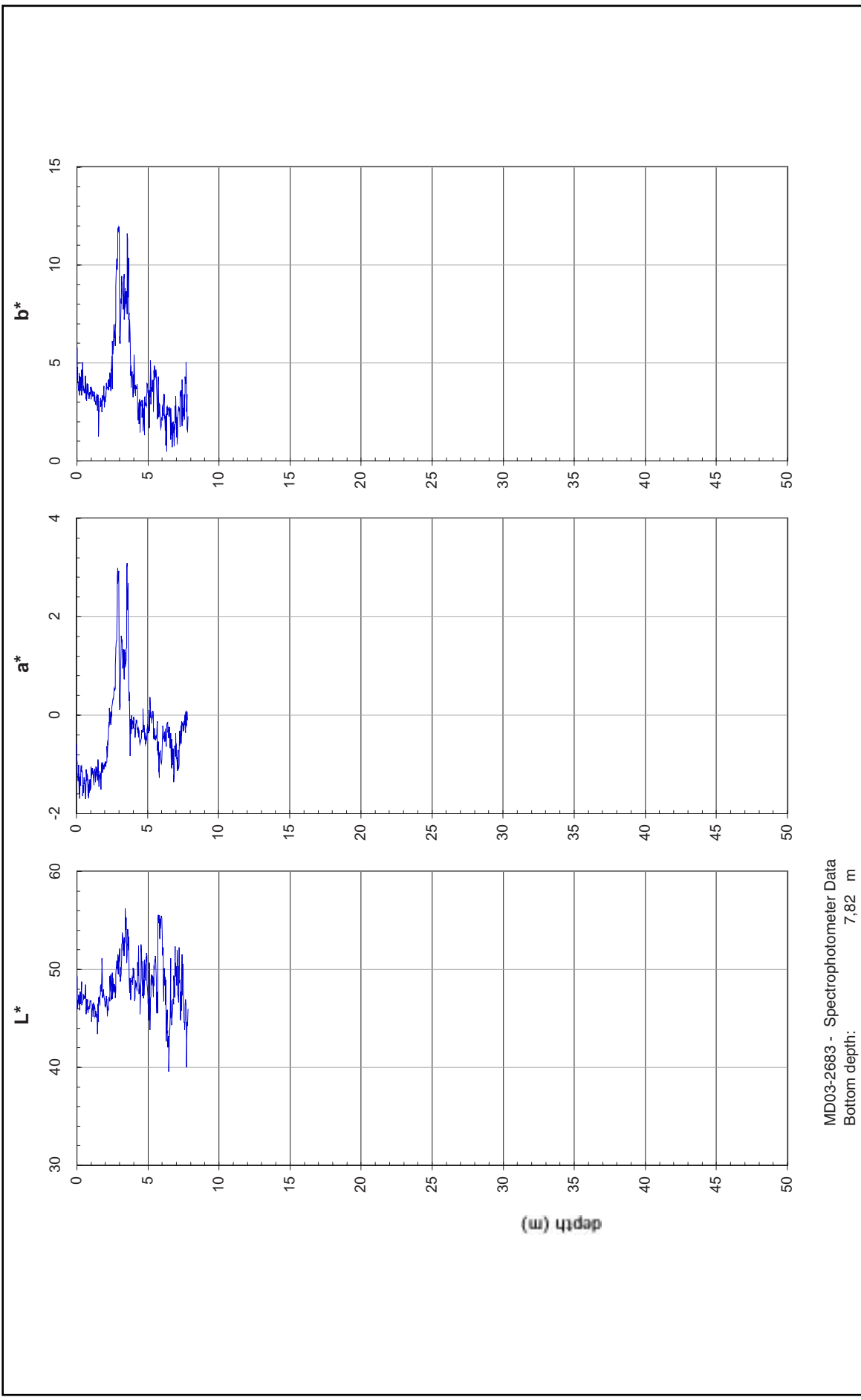

MD03-2684

20.06.2003, 11h17 UTC

Core length: 11,30 m

Lat: 60°24'08 N Lon:

23°38'39 W

Water depth : 1979 m



CORE SITE MD03-2684

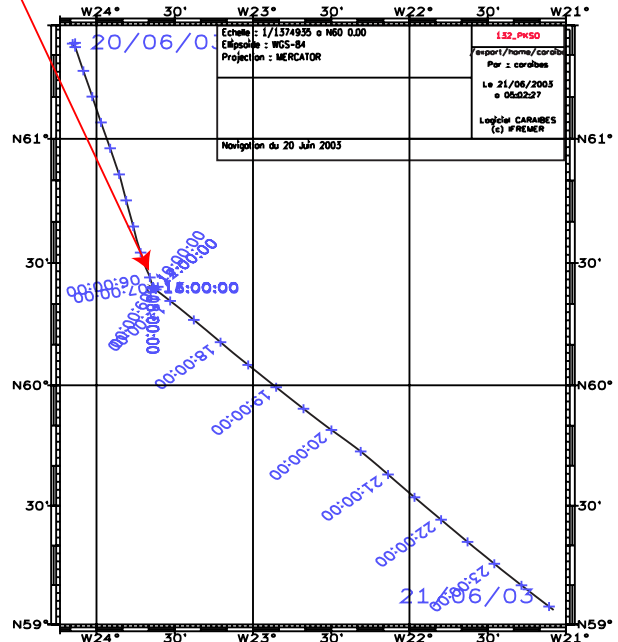
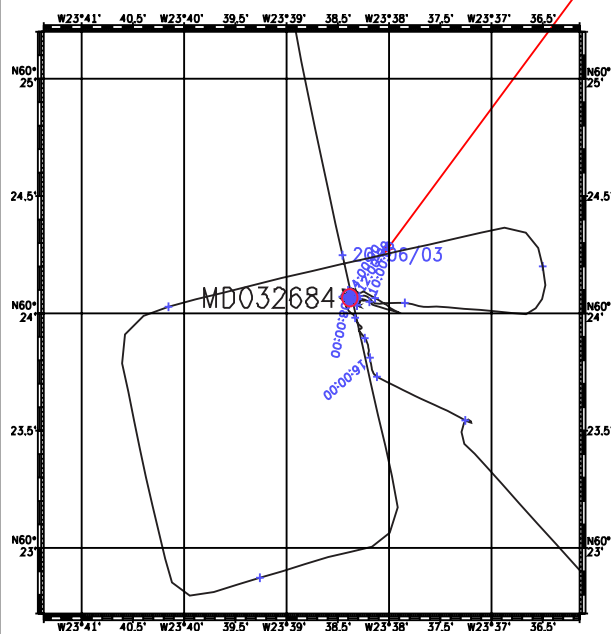

20/06/2003 11:37:17 z 60°24.07'N 023°38.44'W 260.3° 00.2 nds 969 m (Approch) rec 91289

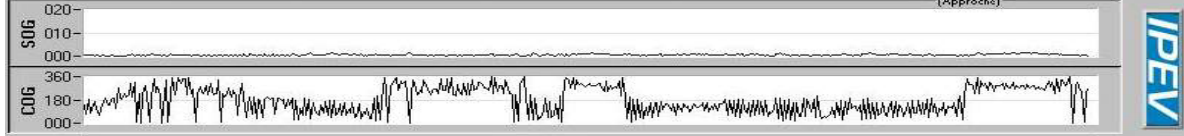

11:04:58 z 60°24.08'N 023°38.37'W	11:11:02 z 60°24.07'N 023°38.39'W	MD03-2684 11:17:02 z 60°24.07'N 023°38.40'W	11:25:01 z 60°24.07'N 023°38.41'W
---	---	--	---

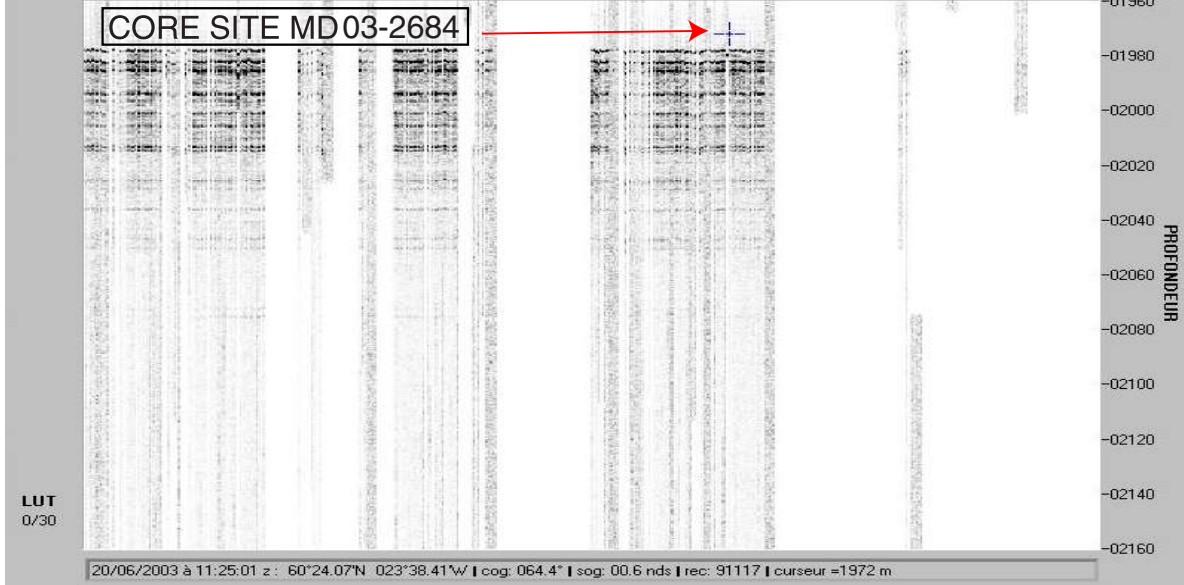

NOM DE LA CAMPAGNE
MD 132/P.I.C.A.S.S.O.

DATE 20.06.2003
N° de station : 58

Météo : (force) / Direction
Vent : **18 nœuds**
Mer : **Peu agitée**
Variation tension (maxi) :

CAROTTE (N°) :
MD 03-2684
(MD - année - milles - centaines)

CAROTTE (longueur) :
11.30 m

POSITION :
Latitude : **60°24.08 N**
Longitude : **023°38.39 W**

CAROTTIER (type) ⁽¹⁾ : **CASQ**

Poids total (air) : **7.40 t**

Poids total (eau) : **6.50 t**

REGLAGES :
Tubes (longueur) : **12.00 m**
Câbles :
Chute libre : **m**
Boucle : **m**
LC poids : **m**

CONTREPOIDS :
Type (2) :
Longueur PVC : **m**
Pénétration : **m**
Longueur de carotte + Ogive (+ 0,15 m) **m**

PARAMETRES MESURES :
Sonde corrigée : **1 979.00 m**
Ligne filée : **1 980.00 m**
Arrachement/total (tonne) : **t**
Arrachement/différentiel (tonne) : **t**
Pénétration/apparente (m) : **m**
Pénétration/tensiomètre (m) : **m**

HEURES (GMT)
En station : **Déjà en station**
Début manœuvre : **10:49**
Touchdown : **11:17**
Fin de manœuvre : **12:28**
Durée de manœuvre : **01:39**
Départ station : **Resté en station**

INSTRUMENTATION OPERATIONS ANNEXES
Pinger :
Flux de chaleur :
CTD (hydro) :
CTD (bouteilles) :
Filet à plancton :
Autres :

Description / incidents :

0	150	300	450	600	750	900	1050
I	II	III	IV	V	VI	VII	

1050	1200
VIII	
1130-FINI	

(1) CALYPSO - CALYPSO GRAVI/FLUX - BOX CORER 1/4m ou carré géant

(2) Cylindrique 100 kg / Plat / Préleveur

MD03-2684 (sections I to VIII)

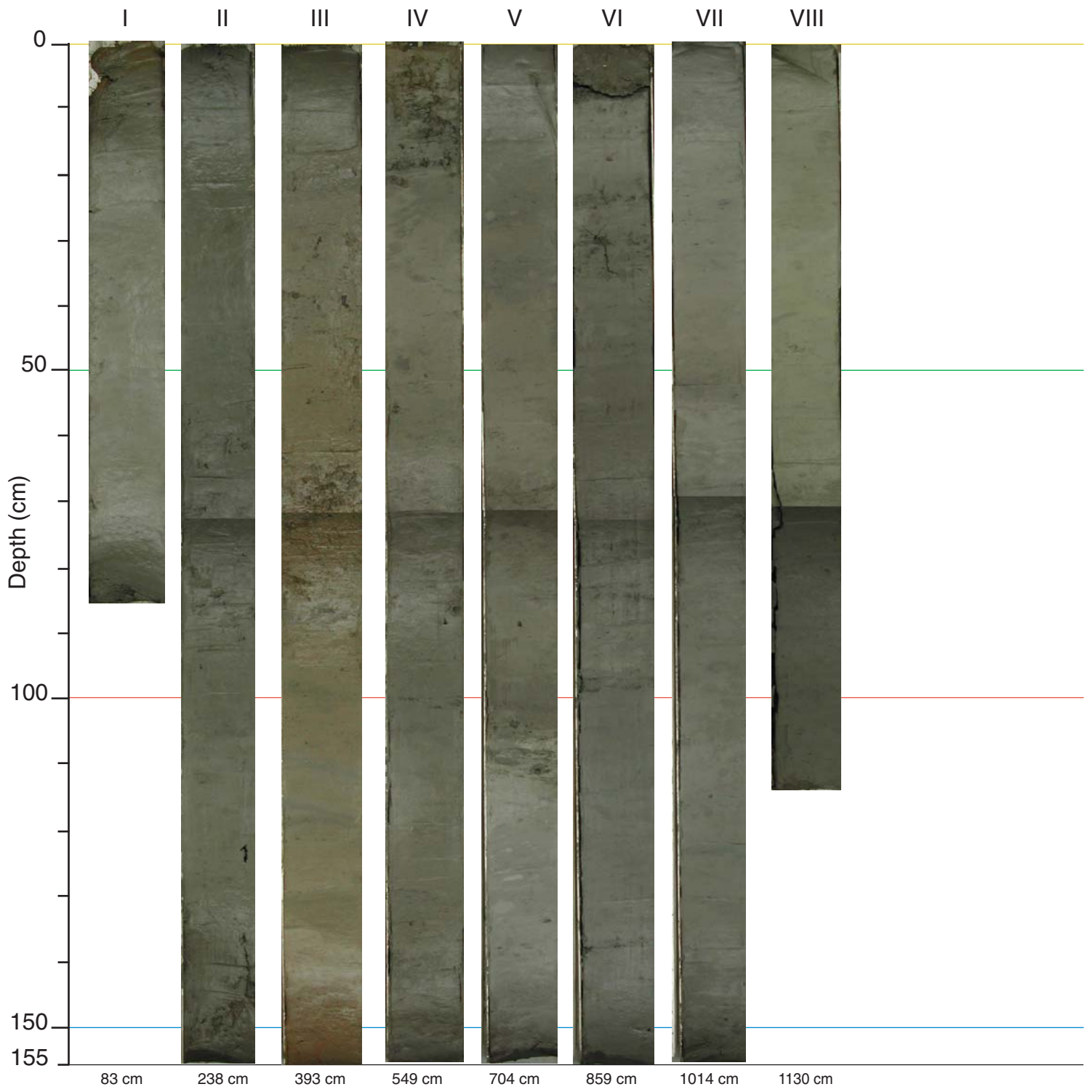

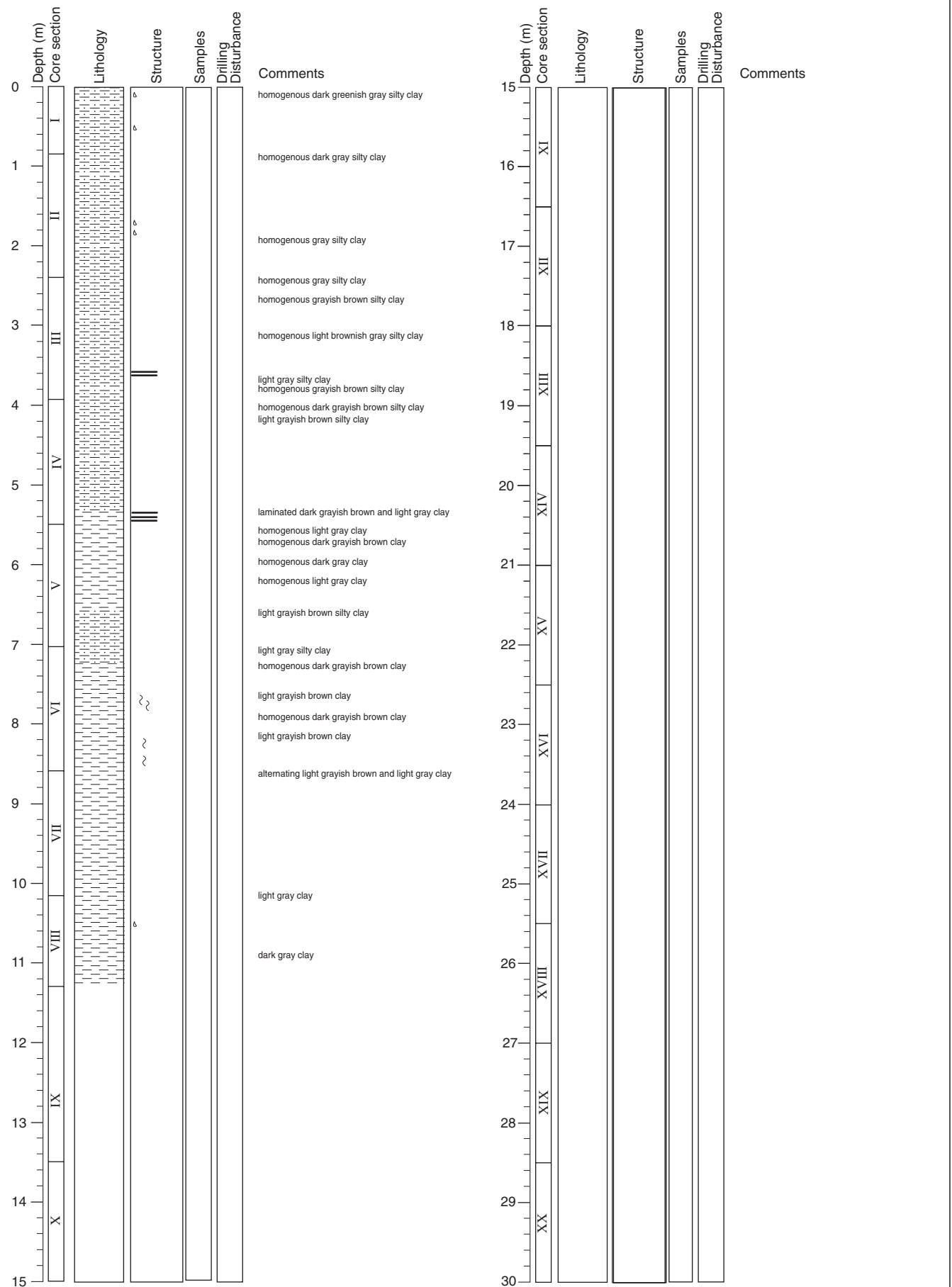

**IMAGES XI, 2003
PICASSO**

Colour Reflectance

**Station 58
Core MD03-2684C2**

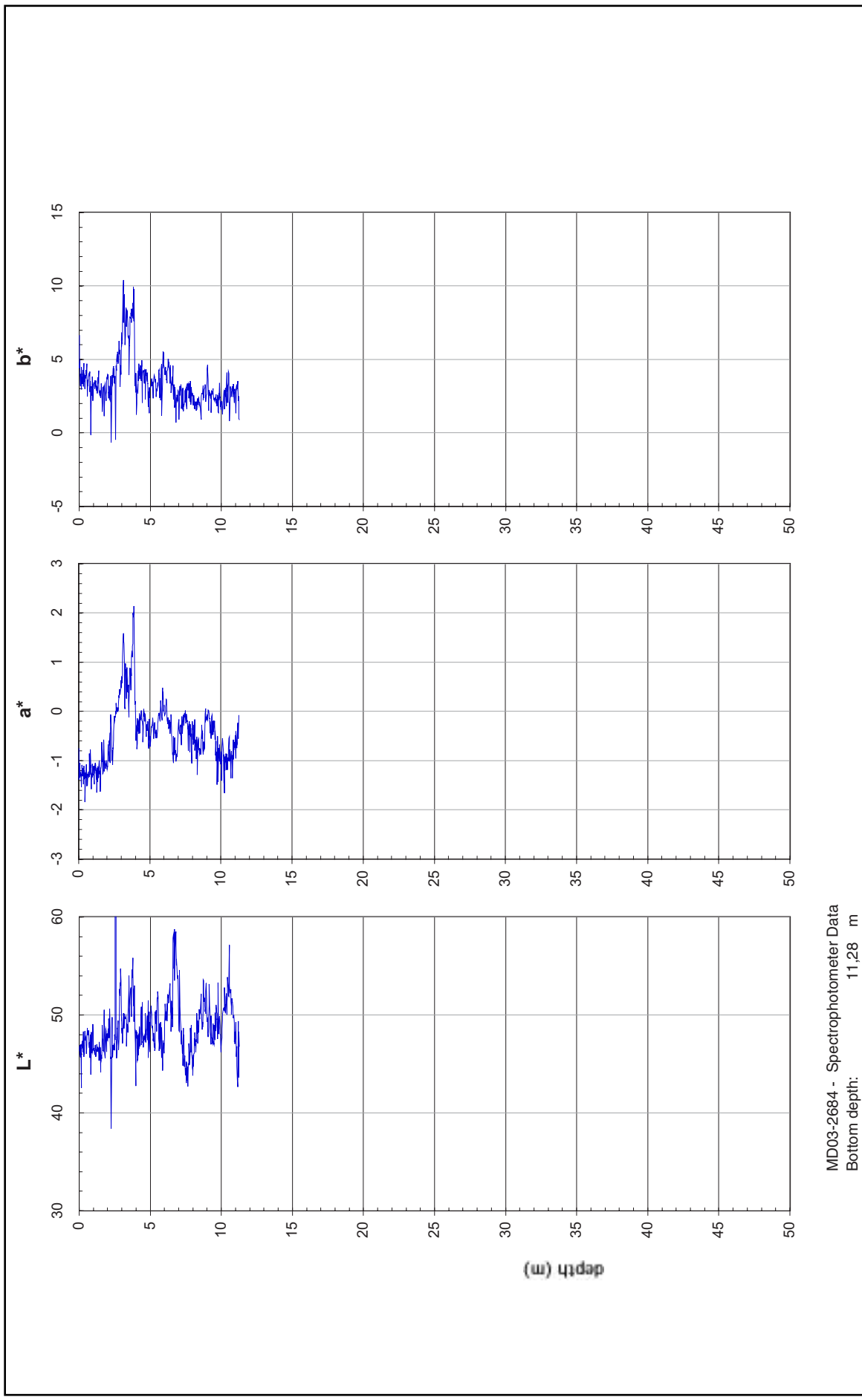

MD03-2684 - Spectrophotometer Data
Bottom depth: 11,28 m

MD03-2685

20.06.2003, 15h04 UTC

Core length: 44,61 m

Lat: 60°24'08 N Lon:

23°38'39 W

Water depth : 1977 m



CORE SITE MD03-2685

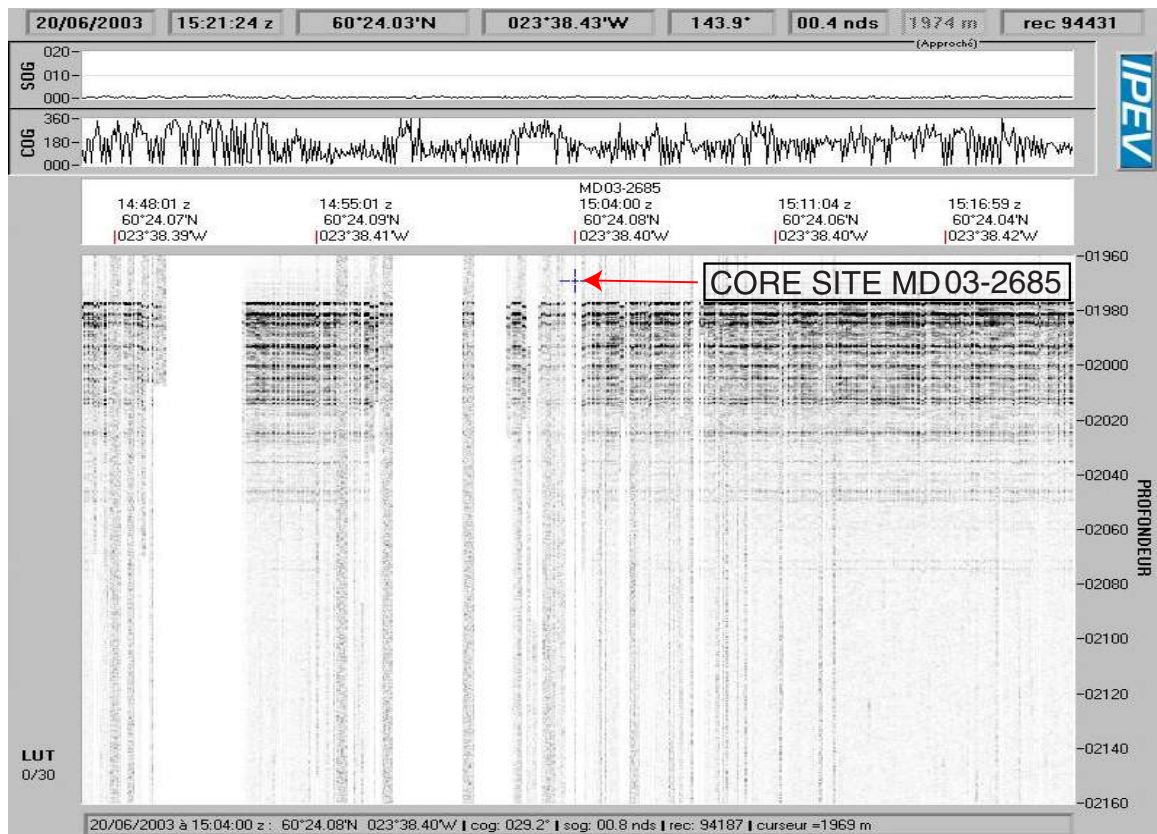
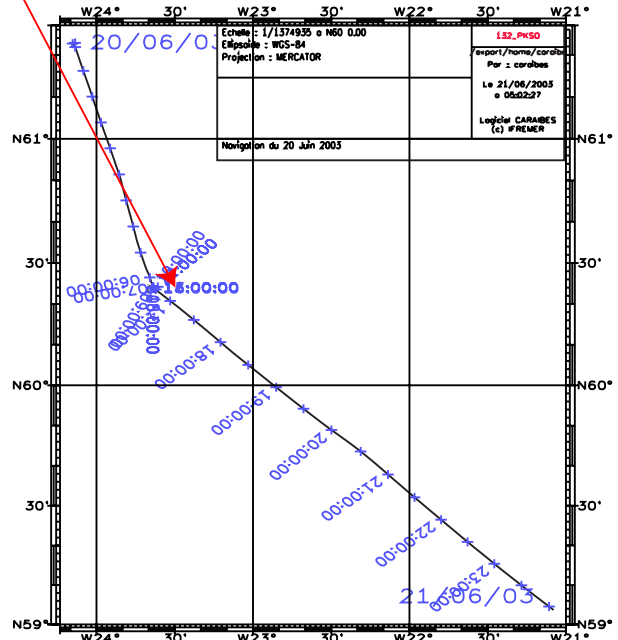
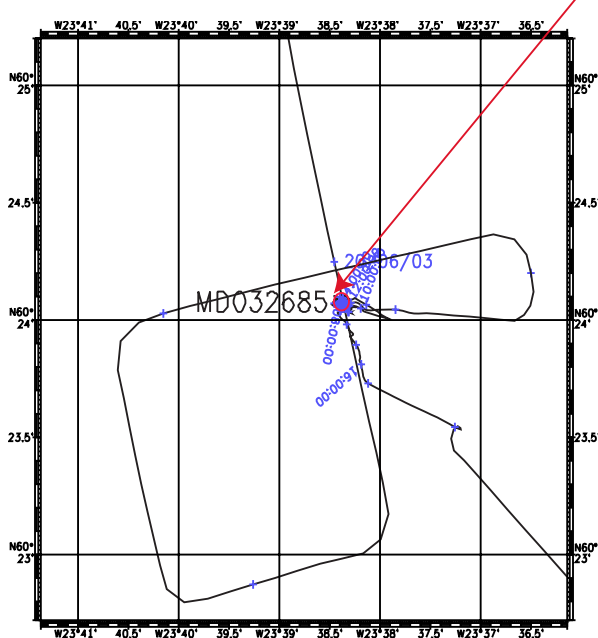

NOM DE LA CAMPAGNE
MD 132/P.I.C.A.S.S.O.

DATE 20.06.2003
N° de station : 58

Météo : (force) / Direction
Vent : 13 nœuds
Mer : Calme
Variation tension (maxi) :

CAROTTE (N°) :
MD 03-2685
(MD - année - milles - centaines)

CAROTTE (longueur) :
44.61 m

POSITION :
Latitude : 60°24.08 N
Longitude : 023°38.39 W

CAROTTIER (type) (1) : CALYPSO
Poids total (air) : 7.40 t
Poids total (eau) : 7.80 t

REGLAGES :
Tubes (longueur) : 48.60 m
Câbles :
Chute libre : 0.60 m
Boucle : 1.60 m
LC poids : 52.10 m

CONTREPOIDS :
Type (2) :
Longueur PVC : m
Pénétration : m
Longueur de carotte + Ogive (+ 0,15 m) : m

PARAMETRES MESURES :
Sonde corrigée : 1 977.00 m
Ligne filée : 1 933.00 m
Arrachement/total (tonne) : t
Arrachement/différentiel (tonne) : t
Pénétration/apparente (m) : m
Pénétration/tensiomètre (m) : m

HEURES (GMT)
En station : Déjà en station
Début manœuvre : 14:00
Déclenchement : 15:04
Fin de manœuvre : 16:35
Durée de manœuvre : 02:35
Départ station : 16:45

INSTRUMENTATION OPERATIONS ANNEXES
Pinger : OUI
Flux de chaleur :
CTD (hydro) :
CTD (bouteilles) :
Filet à plancton :
Autres :

Description / incidents :

0	150	300	450	600	750	900	1050
I	II	III	IV	V	VI	VII	
1050	1200	1350	1500	1650	1800	1950	2100
VIII	IX	X	XI	XII	XIII	XIV	
2100	2250	2400	2550	2700	2850	3000	3150
XV	XVI	XVII	XVIII	XIX	XX	XXI	
3150	3300	3450	3600	3750	3900	4050	4200
XXII	XXIII	XXIV	XXV	XXVI	XXVII	XXVIII	
4200	4350	4500					
XXIX	XXX						
	4461-FINI						

(1) CALYPSO - CALYPSO GRAVI/FLUX - BOX CORER 1/4m ou carré géant

(2) Cylindrique 100 kg / Plat / Préleveur

MD03-2685 (sections I to XV)



MD03-2685 (sections XVI to XXX)

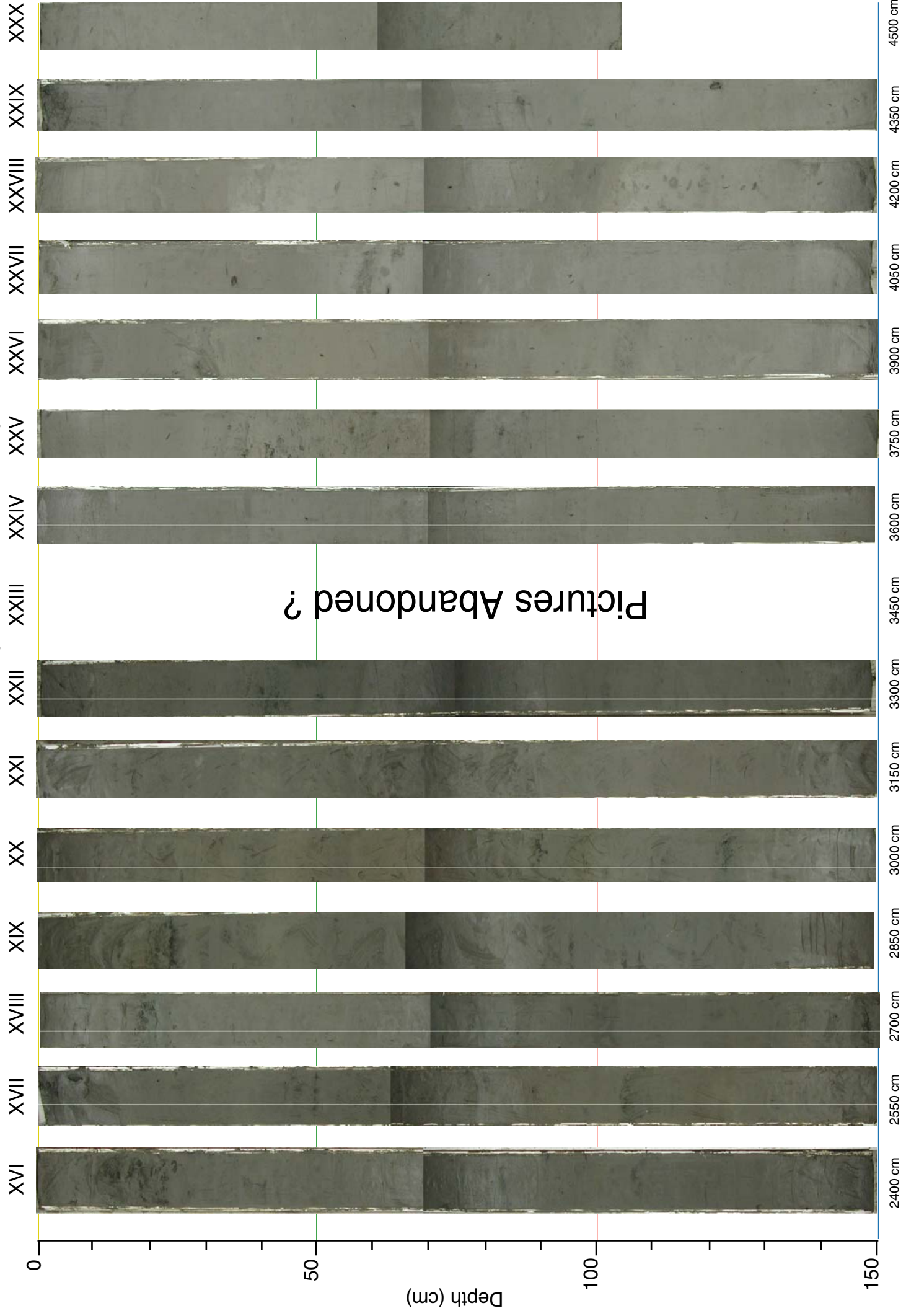

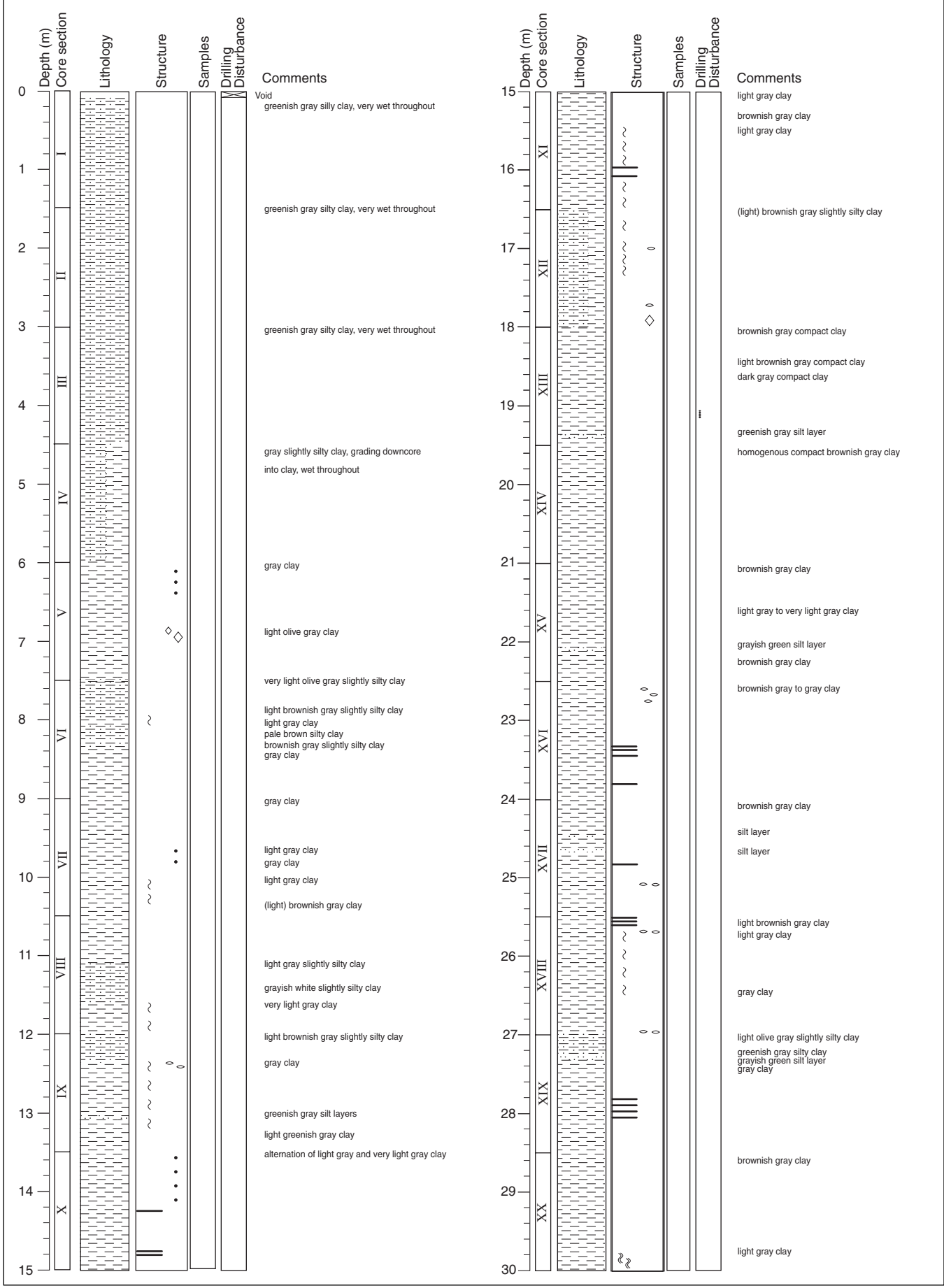

**IMAGES XI, 2003
PICASSO**

Multi Sensor Core Logger

**Station 58
Core MD03-2685**

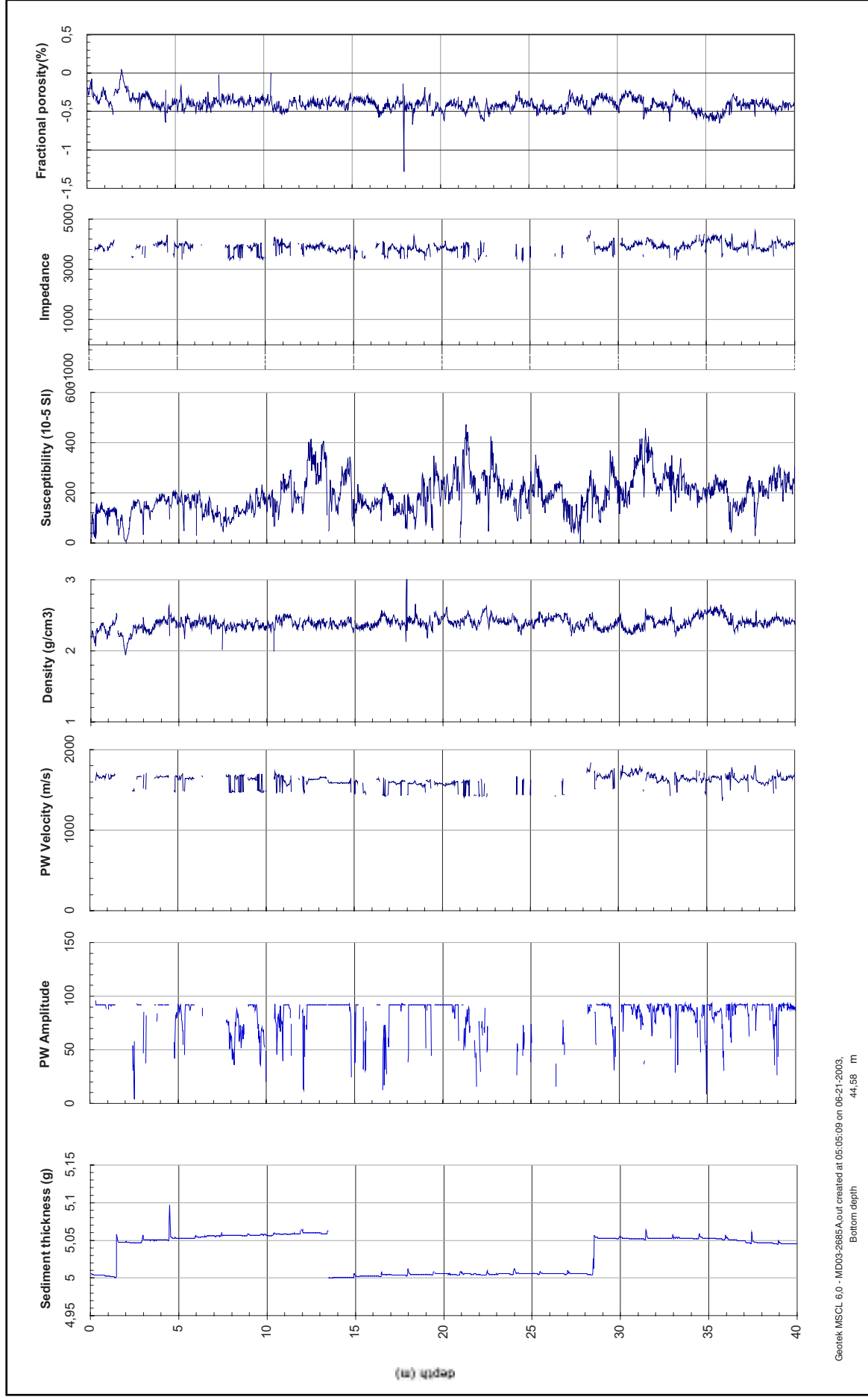

**IMAGES XI, 2003
PICASSO**

Colour Reflectance

**Station 58
Core MD03-2685**

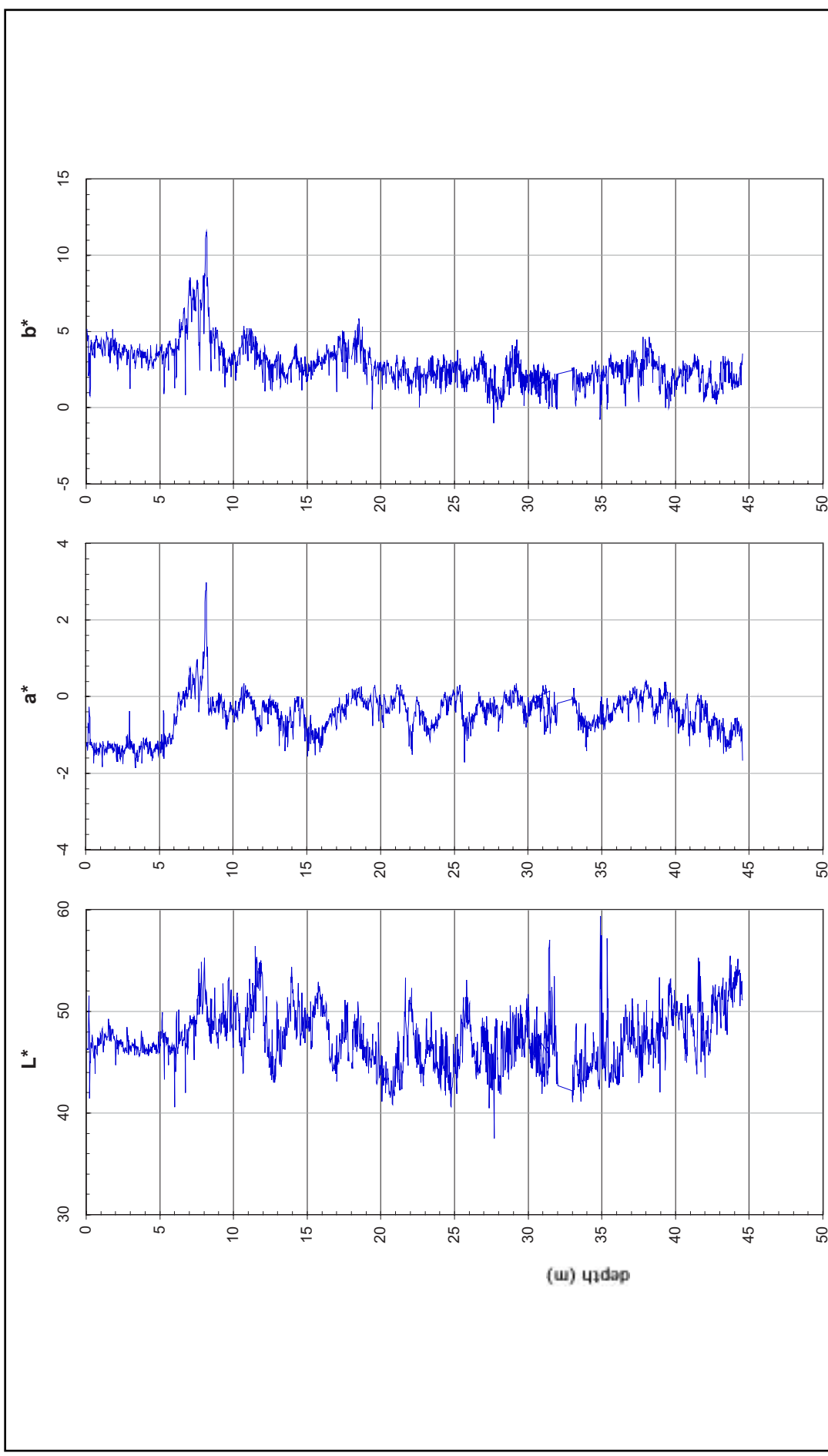

MD03-2685 - Spectrophotometer Data
Bottom depth: 44,56 m



Baltimore June 2003



50 Schoolchildren Exploring the Marion Dufresne



Dépôt légal : 2ème trimestre 2004

ISSN : 1246-7375

ISBN : 2-910180-33-6