



BioMoon: a concept for a mission to advance space life sciences and astrobiology on the Moon

Charles S. Cockell¹ · David A. Green^{2,3,4} · Nicol Caplin⁵ · Jessica Grenouilleau⁶ · Francesca E. McDonald⁷ · Marco Calvaruso⁸ · Daniela Billi⁹ · David C. Cullen¹⁰ · Matthew P. Davey¹¹  · Veronica De Micco¹² · Andreas Elsaesser¹³ · Timothy Etheridge¹⁴ · Christine Gläßer¹⁵ · Christine E. Hellweg¹⁶ · Crina S. Ilea¹⁷ · Antoine Lecocq¹⁸ · Natalie Leys¹⁹ · Javier Martin-Torres²⁰ · Miracle Nazarious²⁰ · Claudia Pacelli²¹ · Cyrille Przybyla²² · Elke Rabbow¹⁶ · Kate Robson Brown^{23,24} · Alvaro Soria-Salinas²⁵ · Nathaniel Szewczyk²⁶ · Walter Tinganelli²⁷ · Erin M. Tranfield^{28,29} · Jean-Pierre de Vera³⁰ · Cyprien Verseux³¹

Received: 12 July 2024 / Accepted: 7 October 2024

Published online: 28 October 2024

© The Author(s) 2024 

✉ Charles S. Cockell, c.s.cockell@ed.ac.uk; Nicol Caplin, nicol.caplin@esa.int; Francesca E. McDonald, francesca.mcdonald@esa.int; Marco Calvaruso, marco.calvaruso@cnr.it; marco.calvaruso@ibfm.cnr.it; Daniela Billi, billi@uniroma2.it; David C. Cullen, d.cullen@cranfield.ac.uk; Matthew P. Davey, matt.davey@sams.ac.uk; Veronica De Micco, demicco@unina.it; Andreas Elsaesser, a.elsaesser@fu-berlin.de; Timothy Etheridge, t.etheridge@exeter.ac.uk; Christine Gläßer, christine.glaesser@cgi.com; Christine E. Hellweg, christine.hellweg@dlr.de; Antoine Lecocq, antoine@plen.ku.dk; Natalie Leys, Natalie.Leys@sckcen.be; Javier Martin-Torres, javier.martin.torres@csic.es; Miracle Nazarious, miracle.nazarious@abdn.ac.uk; Claudia Pacelli, claudia.pacelli@asi.it; Cyrille Przybyla, cyrille.przybyla@ifremer.fr; Elke Rabbow, elke.rabbow@dlr.de; Alvaro Soria-Salinas, alvaro.soria-salinas@esa.int; Nathaniel Szewczyk, szewczyk@ohio.edu; Walter Tinganelli, w.tinganelli@gsi.de; Erin M. Tranfield, erin.tranfield@vib.be; Cyprien Verseux, cyprien.verseux@zarm.uni-bremen.de | ¹Centre for Astrobiology, School of Physics and Astronomy, University of Edinburgh, Edinburgh, UK. ²KBR, Wyle Laboratories GmbH, Cologne, Germany. ³Centre of Human and Applied Physiological Sciences, King's College London, London SE1 1UL, UK. ⁴Institute for Risk and Disaster Reduction, University College London, London WC1E 6BT, UK. ⁵Human Exploration Science Office, Directorate of Human Spaceflight and Robotic Exploration, European Space Agency (ESA), Noordwijk, Netherlands. ⁶European Space Agency (ESA), Paris, France. ⁷Lunar Science Office, Directorate of Human Spaceflight and Robotic Exploration, European Space Agency (ESA), ESTEC, Keplerlaan 1, 2201 AZ Noordwijk, Netherlands. ⁸Institute of Molecular Bioimaging and Physiology, Italian National Research Council (IBFM-CNR), Cefalù, Italy. ⁹Department of Biology, University of Rome Tor Vergata, Rome, Italy. ¹⁰Space Group, School of Aerospace, Transport & Manufacturing, Cranfield University, Bedford MK43 0AL, UK. ¹¹Scottish Association for Marine Science (SAMS), Oban, Argyll PA37 1QA, UK. ¹²Department of Agricultural Sciences, University of Naples Federico II, Portici (Naples), Italy. ¹³Department of Physics, Experimental Biophysics and Space Sciences, Freie Universitaet Berlin, Berlin, Germany. ¹⁴Faculty of Health and Life Sciences, Department of Sport and Health Sciences, University of Exeter, Exeter, UK. ¹⁵CGI Deutschland B.V. & Co. KG, 64295 Darmstadt, Germany. ¹⁶Department of Radiation Biology, Institute of Aerospace Medicine, German Aerospace Center (DLR), 51147 Cologne, Germany. ¹⁷Clara Venture Labs, Fantoftveien 38, 5072 Bergen, Norway. ¹⁸Department of Plant and Environmental Sciences, University of Copenhagen, Thorvaldsensvej 40, 1871 Frederiksberg C, Denmark. ¹⁹Microbiology Research Group, SCK CEN Belgian Nuclear Research Center, Mol, Belgium. ²⁰Department of Planetary Sciences, School of Geosciences, University of Aberdeen, Meston Building, King's College, Aberdeen AB24 3UE, UK. ²¹Science & Research Directorate, Italian Space Agency (ASI), Rome, Italy. ²²Ifremer, IRD, MARBEC, Univ Montpellier, CNRS, Palavas-Les-Flots, France. ²³School of Mechanical and Material Engineering, College of Engineering and Architecture, College of Belfield, University College Dublin, Dublin, Ireland. ²⁴School of Engineering Mathematics and Technology, Faculty of Science and Engineering, University of Bristol, Bristol, UK. ²⁵International Space Station Operations Team, Directorate of Human and Robotic Exploration Programmes, European Space Agency (ESA), Munich, Germany. ²⁶Ohio Musculoskeletal and Neurological Institute, Heritage College of Osteopathic Medicine, Ohio University, Athens, OH, USA. ²⁷Biophysics Department, GSI Helmholtzzentrum Für Schwerionenforschung, Darmstadt, Germany. ²⁸Instituto Gulbenkian de Ciência (IGC), Oeiras, Portugal. ²⁹VIB-UGent Center for Inflammation Research, Ghent, Belgium. ³⁰German Aerospace Center (DLR), Space Operations and Astronaut Training, MUSC, Cologne, Germany. ³¹Center of Applied Space Technology and Microgravity (ZARM), University of Bremen, Bremen, Germany.



Abstract

As humans advance their presence in space and seek to improve the quality of life on Earth, a variety of science questions in support of these two objectives can be answered using the Moon. In this paper, we present a concept for an integrated mission focused on answering fundamental and applied biological questions on the Moon: BioMoon. The mission was designed to investigate the effects of the lunar radiation, gravity, and regolith on biological systems ranging from biomolecules to systems with complex trophic interactions, spanning a range of model organisms. Using common analytical systems and data processing, BioMoon represents a systems-level integrated life sciences mission. It would provide fundamental insights into biological responses to the lunar environment, as well as applied knowledge for In-Situ Resource Utilisation (ISRU), closed-loop life support system development, planetary protection and human health care. The mission was conceived to test biotechnology and sensor technology for lunar and terrestrial application and provide education and outreach opportunities. Although BioMoon was considered in the context of the European Space Agency's Argonaut (European Large Logistics Lander) concept, the mission design provides a template for any integrated life sciences experimental suite on the Moon and other celestial bodies, implemented either robotically or by human explorers.

1 Introduction

The increasing international interest in expanding the robotic exploration of the Moon, and in reinstating a human presence there, is driving a plethora of scientific and technological requirements. In the process, humanity will acquire key skills and knowledge that will enable us to reach destinations beyond the Moon, such as Mars. In addition, such missions will undoubtedly produce technology and knowledge of benefit on Earth. The enormous number of scientific questions that can be addressed via a presence on the Moon have been elaborated [1–7]. Amongst the high priority areas of interest are investigations in biosciences such as determining the effect of the (dynamic) lunar environment on biomolecular integrity, and how closed-loop life support systems can be generated and sustained in such an environment.

As part of its Human and Robotic Exploration (HRE) strategy, the European Space Agency (ESA) has sought opportunities to contribute to lunar exploration activities, including providing the Service Module of NASA's Orion spacecraft, and several elements for the Lunar Gateway (Space Station) including the iHAB module. In addition, ESA developed, as a next step on from the multinational HERACLES (Human-Enhanced Robotic Architecture and Capability for Lunar Exploration and Science) programme, the concept of a European Large Logistic Lander (EL3), since then renamed Argonaut, designed to enable the delivery of cargo and/or science packages to the lunar surface in the 2030s. The EL3's nominal payload mass was envisaged to be ~ 350 kg, within an overall mass of 1,500 kg. To evaluate the feasibility, desirability and design requirements of this concept, ESA instigated a call for candidate scientific questions that could be addressed by European research activities aboard such a spacecraft. This process led to the development of several working groups in subdisciplines, one of which coalesced around biological questions. From this working group, the concept of an integrated biologically-focussed mission was born, termed BioMoon.

The BioMoon Concurrent Design Facility (CDF) study focused on the concept of a single EL3 mission that could accommodate an integrated bioscience mission with a variety of payloads, from microorganisms to animals, with the purpose of investigating the effects of the lunar environment on biological systems. We seek to describe the overall mission concept here. Regardless of the eventual plans for European lunar landing capability, the principles elaborated for BioMoon are applicable to any exploration concept for an integrated robotic life sciences and astrobiology mission to the Moon. Therefore, the scientific questions, and hypotheses behind the experiments proposed, are not specific to the EL3 robotic concept and could be considered for any scientific programme performed on the Moon.

2 Scientific and educational rationale of BioMoon

The BioMoon mission concept was considered as an integrated biosciences mission to operate across a single lunar day (14 Earth days) and night (14 days). It would provide a platform that addressed both fundamental science and applied (operational) biological questions, the latter primarily in support of human habitation on the Moon, including In-Situ Resource Use (ISRU) and life support systems. Its main objective would be to serve as a robotic laboratory to investigate the effects of the lunar environment upon biology, namely: lunar gravity (0.16 g), dynamic radiation (lunar weather), and the lunar regolith, via experiments incorporating a range of representative biological systems and/or organisms relevant

to human activity on the Moon. However, such experiments also have applications on Earth, in Low Earth Orbit (LEO) and in locations beyond the Moon, including Mars.

Most biological experiments in space (e.g., on the International Space Station) are performed as standalone investigations by specific principal investigators (PIs) and their team. As a result, missions to the Moon, both space agency-driven and commercial, have been envisaged to provide opportunities for individual biological experiments through selection calls. However, a weakness in this approach is the launch of disconnected experiments using different hardware, and if they are on different missions, they will be exposed to differing environmental conditions (e.g., space weather). Given the inherent complexity of biological systems, these differences could potentially make it difficult, or even impossible, to adequately compare and contrast data in order to derive generalised understanding and models of biological systems behaviour in lunar conditions.

In contrast, the BioMoon mission was envisaged to comprise a set of experiments that can be compared since they will operate under similar or identical conditions, and will be analysed by the same instruments. This approach allows for a synthetic set of comparable data across these systems, achieving a 'systems' understanding of how biological materials operate in the lunar environment. That said, each of the individual experimental payloads described here can in principle be implemented as a separate bioscience experiment for deployment to the Moon.

The BioMoon mission was designed to investigate biological systems across the range of complexity found in biological systems, namely: molecules (including complexity within a range of molecules from prebiotic molecules of interest such as amino acids through to complex pigments of astrobiological interest), prokaryotic organisms (bacteria and archaea), eukaryotic single-celled organisms (algae), and eukaryotic multi-cellular organisms ranging through plants, insects, fish and mammalian cell systems. In addition to the complexity in the individual organisms and their phylogenetic diversity, BioMoon was designed to test the effects of the lunar environment on the complexity of interactions, ranging from isolated biomolecules, through to model ecosystems with multiple trophic levels. Figure 1 shows how the scientific vision of the BioMoon mission is underpinned by the concept of three axes of complexity: cellular, community, and phylogenetic (a diverse range of organisms) relevant to a human presence on the Moon.

The BioMoon mission was especially focused on the three key areas in which there remains a significant dearth of knowledge: the effect of lunar gravity (0.16 g), the dynamic and complex radiation environment, and the lunar regolith environment on biological systems.

Despite the Apollo missions incorporating three-day sojourns on the lunar surface and robotic missions since then, we have very little knowledge of how partial lunar gravity influences biological systems [8]. In fact, almost all studies in space and in ground-based analogues have focused on microgravity in LEO, where significant multi-systems deconditioning is observed; albeit with significant intra-individual variability [9]. Furthermore, there have been very few studies evaluating multiple *g* levels in whole organisms, including in humans, owing to methodological challenges. However, it is clear that the biological effects of gravity are not linear, and one cannot merely interpolate the gravity level between microgravity and terrestrial (1 g) gravity to determine the effects of lunar gravity [10].

Fig. 1 Conceptual illustration of the way in which the BioMoon mission would investigate different axes of complexity in biosciences, including cellular complexity (which is taken here to include the astrobiological study of simple and complex molecules), community complexity (including trophic levels), and a diverse range of organisms (phylogenetic complexity) relevant to a human presence on the Moon

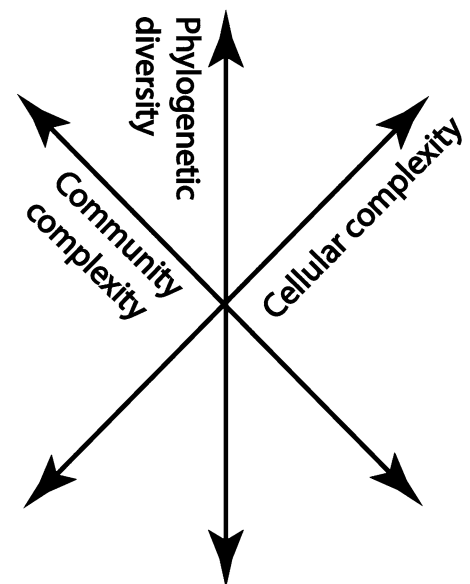

Whilst lunar regolith is an identified biological crew hazard [11], we have little understanding of how such material interacts with biological systems and its potential to support microbial or plant growth [12]. Equipped with an arm for collecting local regolith material, BioMoon was envisaged to possess the capability to add (local) regolith into experimental containers to investigate its interactions with model biological systems. Given the importance of the regolith environment, this issue is addressed on its own below.

With respect to radiation, the lack of protection from an atmosphere or a magnetic field exposes organisms to the largely unattenuated solar and galactic radiation flux [3, 13–15]. The background radiation field on the Moon comprises: solar wind particles, high energy galactic cosmic rays, and sporadic high energy particles released during Solar Particle Events (SPEs) primarily made up of protons and helium nuclei. Most of these SPE particles have energies between 20 and 80 MeV, with some achieving GeV energies [3]. This contrasts with galactic cosmic rays (GCR), made primarily of protons, alpha particles and high Z particles which have energies between 1 and 10^4 GeV which also have the potential for significant biological damage [16]. Despite the many radiation experiments which have been conducted on Earth, they are limited to certain radiation types and energies that are not necessarily good representations of the space environment and are usually focused on high intensity ionizing radiation doses. In LEO, numerous studies have evaluated organism survival [17], but we still have very little understanding of the effects of the complex interplanetary radiation environment on biology, including the potential production of secondary particles from interactions of high energy particles with the lunar surface. Modelling of such risks is vital for exploration missions [18].

In addition to these complexities, the interactions of hypogravity, radiation and lunar regolith are entirely unknown. Although there is work dating back to the Apollo era on the effects of the lunar environment on biological systems [19], there is an urgent need for more comprehensive and comparable data across different biological systems gathered using modern analytical methods to derive information not just on single factors, but their *interaction*, that can be used to significantly advance our fundamental scientific understanding of molecular mechanisms and to provide data for predictive models to support human operations beyond LEO where novel solutions [20] to the challenges of resource availability will be required [21].

2.1 The rationale for using regolith in bioscience experiments

A core component of the BioMoon concept was considered to be the evaluation of the effect of ‘fresh’ regolith on biological systems in order to establish whether lunar regolith can be used effectively as a substrate to provide nutrients for life support systems, and if bioprocesses (e.g., microbial interactions) can act upon it to yield molecules of utility for a human presence on the Moon.

Lunar regolith consists of impact gardened rock which has been pulverised over millions of years to form a regolith layer whose thickness may be several metres in some locations. Although surface material may comprise of boulders through to sand-sized fragments, it is also co-located with fine dusty material with a grain diameter typically between 45 and 100 μm . Owing to the absence of liquid water to quench broken reactive silica bonds, this dust may have chemically reactive surfaces, which can interact with biological material. Furthermore, molecular sharp edges (uneroded by wind and water) and the presence of diverse impact melt glass yield lunar regolith physical and chemical profiles dissimilar to terrestrial weathered materials [3]. Thus, we cannot assume that our knowledge of biotic interaction with similar volcanic materials on Earth will translate into equivalent effects of lunar dust and regolith on a co-located biota.

Several studies have shown that lunar regolith (or its simulants) has a diversity of effects on biota [22–27], including augmented organism growth and/or yield, but also induction of cellular stress responses [27]. To investigate these effects in-situ, ‘fresh’ indigenous regolith that has been on the Moon and not stored in terrestrial conditions is optimal. Initial studies do not provide specific requirements for a particular sub-type of lunar regolith, but a sample of collected material (e.g., basaltic, anorthositic) must be characterised.

Lunar soil simulants flown to the Moon for the purposes of lunar surface experiments are not adequate for studying the effects on biology because simulants only approximate aspects of the composition of lunar regolith. The nature of the lunar regolith and its activity cannot be recreated on the Earth, for example by exposing lunar material or simulants to ionising or ultraviolet (UV) radiation since regolith material on the Moon has been subjected to the combined effects of the radiation environment, low pressures (which may encourage devolatilization of some compounds) and impact shock processing, which can change mineralogy through pressure and temperature effects (including the formation of glasses). Thus, the only way to appropriately investigate the effects of lunar regolith and dust on biological systems is to use fresh material collected on the lunar surface itself and included into the relevant experimental conditions.

Furthermore, BioMoon would require several tens of grams of regolith to carry out the proposed experiments, which is not compatible with the quantity of Apollo regolith material that is readily accessible or the quantity of material available from Chinese lunar sample return. Even if acquiring that quantity was possible, in the case of Apollo material, it has been stored for several decades and some of its pristineness is compromised [28]. The consequences of this for its biological activity and interaction with biological systems compared with fresh material are unknown.

There is a risk that surface material would be blown away during the landing of BioMoon, however subsurface material is likely to be adequate for the purposes of the mission. The science team also considered contamination around a proposed landing site with rocket propellant from the landing exhaust. The effects of the propellant on biological experiments should be tested in the laboratory to determine any potential effects prior to the mission to generate evidence-based mission sample requirements. However, it was agreed that on-balance the use of 'fresh' indigenous regolith, even with this potential chemical contamination, would be preferable and thereby yield the most valuable science.

2.2 Scientific hypotheses

With these observations in mind, three core hypotheses were defined for the BioMoon mission:

(1) Hypothesis 1: Biological systems, including molecular targets, individual species (across diverse types of organisms (taxa) and cellular complexity), and whole ecosystems, respond differently to the individual environmental factors associated with the lunar surface (hypogravity, radiation, and regolith). This is especially the case when the factors interact. Some of these changes are common across organisms (all life), but some differ depending on taxa and/or cellular complexity. Understanding such responses is vital to advance predictive models of the effects of the lunar environment on biological systems and/or complex organisms including humans, in addition to being informative to astrobiology, planetary protection initiatives, and a host of fundamental terrestrial and space life questions.

(2) Hypothesis 2: Biological systems, from individual species to integrated ecosystems, can be employed to perform processes and generate products of direct benefit to a sustainable human presence on the Moon such as life support and In Situ Resource Utilisation (ISRU), including biomineralisation and biomanufacturing.

(3) Hypothesis 3: Complex closed biological systems can be operated and sustained in space environments beyond LEO, including transit to and from, and when on the lunar surface.

These three hypotheses guided our preliminary design for the experimental payloads. It is noted that these hypotheses could form the basis of a more detailed science traceability matrix (STM) in a further iteration of such a mission concept.

2.3 Other aspects of the BioMoon mission

2.3.1 An integrated data vision

The three hypotheses should not be considered as separate hypotheses, but rather as complementary steps that overlap, not only in the type of experimental data obtained, but also the prospect of equivalent data being collected by identical instruments across different biological systems, facilitating an integrated comparative understanding of the interactions between biological systems. This vision is not without challenges, but the effort in carefully selecting instruments that are common to several of our proposed biological systems and suitable data processing pipelines will allow an efficient mission, generating robust data.

Existing microgravity experiments and their data analysis tend to be handled as separate scientific experiments. For BioMoon, we conceived of developing tools on Earth that allow for curation, archiving, sharing, analysis, modelling and visualising data across biological model organisms using similar data sets (such as from our genetic ('-omics), chemical, spectroscopic and imaging analysis) across all the different experiments. By having concurrent experiments with shared analytics, we might avoid the reproducibility issues that can be a problem with the comparability of science results across different missions and platforms.

Finally, our intent was that the BioMoon concept and associated data pipelines become a model to advance open science. By establishing a developer and user community we seek to generate tools, pipelines and questions that can be used to define future science experiments, missions, and architectures, identify associated risks, and contribute to the assessment of their feasibility.

2.3.2 Public outreach and education

The public interest in the human exploration of space and in the possibility of propelling life beyond LEO is substantial, and growing, in part due to the expansion of commercial spaceflight. Nevertheless, the funding of scientific payload development and exploitation of spaceflight typically remains largely nationally focussed [29]. In contrast, our approach is predicated on leveraging expertise that exists in numerous ESA member states, and potentially beyond, making the mission international in scope.

The BioMoon scientific objectives tend themselves to many educational objectives. By using molecular systems, organisms, and simple ecosystems, the mission cuts across numerous science, technology, engineering, and mathematics (STEM) subjects such as biological sciences, chemistry, physics, bioinformatics, engineering, and mathematics. Examples of curriculum areas covered by this mission include: (1) Factors determining the growth and viability of organisms, including photosynthetic organisms, (2) Behaviour of fluids, (3) Effects of radiation, (4) Chemistry of living things, (5) Measurements in biological and physical sciences, (6) Human spaceflight and its associated physical, chemical and biological challenges. In the latter case, topics in social sciences and humanities might also be addressed, such as the purpose of a human presence on the Moon.

We envisaged that BioMoon would be supported by a substantial education and outreach effort focused on the production of lesson plans and education materials for primary and secondary schools, linked to local, national and international curriculum benchmarks, education and outreach materials at university level, and an educational programme directed at segments of the population that are usually regarded as marginal in space science mission plans, for example the prison population [30].

3 Conceptual description of the payload

With our scientific hypotheses in mind, it was possible to consider the design of a robotic package that would enable us to test these hypotheses. From this conceptual foundation, it was then possible for the team to design the specific payloads within the context of the EL3 architecture. We present this conceptual view.

The first practical limitation to note about our hypotheses is that although the lunar radiation environment is higher than Earth's, the proposed duration of a robotic mission would require highly sensitive systems to detect the radiation dose. For example, over a mission duration of 14 Earth days, the total dose accumulated over the mission would be on the order of 20 mSv, based on the dose rate of ~ 1.4 mSv/d determined by LND (Lunar lander Neutron and Dosimetry (LND) experiment) during solar minimum [15]. However, we expect that even this dose will cause a unique biological dose deposition profile in different biological systems because of its higher dose rate, energy and complexity, compared to LEO or Earth. Carpenter et al. [3] suggest that the minimum time required to accumulate radiation damage that will yield useful experimental results is ~ 1 month and, of course, the longer the mission, the clearer radiation effects will become. Important in this respect is the dose rate as well as the accumulated dose which determines the time necessary to get experimentally meaningful results [31]. Against the engineering demands of our mission, we settled on a compromise of one full day-night cycle (i.e. 28 days) for total mission duration, noting the challenge of operation during the lunar night.

The complexity of the radiation environment originates from both primary radiation and secondary particles (primarily neutrons, gamma rays and nuclear fragments) generated by primary interactions with the lunar regolith. The radiation field beyond LEO can be characterised as a constant chronic low dose, with a low dose-rate but with potentially highly biologically significant variations (peaks) in time (such as during solar flares), that may also vary over the lunar cycle. The relative biological sensitivity to all these factors needs to be taken into account for human radiation risk assessment modelling. However, data required to generate or improve these models is lacking, for example dose–response curves, molecular mechanisms, molecular damage, and survival characteristics of different organisms. BioMoon would contain a substantial dosimetry focus to significantly improve data available on the radiation environment. This leads to the requirement for a specific dosimetry package which will be described.

Hypothesis 1 The first hypothesis would be addressed with a two-pronged approach:

- (1) An experiment rack containing a range of dormant biological samples to investigate the effects of accumulated UV and ionizing radiation damage in biological systems not undergoing repair. It will investigate how radiation affects biological systems in combination with local regolith. These data will yield new insights into the processes that lead

to radiation damage in biological systems and they will yield practical information on the fate of cells and component biological materials in the lunar environment, with applications to planetary protection (i.e. understanding the contamination risk and load from human activities on the Moon and on other planetary bodies such as asteroids and Mars where molecules will also be exposed to high levels of ionizing radiation), survival of biomolecules (signatures of life and their detectability) in all high radiation environments, and the way in which high extraterrestrial radiation environments influence the potential survival of life on other planetary bodies (e.g., habitability). These data may have application to other areas of astrobiology, for example, the origin of life and the transfer of life between planetary bodies in that these areas of research depend on a knowledge of molecular survival in space conditions.

- (2) An internal set of active growth experiments that will investigate the growth of organisms in lunar conditions and in combination with local dust/regolith collected by a robotic arm. The expected data from this set of experiments will advance knowledge of how lunar conditions influence key factors in the success of biological systems in space: i.e., 1) growth rates, 2) repair rates, 3) genetic changes that may alter functionality, 4) reproduction, 5) interactions with other organisms, 6) and 'long-term' functional adaptations.

Hypothesis 2 The (bio) processing of local materials is key to the long-term establishment of a self-sustaining, or at least a maximally self-sustaining, presence on the Moon. A key hardware element of the mission is a system for the delivery of lunar dust/regolith from the landing site to the internal experimental suite to investigate the interaction of actively growing model organisms with this material when simultaneously exposed to the gravity/radiation conditions on the Moon.

The experiments envisaged for Hypothesis 1 will be examined for Hypothesis 2 with respect to the processing of materials from the point of view of ISRU/life support systems. This includes specific payload analysis dedicated to this hypothesis. These analyses include:

1. Measurements of useful products within the samples themselves. These could include measurements of O₂ [32] in cyanobacterial and algal growth chambers, extrusion of fatty acids and proteins into solution (used as organic supplies in life support systems, for pharmaceutical production, or for the production of plastics).
2. The efficiency with which the organisms use the provided nutrients, for example the efficiency of the use of light and nutrients measured by growth rates, or CO₂ use.
3. The processing of regolith to use this material in life support systems, biomining, and other mineral in-situ resource applications.
4. The use of the analytical capability to examine samples from all the chambers (e.g. examining the ion content of fluids to measure the leaching rate from regolith and thus the bioprocessing of regolith by cyanobacteria, algae, bacteria and life support system growth chambers).

Given the possibility of a deleterious effect of regolith on growth, we envisage that the regolith would be added after the initial growth of organisms to address Hypothesis 1 to study whether leachate from regolith will influence already established organisms. Once sufficient scientific data has been acquired and organisms have been grown for adequate time to satisfy the hypothesis, regolith would be introduced into the culture chambers and the biological responses examined. Alternatively, separate chambers could be added to allow for an analysis of the effects of regolith on germination and growth from the start.

We note that apart from interactions with regolith, many other data gathered in Hypothesis 1 will be of direct importance to this Hypothesis (for example, O₂ production, fatty acid and secondary product production in bioreactors devoid of regolith). Thus, a successful advance in biological ISRU studies could be achieved in a scenario where regolith acquisition was not possible or the system failed.

Hypothesis 3 We can imagine the use of a wide range of biological systems on the Moon. However, key to the use of any of these systems is the ability to be transported to the lunar surface and to operate over extended time periods there. For example, can they be dehydrated or kept in storage before use? What is the effect of transportation from Earth? Can they be easily manipulated in space with reliable revival from a desiccated state? These are critical practical questions when selecting the biota for BioMoon but also for support of subsequent human missions. Some of these questions have already been addressed in biological experiments to the ISS and may be addressed in proposals to conduct biological

experiments at the Lunar Gateway. BioMoon would leverage such experiments and extend these questions to the lunar surface.

In this hypothesis, we investigate the viability, growth, adaptation and genetic data acquired in Hypothesis 2, but interpreted specifically with respect to the transport and use of organisms on the lunar surface to support and inform the definition of a sustained human presence.

These data will also inform the practicalities of the transportation of organisms to other locations where humans might explore, such as asteroids and Mars, the expected damage to these systems, and whether they might be modified by genetic manipulation/synthetic biology to improve their use.

4 BioMoon payload description

Bearing in mind the hypotheses described above and the practical needs for their realisation, it was then possible to conceive of a total payload architecture that would address these questions and allow for integrated studies using common means of analysis. Figure 2 shows a conceptual illustration of the BioMoon basic concept which shows the major elements. They include the passive (dormant cells and biomolecules) experimental suite (which includes the dosimetry package) and the active biology suite (actively growing biological systems). The diagram shows the addition of the analytical suite (including genetic and metabolic ('-omics') instrumentation payload) and a regolith collection arm.

The proposed payload suite for the BioMoon project combines several payloads to run as one integrated mission that would offer the opportunity to perform multiple scientific experiments in parallel. A significant benefit of this approach

Fig. 2 BioMoon notional overview. **A.** BioMoon CDF study logo. **B.** Conceptual overview of main units conceived prior to CDF. **C.** Main elements of EL3 spacecraft showing payload location (see text for dimensions)

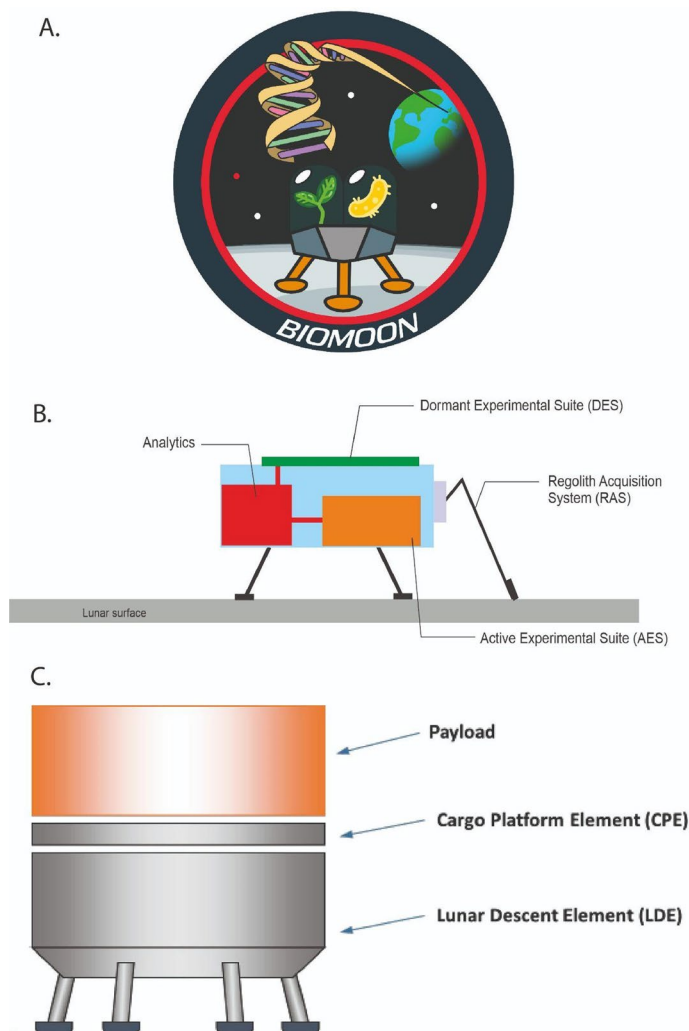

is that the life history of samples will be identical, removing environmental variation between different experiments as a factor when processing data.

The payload suites range in complexity, from designs based on hardware that has already been flown, and therefore has a high Technological Readiness Level (TRL5-9), such as the Dormant Experimental Suite (PES_DES), to less mature payloads, some of which require significant development at the time of writing, for example the complex trophic ecological experiments (Closed Ecosystem payload (AES_CECO)), which are lower (TRL 1–3) level.

Proposed payload suites comprise dormant and active experiments, with dormant and actively growing organisms in self-contained experimental units. There is also a suite dedicated entirely to dosimetry for environmental monitoring purposes (Dosimetry payload (PES_DOS)) and a unit for future biotechnological developments (Omics Instruments payload (BDS_OMICS)). In the latter case, certain assumptions have been made here about the state of technology, but because of the pace of biotechnology development, especially in sequencing technology and ‘-omics’, this unit can be considered as a placeholder to be populated by relevant biotechnology tests at the time of the mission. The nominal location of the different payloads is shown in Fig. 3.

In terms of the operation of the different payloads, it was considered that they would be powered from launch to end of life. Payload data would be stored from launch until beginning of landing and transmitted to the ground during the post-landing commissioning phase. We required that the payload data downlink and commanding frequency would be at least once every three hours during the experiment commissioning on the lunar surface to allow for intervention if necessary. Then downlink would be once every 24 h in nominal surface operations. Thermal interface control at defined temperature ranges would be ensured by the overall system, while internal science samples and instruments thermal control would be ensured by each payload unit.

4.1 Non-active experiments suite

These experiments include biomolecules and biological systems in a state of non-activity (e.g. desiccated) and the dosimetry package.

4.1.1 Dormant experimental suite (PES_DES)

4.1.1.1 Scientific objective To understand changes in the molecular structure/pigments and cell structure in the lunar environment.

Data from this payload will provide new insights on the rates and pathways of degradation that occur in biological molecules and whole systems in the exposed lunar radiation environment, and in conditions which can be compared, i.e., light (UV exposed) and dark (covered) samples with and without regolith. Results obtained will provide information for future life detection missions by advancing our knowledge of the longevity of biomolecules and whole organisms in the space radiation environment [33].

4.1.1.2 General description This payload consists of a set of biological experiments on dormant organisms that include dried bacteria, algae, fungi and other cells, as well as cellular components and organic molecules of importance for fundamental science, astrobiology and planetary protection. Based on the successful ESA EXPOSE/OREO-CUBE [34] and other payloads with high TRL level 9 (Fig. 4), the lunar platform has organisms selected to cover the range of model organisms and their complexity. Organisms are also selected to cover the phylogenetic diversity and internal cell complexity associated with biological systems that might be used in human missions to the lunar surface (i.e., microorganisms, plants, aquatic organisms in life support systems). The experiment is implemented by using a surface deck to allow for exposure to full lunar radiation conditions (including UV radiation).

Many dormant biological organisms will be identical to those grown in the active experimental systems, allowing for an ability to characterise biological responses to the same lunar surface environmental factors in both dormant (non-repairing) and active (repairing) mode.

This payload shall nominally have ~50 model organisms leading to 150 samples in total (triplicate samples). The total mass (per sample container) will be ~5–10 g. The volume (per sample container) is estimated as Ø15 mm × 10 mm.

4.1.1.3 Sample selection Types of samples include organics (amino acids, fatty acids, nucleic acids, etc.), biomolecules (DNA, lipids, carbohydrates, proteins, extracted pigments from whole organisms such as photosynthetic pigments, etc.),

Fig. 3 CDF diagram showing locations of the major experimental payloads. **A.** Overall BioMoon spacecraft. **B.** Location of active bioscience experiments within lander. **C.** Location of external (including passive) experiments. AES_ABS, Active Biological Systems payload; AES_CECO, Closed Ecosystem payload; AES_LUHA, Lunar Hatch payload; AES_URI, Urine to O₂ payload; APM, Antenna Pointing Mechanism HGA, High-Gain Antenna; LDE, landing, descent and entry module; LGA, Low-Gain Antenna; PES_DES, Dormant Experimental Suite; PES_DOS, Dosimetry payload

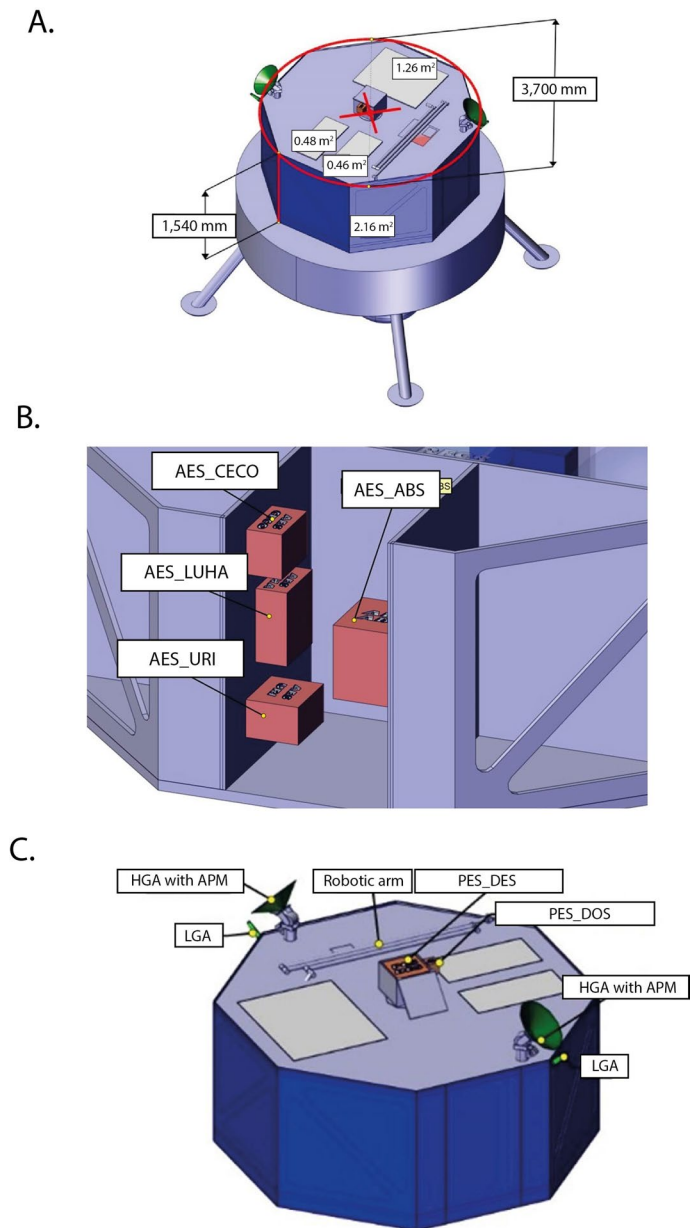

Fig. 4 The Dormant Experimental Suite (PES_DES) is based on the successful ESA EXPOSE facility, shown here outside the International Space Station (ISS), and other passive exposure payloads. (Size: 65 × 46 cm², height 15 cm). The samples can be seen within circular enclosures covered by filters and/or protective transparent covers



and model organisms as thin films or bulk samples in small containers. The latter would be bacteria (including cyanobacteria), archaea, algae [35], fungi, plant materials, plant seeds, and animal cells/small organisms (e.g. tardigrades). Samples can contain different gases and/or liquids and could be mixed with lunar regolith.

4.1.1.4 Instruments/measurements These samples will be investigated using visible microscopy, Raman spectroscopy and Fourier Transform Infrared (FTIR) spectroscopy. The radiation environment of the dormant organism experimental suite will be monitored in the UV and ionising regions by both active and passive dosimetry fulfilled by the PES_DOS payload (see text below). It is expected that the rack containing the organisms will be interrogated with spectroscopy from below (in the case of organic films) or above the samples (in the case of molecules and/or organisms on rock surfaces). This would be achieved with a sliding grid-like configuration with a sensor head that can interrogate each sample sequentially.

4.1.2 Dosimetry payload (PES_DOS)

4.1.2.1 Scientific objective To quantify the radiation environment on the lunar surface, including high atomic number and energy (HZE) cosmic particle radiation.

The dosimeter package also includes dummy biological materials to study shielding effects on radiation penetration, including water/fluid shielding experiments to quantify the high energy charged particle and neutron fluxes on the lunar surface that would be experienced by biological material.

4.1.2.2 General description One of the critical environmental factors on the Moon that represents the greatest threat to the successful operation of biological systems, including humans, is the significantly more hostile and dynamic radiation environment on the lunar surface than LEO. This payload includes active and passive dosimetry capable of characterising the radiation field (outside and inside the lander).

4.1.2.3 Instruments/measurements Several subunits of the dosimetry package were considered: 1) UV and Visible spectrometers on the surface of the lander, 2) Low and high energy neutron detectors inside the lander similar to the Lunar Lander Neutron and Dosimetry (LND) instrument [36], measuring radiation from above and radiation coming up from lunar surface (this was envisaged to require two sets of dosimeters), and 3) Smaller active dosimeters such as the M-42 developed by DLR [37] placed in: a) the passive samples on the surface of the lander, b) the active biological units, and c) the complex trophic levels experiments. The team envisaged smaller dosimeters (5 of them) behind various materials, including water/polymer similar to cellular material, to study the effective biological radiation flux. These dosimeters would be placed within the dormant samples on the lander's surface.

The dosimetry package draws its heritage from several prior packages including: European Active Dosimeter, ISS RAD, RAD Dosimetry on the NASA Curiosity Mars rover, LND Dosimetry, M-42 from DLR, UV Dosimetry, and BioStack from DLR.

4.2 Active experiments suite: basic biological models

The active experiments suite allows for the study of actively growing biological systems within the lunar environment.

4.2.1 Active biological systems payload (AES_ABS)

4.2.1.1 Scientific objective To study the growth and physiological function of a diversity of model systems under lunar conditions and to obtain critical knowledge pertinent to supporting extended human presence on the Moon

The system would investigate the behaviour of whole organisms, investigating the effects of gravity, radiation and other factors on the growth characteristics of the model organisms. The payload is designed to study a wide diversity of model organisms using an identical payload design.

4.2.1.2 General description One of the major goals of BioMoon is to investigate active biological systems in lunar conditions to understand how the lunar surface conditions, including partial gravity, radiation, and regolith interactions influence life, to obtain knowledge pertinent to supporting extended human presence on the Moon. This unit will contain many enclosed wells (~200 µL) containing biological systems that will be activated (by fluid injection) upon arrival and

commissioning of the BioMoon mission. Samples will grow and during the mission, key parameters will be measured and compared to a parallel ground-based experiment.

4.2.1.3 Sample selection The biological models in this unit would include a variety of targets. The following were considered: (1) *Cyanobacteria*. Cyanobacteria are the earliest branching oxygenic phototrophs and offer insights into the response of prokaryotes to the space environment. As producers of oxygen and organisms that can grow in rock environments, they have an application to life support systems, ISRU and bio-manufacturing [38, 39], (2) *Algae*. They are phototrophic eukaryotes that provide a comparison to the prokaryotic cyanobacteria, allowing us to understand how the different domains of life behave in the space environment (e.g., www.ccap.ac.uk). Algae can be used to produce oxygen, fuels, drugs and many other products of direct benefit to life support and a long-term human presence in space [40], (3) *A range of non-photosynthetic prokaryotes (bacteria, archaea), yeast and fungi*. Non-phototrophic bacteria (bacteria that either use minerals or organics as a source of energy) are prokaryotes. Fungi are eukaryotes that use organics for their energy.

These organism types are representative of many microorganisms that will be used in life support systems, that can cause disease, that will form biofilms and foul pipes and infrastructure, that will grow in soils, etc. This growth chamber will allow for comparison between the phototrophic prokaryotes (cyanobacteria) and phototrophic eukaryotes (algae) to determine the best organisms for phototrophic applications (for example, oxygen production). Samples will also include models to investigate antimicrobial resistance and drug production (drug discovery) and selected radiation sensitive strains to measure radiation end point effects on organisms (for example, final biomass), (4) *Plants*. The culture chambers can contain small seeds that can be activated with fluid and their germination growth in early stages monitored. Root development can be monitored. This allows us to study a range of plant models and their capacity to be activated on the Moon, (5) *Animal models*. The culture chamber can be used to study the growth of insect and other desiccation-preservable animal models on the Moon, for example the hatching and morphological attributes of mites and other organisms. Knowledge on the effects of lunar conditions on these organisms is necessary in the context of space agriculture, food production and the establishment of permanent bases on the surface of the Moon or Mars [41]. These samples would include mammalian model systems and human cells or organoids with applicability to animal and human health on the Moon, as well as providing data on the effects of radiation on human cells and tissue lines with terrestrial application.

4.2.1.4 Instrument/measurements Microfluidics will be used to investigate a diversity of parameters in the active growth wells using sensors. The measurements to be taken include: (1) growth (turbidity), (2) O₂ production or consumption, (3) CO₂ uptake or production, (4) pH, (5) conductivity, (6) photosynthetic activity (PAM). Suitable sensors to achieve these analyses in small sample volumes would need to be chosen from existing technology or developed.

The team envisaged a unit that would take much of its heritage from the BAMMSat concept (Bioscience, Astrobiology, Medicine and Material science on CubeSat) [42]. Samples would be integrated into a carousel-like sample chamber (Fig. 5). The carousel can be rotated to allow interrogation of each sample by optical and microscopy sensors, but also by microfluidics devices which can retrieve fluid from each sample chamber for analysis of key gas and fluid materials as listed above.

4.2.2 Bioreactors payload (AES_BIO)

4.2.2.1 Scientific objective To investigate bioprocessing and large scale biomanufacturing on the Moon

The crucial difference between this experiment and the Active Biological Systems payload (AES_ABS) is investigating how scaling up the volume of liquid affects the scientific results obtained and its implications for large volume applications such as bioprocessing on the Moon. Furthermore, local fresh regolith will be incorporated into three of the bioreactors to investigate the in-situ resource use of regolith material and the effects of regolith on biological systems.

4.2.2.2 General description In addition to a large number of small-scale samples, which allow investigations on a wide range of biological processes and model organisms, it is also necessary to scale up to larger volumes to test bioprocessing and recycling systems on the Moon at more realistic scales. This package will use 12 bioreactors (each with a volume of ~0.5 L) to grow chosen model organisms and it may build on the ESA ArtEMIS type design [43] (Fig. 6). The bioreactors will be activated once the lander is commissioned to measure key growth parameters.

4.2.2.3 Sample selection The species have yet to be determined but proposed model organisms include algae and heterotrophic bacteria such as *Sphingomonas* capable of biomining type activity [44]. Some of the organisms chosen will be identical to those used in the Active Biological Systems payload (AES_ABS), such as phototrophs, to allow for comparisons of the effects of scale on biological function.

4.2.2.4 Instrument/measurements As with the Active Biological Systems payload (AES_ABS), parameters to be measured include: growth (e.g., turbidity), metabolic and pigment state by imaging, and gas use and production (e.g., O₂ and CO₂ production and use). Temperature, relative humidity, pH, electrical conductivity, redox potential, and fluid ion content will be measured using ion selective electrodes (Fig. 7).

In this experiment, we envisaged integration of analytical capabilities with the Active Biological Systems payload (AES_ABS). Fluids removed from the bioreactors would be examined by the same instruments calibrated to the same standards, allowing for direct comparisons of growth rates, and biological changes between small scale and large-scale experiments.

4.3 Active experiments suite: basic trophic models

These active experiment suites advance beyond the study of fundamental biological models to investigating trophic level interactions.

4.3.1 Urine to O₂ payload (AES_URI)

4.3.1.1 Scientific objective The scientific objective is to examine microbe-plant interactions in a simplified biological life support system experiment

The system will study the efficacy of the microbial processing of urine and the transfer of the nutrients to a plant module. In essence, this experiment can be considered as part of the Bioreactors payload (AES_BIO), but with two bioreactors connected to each other. In one bioreactor, urine is introduced into a regolith/microbial community for processing. After 14 days, the fluid from this compartment is pumped into a second reactor in which plant germination and growth is observed.

Fig. 5 Conceptual illustration of the Active Biological Systems payload (AES_ABS) and the carousel-like configuration based on the BAMMSat concept

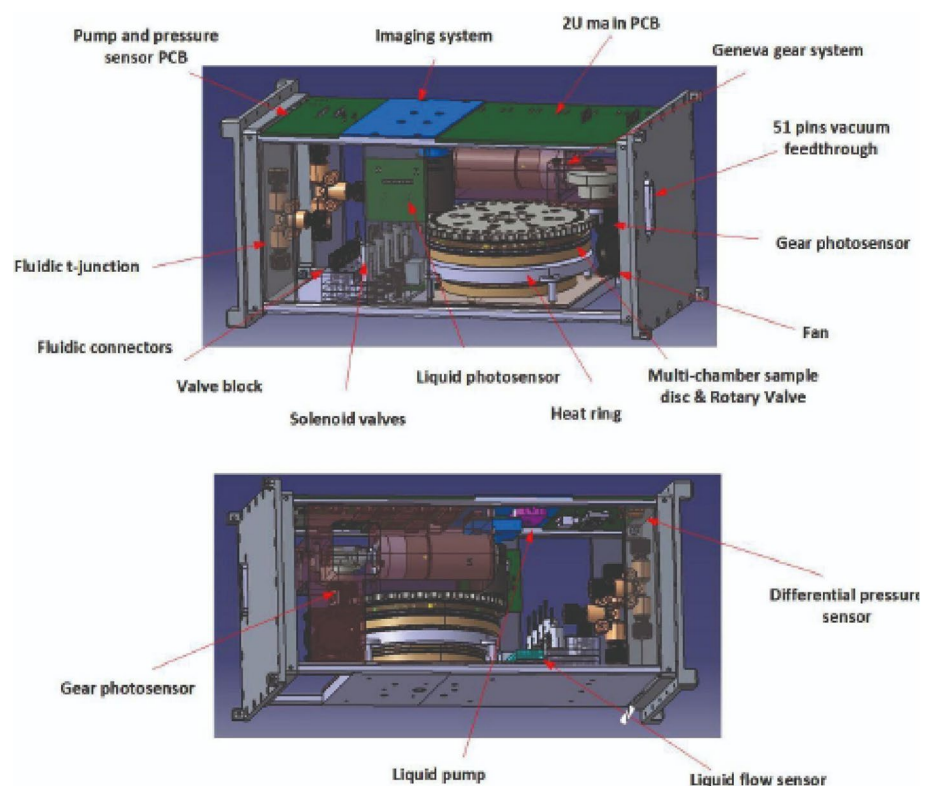

Fig. 6 The ESA ArtEMIS bioreactor design, which is considered a baseline design for the bioreactors described for the Bioreactors payload (AES_BIO) and the Active Experiments Suite—Basic trophic models. LED, light-emitting diode; OMU cuvette (monitoring unit for cell density and photosynthesis) [43]

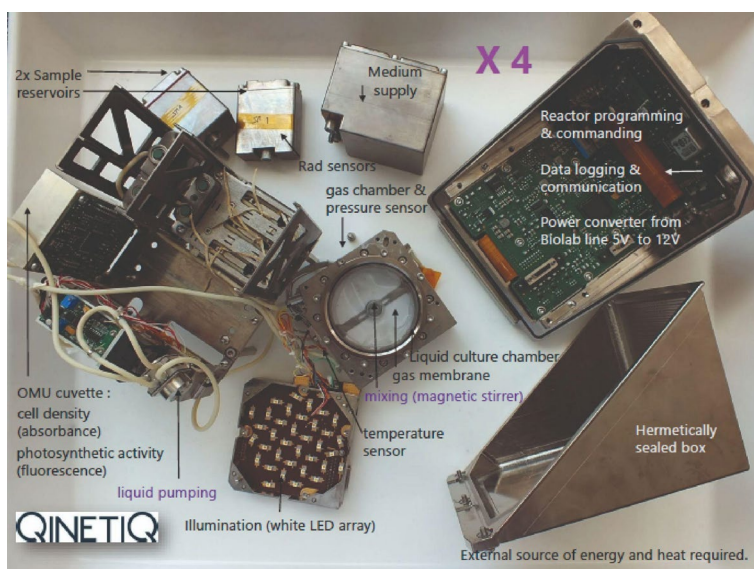
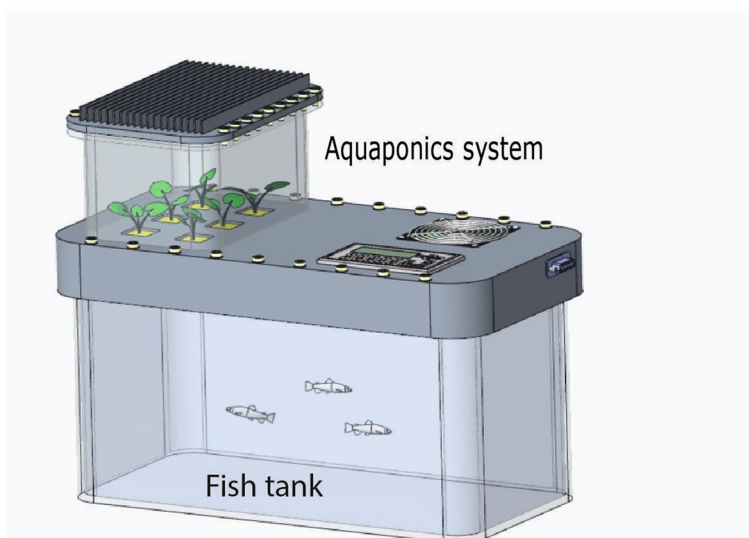

Fig. 7 A basic conceptual design for the Closed Ecosystem payload (AES_CECO)



4.3.1.2 General Description This payload is an augmentation of the experimental unit: Bioreactors payload (AES_BIO). Its purpose is to demonstrate the feasibility of a simple trophic chain of relevance to biological life support systems using urine as the main nutrient source for plants after processing by a microbial community.

4.3.1.3 Sample selection The experiment comprises two bioreactor units: one with microorganisms and one with plants, the latter being fed with urine processed by the microbial community. The experiment is based on the Bioreactors payload (AES_BIO) described above using the same analytical capabilities.

4.3.1.4 Instrument/measurements As with Bioreactors payload (AES_BIO), fluid will be examined to determine growth (e.g., turbidity), metabolic and pigment state by imaging, and gas use will be examined (e.g., O_2 production, CO_2 use). Temperature, relative humidity, pH, electrical conductivity, redox potential, and fluid ion content will be measured using ion selective electrodes.

4.3.2 Microbe-Assisted plant growth payload (AES_MAPG)

4.3.2.1 Scientific objective To test whether a component of a life support system using plants growing in lunar regolith can be implemented

The regolith will be added to a bioreactor unit containing microorganisms that are desiccated. These organisms are activated by simultaneous injection of fluid. The payload tests the scientific hypothesis that microorganisms can be used to break down regolith into accessible nutrients for plants.

4.3.2.2 General description The experiment tests the feasibility of growing plants in fresh lunar regolith with the assistance of microbial communities (which are used to leach mineral nutrients (e.g. Fe, Ca, Mg, K, Na and other cations), avoid the accumulation of metals to toxic concentrations, and provide nitrogen fixation so that nitrogen is available to the plants). Local fresh regolith will be added to a bioreactor unit containing desiccated microorganisms and then liquid (medium) will be added to activate the experiment on the lunar surface.

4.3.2.3 Sample selection Basic trophic chain with microorganisms and plants growing in local regolith, fed by nutrients extracted from the regolith by the microorganisms (with N and C pre-added to the unit).

4.3.2.4 Instrument/measurements The experiment will investigate O₂ production. Photography will be used to study plant growth. 16S metagenomics (or DNA microarrays) will be used to assess microbial population dynamics.

4.4 Active experiments suite: complex trophic models

This active experiment suite advances beyond the study of basic trophic level interactions to investigating the effects of the lunar environment on more complex trophic interactions, including animal components [45]. These experiments use bespoke experimental containment packages different to the standardised bioreactor experiments described in the previous experiments.

4.4.1 Lunar hatch payload (AES_LUHA)

4.4.1.1 Scientific objective To investigate aquaculture fish behaviour and growth to better understand fish as food sources for farming on the lunar surface

The experiment assesses the embryo and post-hatching fish development in the lunar environment. A hatching rate is evaluated using a camera. The mission results will identify technological challenges for the next steps and demonstrate closed loop system operation and functionality on the Moon.

4.4.1.2 General description This payload is an experiment to study fish farming on the Moon as a means of protein and lipid production for life support systems. This growth chamber investigates an aquatic life support system, recognising that aquatic biological systems are likely to form an integral part of life support systems on the Moon [45]. The experiment uses a simple unit to grow aquaculture fish from the embryos to a larval state examining their growth and development and associated biological parameters. Heritage of the experimental package comes from C.E.B.A.S (Closed Equilibrated Biological Aquatic System) [46], ArtEMIS-BioReactor and other payloads. The experimental package is at low TRL (1–3) and would be a good candidate for development.

4.4.1.3 Sample selection Aquaculture fish eggs will be fertilised on Earth and the hatching will occur on the Moon. A simple trophic chain will be installed at the beginning of the mission, with aquaculture fish larvae fed with cryoplankton and/or inert micro pellets. Fish species candidates and cryoplankton/pellet quantities will depend on the space dedicated to the Lunar Hatch experiment.

4.4.1.4 Instrument/measurements The following parameters will be measured: water temperature, O₂ consumption, CO₂ production, NH₄ concentration and NO₂ concentration, fluid hormone in the water to determine the potential stress of the organisms. Video and photography will be used to investigate larval growth, swimming and feeding behaviour. Radiation measurements will be obtained with the Dosimetry payload (PES_DOS).

4.4.2 Closed ecosystem payload (AES_CECO)

4.4.2.1 Scientific objective To understand living organism behaviour and growth with respect to their use as food source for farming on the lunar surface

This experiment will identify the technological challenges and demonstrate closed loop system operation and functionality on the Moon.

4.4.2.2 General description This payload is a mixed package containing microbes, plants and fish to investigate organismal interactions under lunar conditions. It is the most complex of the BioMoon payloads and is focused on testing a miniature life support system for lunar deployment. The data gathered will allow us to evaluate which environmental stresses on the Moon dominate the response for different biological model organisms that represent components of a human presence on the Moon (prokaryotes, single and multi-celled eukaryotes including human cell model organisms). For example, radiation and gravity have differential effects and by examining the range of biological systems we propose, we will be able to understand how different factors are influenced by cell type or phylogenetic affiliation or cellular complexity. The experimental package is at TRL 1–3 and would be a good candidate for development.

4.4.2.3 Sample selection Complex closed trophic system (~2–3 L) with fish, snails, shells and algae, coupled with an aquaponics chamber for vegetables. The exact species are yet to be determined.

4.4.2.4 Instrument/measurements The following parameters will be measured: water temperature, O₂, CO₂. Video and photography will be used to investigate growth. Radiation measurements will be obtained with the Dosimetry payload (PES_DOS).

4.5 Biotechnology demonstrator suite: omics instruments payload (BDS_OMICS)

This experimental suite is a technology demonstration and testing suite designed to investigate the effectiveness of a range of biotechnology analytical methods on the Moon. The technology is rapidly developing and will certainly be out of date by the time such a mission is realised in practice. Thus, what is described here provides an example of the concept. The suite not only tests lunar biotechnology, but also is used in DNA sequencing and molecular analysis of samples derived from the active experiments described earlier.

4.5.1 Scientific objective

The biotechnology package will be an experiment in itself, containing its own samples for processing. Specific areas we envisaged testing include: (1) Miniaturisation and automation of DNA/RNA sequencing, protein and metabolite analysis in space, (2) Miniaturisation and automation of chemical analysis of solutions and ion concentration monitoring in space, (3) Sensor applications in space to measure gases, ions, physical conditions of relevance to medical sensors and testing etc., (4) Miniaturisation of spectroscopic methods for studying biological systems including microscopy, Raman, FTIR, and (5) data analysis pipelines for biotechnology.

4.5.2 General description

Key to future operations on the Moon is the end-to-end automated analysis of biological samples and the use of biotechnology on the Moon, including -omics analysis, sequencing technologies, novel sensing and monitoring equipment (imaging, spectroscopy, ion sensing, etc.). These technologies are rapidly developing, and their automation and improvement for space missions are an ongoing process. These technologies have been developed for use on the ISS, but applying them on the lunar surface represents a new level of challenge that this mission will address.

4.5.3 Samples and instrument/measurements

The unit will focus on the end-to-end analysis of biological samples, including DNA, RNA, lipid and protein samples, to investigate the accuracy, efficiency and effectiveness of the methods on the lunar surface. The core technology will be based on

NanoPore™ sequencing technology and derivations of this capability. DNA, RNA, protein and lipid samples would be used in the package. Samples will also be provided from the active biological payloads as well as pure control samples within the experimental unit itself.

4.6 Other payload units

In addition to the science payloads, the BioMoon mission will also have a unit to collect regolith material for use in active biological experiments.

4.6.1 Regolith processing box (RegBox)

4.6.1.1 General description and operation This unit will collect an estimated regolith mass of ~ 120 g, including a 100% margin (6×10 g samples; three samples are required for each AES_BIO and AES_MAPG package). Fresh regolith would be delivered to a dedicated Regolith Processing Unit for analysis, conditioning and final dispatch to Bioreactors (AES_BIO) and Microbe-Assisted Plant Growth (AES_MAPG) payloads. Typical heritage includes the ESA Rosalind Franklin ExoMars Rover sample preparation and distribution system.

Regolith acquisition, conditioning and distribution are part of payload commissioning during post-landing operations. Conditioning includes graining the collected sample to suitable particle size while keeping samples within suitable thermal conditions.

5 Payload budgets summary

Although the level of definition of the payload suite is preliminary, the relevant heritage identified for each one of the payloads allowed the compilation of a comprehensive list of nominal resources needs for this feasibility study. These are the summary data gathered during the course of the design process, and they are shown in Table 1.

6 Some fundamental mission requirements

Given that this mission involves the use of biological samples, several requirements were identified to ensure the integrity of the samples. In the pre-mission phase, the following pre-flight and upload requirements were envisaged:

- Temperature control of samples (above 5 °C and below 35 °C) to be used for active biological analysis to minimise loss of viability.
- Late access (24 h before launch) may be required.
- Low humidity (~ 10- 20%) of desiccated samples must be maintained.

On the lunar surface:

- Collection of regolith and insertion into active and dormant modules in mission.
- Temperature control of pressurized (~ 1 bar) active chambers (20–25 °C).
- Humidity control in chambers (~ 10–100% RH).
- Artificial light for photosynthetic growth chambers (to 0–1000 $\mu\text{moles}/\text{m}^2/\text{s}$).
- Active analysis of samples, both dormant and actively growing biological systems.
- Capacity for physiological and genetic analysis (-omics).
- Data transmission from the lander to scientists on Earth.

7 The failure modes of BioMoon

Biological systems can be complex and unpredictable. For this reason, BioMoon was designed by the team to incorporate several ‘failure levels’ ensuring that even if the mission was minimally successful, important new data would be returned, allowing us to achieve significant scientific outcomes. These levels could also be considered to represent de-scoping options for the mission (for example, if local regolith acquisition was not possible, level 3 could be eliminated from this mission iteration).

This multi-layered approach consists of the following levels of mission success:

Level 1 (Minimal mission concept or minimum mission success). Dormant molecular and cell exposure to the lunar environment on the surface of the lander with spectroscopic analysis/imaging of samples as the minimal lander operation is achieved. This would provide important information on the fate of biological systems in the lunar environment of importance to subject areas directly related to a future human presence on the Moon. They include: astrobiology, planetary protection, human health and life sciences, specifically yielding new information on the effects of lunar surface radiation and hypogravity on biological systems.

Level 2 Successful operation of active culture chambers using their incorporated sensor suites. This minimal active chamber operation would provide us with important new knowledge on growth, gas production and use, and effects of gravity and lunar radiation on the growth and behaviour of active biological systems on the Moon. The built-in sensor suites within each culture chamber are selected according to the question: ‘If these were the only sensors available, could you still get important scientific results?’ For example, the aquatic culture chamber has within it sensors to measure nitrite/nitrate so that a set of sufficiently comprehensive data for publication can be achieved by the operation of the culture chamber alone.

Level 3 Behaviour of biological systems in contact with lunar dust/regolith is successfully investigated. Successful introduction of regolith and operation of active chambers would provide us with information on the role of dust/regolith in biological toxicity and the capacity of biological systems to process lunar materials for ISRU/life support systems.

Level 4 In-depth investigation of molecular responses of life to the lunar environment is achieved. The highest level of success would involve successful operation of the reactors, introduction of regolith to carry out sequencing, -omics, advanced imaging and chemical analysis of samples from the different growth chambers.

BioMoon aims for success at all four levels, but the mission was designed in a modular fashion so that, for example, failure of the biotechnology (-omics) facility would not compromise addressing our scientific hypotheses, but merely reduce the quality and quantity of data obtained that can be used to address the hypothesis.

Table 1 Payload budgets summary for BioMoon providing mass, volume, power and data generation values

Payload budgets summary						
Payload unit	Mass [kg]	Volume [mm ³]	Power [W]	Data generation [MB/day]		
				Transfer	Commis- sioning	Surface Ops
PES_DES	13.2	280 × 350 × 350	5	2	50	800
PES_DOS	24	200 × 200 × 200	5	50	50	50
AES_ABS	60	350 × 350 × 350	20	5	30	1200
AES_BIO	60	520 × 280 × 320	42	5	30	200
AES_URI	12	180 × 250 × 300	10	5	30	350
AES_MAPG	12	180 × 250 × 300	10	5	30	350
AES_LUHA	24	350 × 150 × 300	10	500	500	500
AES_CECO	66	215 × 300 × 170	10	10	50	1000
BDS_OMICS	24	300 × 300 × 300	10	2	50	1000
RegBox	18	500 × 500 × 500	10	0	50	0
Total	313.2		122	584	870	5450

8 Summary of the systems and engineering architecture description for BioMoon

This paper is primarily focused on the science elements of the mission. However, here we summarise the systems and engineering considerations relevant to carrying out the science to give some idea of how the scientific requirements impinge on the overall mission architecture and design. More in depth analysis of these systems, their budgets, trade-offs and risk scenarios can be found in the complete CDF engineering description of BioMoon as described by Grenouilleau et al. [47].

8.1 General BioMoon systems and configuration

The BioMoon concept was designed under the constraint that the mission was able to deliver 1,800 kg to the lunar surface (including the payload cargo segment) and that the maximum diameter of the cargo module would be 4.57 m. It should operate for one lunar day (14 Earth days) and one lunar night (14 days), thus 28 days in total.

The landing, descent and entry module (LDE) would not provide power to the payload during the mission (see below for power description) and no communication with the payload would be available during landing. The payload would be fully independent from the LDE. The LDE would allow the craft to land within a radius of 250 m centred in the target landing site location.

The target landing site would be near the south pole with low Sun elevation during the lunar day near to a planned human base camp. The baseline was taken to be a landing near Shackleton crater (89.7°S). The daylight hours vary from periods of complete darkness within some craters to ~90% illumination on high points. For the sake of a baseline design, this mission was assumed to be exposed to sunlight for 50% of the time (i.e., 354 h of sun and 354 h of darkness).

We note that the experiments described here are not dependent on a lunar location and could be implemented anywhere on the Moon (or other planetary bodies for that matter). The location was chosen on the basis that Argonaut was envisaged as part of the Artemis lunar architecture which calls for the establishment of a human presence at the lunar south polar region.

In total, the mission experimental payload consists of nine experimental units (discussed above) with a total mass of 331.20 kg within a total spacecraft mass of 1508.50 kg (with power (373.10 kg) and structures (317.4 kg) constituting the two other largest mass-consuming elements).

8.2 Data handling and telecommunications

The location of the lander was assumed to provide a situation where Earth was visible between 30% (worst case) and 80% (best case) of the time.

Given the large data volumes from the science experiments, communications were designed with this requirement in mind. During the post-landing operations phase, the experiments are being commissioned. Given the critical time this represents for experiment testing and verification, then it was envisaged that communications with the ground station would be required every three hours during this 1–4-day commissioning phase. During the Lunar Surface Operations phase, it was determined that a 1.5 h slot every 24 h would be sufficient to transmit all mission data via K-band at 50 Mbps. This data requirement was calculated across all experiments to be 95.7 Gb/day.

Onboard data storage requirements were considered to require storage of ~4 Tbits of data, which can be accomplished using existing mass memory boards. All data handling was considered achievable based on Advanced Data Handling Architecture (ADHA) and Control & Data Handling Systems (CDHS) developed by ESA.

To achieve communications with Earth, the craft would be equipped with two 550 mm steerable K-band (downlink) high gain antennae and two fixed S-band (uplink) antennae.

8.3 Mechanisms, automation and robotic handling of regolith

The BioMoon craft was envisaged to be able to collect at least 120 g of regolith to provide to the experiments. The regolith will be collected by a robotic arm from the surface environment around the lander (within a 3 m radius) which will dispense the material into a funnel from which regolith will be dispensed to the surface experiments. This operation is envisaged to be done only once, but if this retrieval fails, the arm should be capable of repeating the operation. The arm would have a camera allowing for analysis of the proposed material prior to excavation. The team considered the

problem of contamination of the regolith during landing and this a matter that needs further exploration. One option is to scrape the surface material away to seek fresher material beneath. The team noted that robotic arm technology is well developed and has been employed on missions such as the Viking and Phoenix Mars missions to successfully collect surface regolith samples.

One proposed configuration was an arm with three segments (of 2.2, 2.0, and 1.8 m, respectively) and a clam-shell grabber at the retrieval end, giving the arm a range of 0.6 to 4.0 m from its attachment position on the upper part of the lander (Fig. 8). Alternative architectures would place the arm at a lower height on the lander. The peak nominal power for this regolith arm collection would be 38W.

In addition to the robotic arm, regolith acquisition unit, it was also envisaged to have a tilt mechanism to allow orientation of the Passive Experimental Suite (PES_DES) and Dosimeters (PES_DOS) towards the Sun with a retractable cover to be removed once landing has occurred. The pointing mechanism allows the lander to land on a slope up to 15° but no more. The retractable cover provides protection for the samples during transit and landing, but also ensures that UV radiation exposure of the passive biological model organisms only occurs once experimental surface operations have been initiated.

8.4 Thermal and power requirements

During transit to the Moon, thermal control would be provided to the payload since many organisms and biological systems cannot tolerate freezing and must be maintained at appropriate temperatures for survival. Thermal control must be provided to the experiments during the full lunar day and night cycle envisioned for the mission. The spacecraft would be equipped with 1.2 m² of louvered/shuttered radiators with heat pipes for thermal control. The power to the thermal system allows the spacecraft to maintain temperatures within all payloads at between 5 and 35 °C. The lower temperature is set by the need to maintain organisms safely above the freezing temperature to ensure that small fluctuations do not risk freezing. The upper temperature limit is set by the highest growth temperature of organisms and the need to prevent high-temperature thermal stress.

The total experimental and spacecraft power budgets yielded a power requirement of ~446 W during transit, ~294 W during lunar day operations (and up to 409 W during communications), and 328 W during lunar night operations (and up to 443 W during communications). These power requirements consider power required for data handling, the Cargo Platform Element (CPE) part of the EL3 architecture, and thermal control. The total power requirement for the scientific instruments was considered to be nominally a mean of 122 W for the duration of the mission (28 days).

Power on the lunar surface would be provided by 17.4 m² of circumferential mounted solar panels with the possible requirement for a vertically deployed solar array of 6 m². The architecture of solar panels required to provide sufficient power during surface operations was considered one area open to further design work. It was assumed that the solar array would suffer 5% degradation during the mission. The preference for solar power was based on the lack of the practical possibility of using radioisotope thermoelectric generators (RTGs) at the time of mission design, but also that the radiation from such systems might affect biological systems deleteriously by imparting another background source of radiation (or at least complicating the interpretation of data). If the RTG nuclear battery package can be suitably shielded, so that additional radiation dose to the biological payload is minimal, then there is no barrier to using such systems.

To allow for thermal control during transit and other power requirements, the mission would also be equipped with a 1,600 Wh Li-ion battery and a 129.7 kWh Regenerative Field Cell (RFC).

9 Conclusion

If humans are to venture long-term onto the surface of the Moon, we must know much more about the response and adaptations of model organisms and biological systems to the lunar environment, especially the effects of lunar gravity, radiation environment, and regolith. Here we present a mission concept, BioMoon, for an integrated set of life sciences experiments for a robotic lunar lander. BioMoon investigates the effects of the lunar environment on systems from component biological molecules up to multi-trophic ecological systems. Taking a systems level approach and using the same analytical and data processing methods, BioMoon represents a fully integrated lunar biosciences mission concept producing valuable comparable data of biological systems under lunar conditions. Although conceived specifically within the framework of ESA's EL3/Argonaut lunar architecture concept, the mission provides a template for a generic

Fig. 8 Diagram showing nominal location of the robotic arm on the payload and its reach

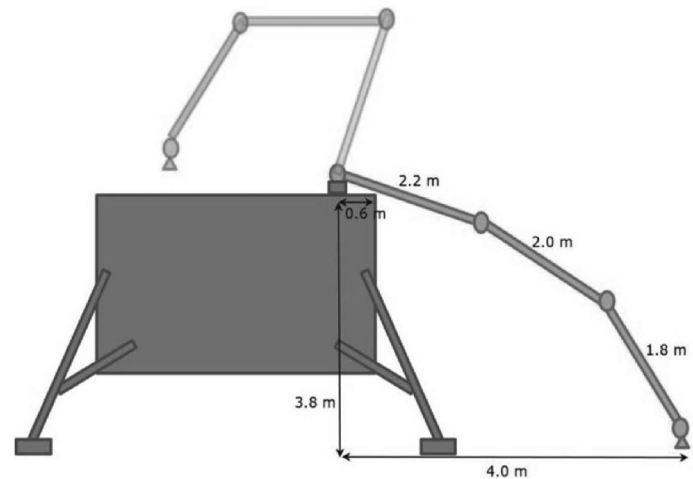

biosciences payload for the Moon and a set of experiments that could even be deployed from a human-tended lunar station. This mission concept may provide a useful framework for the design of integrated biosciences payloads for future bioscience payloads to other locations in the Solar System.

Acknowledgements CSC acknowledges support from the Science and Technology Facilities Council (Grants ST/V000586/1 and ST/Y001788/1). For the purpose of open access, the author has applied a Creative Commons Attribution (CC BY) licence to any Author Accepted Manuscript version arising from this submission.

Author contributions Charles S Cockell wrote the draft of the manuscript. David A. Green, Nicol Caplin, Jessica Grenouilleau, Francesca E. McDonald, Marco Calvaruso, Daniela Billi, David C. Cullen, Matthew P. Davey, Veronica De Micco, Andreas Elsaesser, Timothy Etheridge, Christine Gläßer, Christine E. Hellweg, Crina S. Ilea, Antoine Lecocq, Natalie Leys, Javier Martin-Torres, Miracle Nazarious, Claudia Pacelli, Cyrille Przybyla, Elke Rabbow, Kate Robson Brown, Alvaro Soria-Salinas, Nathaniel Szewczyk, Walter Tinganelli, Erin M Tranfield, Jean-Pierre de Vera, Cyprien Verseux contributed to the content, development and editing of the manuscript.

Data availability No datasets were generated or analysed during the current study.

Declarations

Competing interests The authors declare no competing interests.

Open Access This article is licensed under a Creative Commons Attribution 4.0 International License, which permits use, sharing, adaptation, distribution and reproduction in any medium or format, as long as you give appropriate credit to the original author(s) and the source, provide a link to the Creative Commons licence, and indicate if changes were made. The images or other third party material in this article are included in the article's Creative Commons licence, unless indicated otherwise in a credit line to the material. If material is not included in the article's Creative Commons licence and your intended use is not permitted by statutory regulation or exceeds the permitted use, you will need to obtain permission directly from the copyright holder. To view a copy of this licence, visit <http://creativecommons.org/licenses/by/4.0/>.

References

1. Lytvynenko T, Zaetz I, Voznyuk T, Kovalchuk M, Rogutskyy I, Mytrokhyn O, Lukashov D, Estrella-Liapis V, Borodinova T, Mashkovska S, Foing B. A rationally assembled microbial community for growing *Tagetes patula* L. in a lunar greenhouse. *Res Microbiol.* 2006;157:87–92.
2. Gronstal A, Cockell CS, Perino MA, Bittner T, Clacey E, Clark O, Ingold O, Alves de Oliveira C, Wathiong S. Lunar astrobiology: a review and suggested laboratory equipment. *Astrobiology.* 2007;7:767–82.
3. Carpenter JD, Angerer O, Durante M, Linnarson D, Pike WT. Life sciences investigations for ESA's first lunar lander. *Earth, Moon, Planets.* 2010;107:11–23.
4. Ferl RJ, Paul AL. Lunar plant biology—a review of the Apollo era. *Astrobiology.* 2010;10:261–74.
5. Crawford IA, Anand M, Cockell CS, Falcke H, Green DA, Jaumann R, Wieczorek MA. Back to the Moon: the scientific rationale for resuming lunar surface exploration. *Planetary Space Sci.* 2012;74:3–14.
6. Jawin ER, Valencia SN, Watkins RN, Crowell JM, Neal CR, Schmidt G. Lunar science for landed missions workshop findings report. *Earth Space Sci.* 2019;6:2–40.

7. Bijlani S, Stephens E, Singh NK, Venkateswaran K, Wang CC Advances in space microbiology. *Iscience*. 2021. <https://doi.org/10.1016/j.isci.2021.102395>.
8. Garshnek V. The lunar environment as a fractional-gravity biological laboratory. *Acta Astronaut*. 1994;33:211–5.
9. Scott JP, Kramer A, Petersen N, Green DA The role of long-term head-down bed rest in understanding inter-individual variation in response to the spaceflight environment: a perspective review. *Front Physiol*. 2021;12: 614619.
10. Allen LA, Kalani AH, Estante F, Rosengren AJ, Stodieck L, Klaus D, Zea L. Simulated Micro-, lunar, and Martian gravities on earth—effects on *Escherichia coli* growth, phenotype, and sensitivity to antibiotics. *Life*. 2022;12:1399.
11. Cain JR. Lunar dust: the hazard and astronaut exposure risks. *Earth, Moon, Planets*. 2010;107:107–25.
12. Ming DW, Henninger DL. Use of lunar regolith as a substrate for plant growth. *Adv Space Res*. 1994;14:435–43.
13. Horneck G. Life sciences on the Moon. *Adv Space Res*. 1996;18:95–101.
14. Reitz G, Berger T, Matthiä D. Radiation exposure in the moon environment. *Planetary Space Sci*. 2012;74:78–83.
15. Zhang S, Wimmer-Schweingruber RF, Yu J, Wang C, Fu Q, Zou Y, Sun Y, Wang C, Hou D, Böttcher SI, Burmeister S. First measurements of the radiation dose on the lunar surface. *Sci Adv*. 2020. <https://doi.org/10.1126/sciadv.aaz1334>.
16. Durante M, Cucinotta FA Heavy ion carcinogenesis and human space exploration. *Nat Rev Cancer*. 2008;8:465–72.
17. Deshevaya EA, Fialkina SV, Shubralova EV, Tsygankov OS, Khamidullina NM, Vasilyak LM, Pecherkin V, Shcherbakova VA, Nosovsky AM, Orlov OI. Survival of microorganisms during two-year exposure in outer space near the ISS. *Sci Rep*. 2024;14:334.
18. Walsh L, Hafner L, Straube U, Ulanowski A, Fogtman A, Durante M, Weerts G, Schneider U. A bespoke health risk assessment methodology for the radiation protection of astronauts. *Radiat Environ Biophys*. 2021;60:213–31.
19. Fong K. Moon landing: space medicine and the legacy of project Apollo. *The Lancet*. 2019;394:205–7.
20. Scott JP, Green D, Weerts G, Chevront SN. Effects of body size and countermeasure exercise on estimates of life support resources during all-female crewed exploration missions. *Sci Rep*. 2023;13:5950.
21. Scott JP, Weber T, Green DA optimization of exercise countermeasures for human space flight—lessons from terrestrial physiology and operational implementation. *Front Physiol*. 2020;10: 506853.
22. Kozyrovska NO, Lutvynenko TL, Korniihchuk OS, Kovalchuk MV, Voznyuk TM, Kononuchenko O, Zaetz I, Rogutskyy IS, Mytrokhyn OV, Mashkovska SP, Foing BH (2006) Growing pioneer plants for a lunar base. *Adv Space Res*. 2006;37:93–9.
23. Khan-Mayberry N The lunar environment: Determining the health effects of exposure to moon dusts.
24. Latch JN, Hamilton RF Jr, Holian A, James JT, Lam CW. Toxicity of lunar and martian dust simulants to alveolar macrophages isolated from human volunteers. *Inhalat Toxicol*. 2008;20:157–65.
25. Liu H, Yu CY, Manukovsky NS, Kovalev VS, Gurevich YL, Wang J. A conceptual configuration of the lunar base bioregenerative life support system including soil-like substrate for growing plants. *Adv Space Res*. 2008;4:1080–8.
26. Li M, Thompson KK, Nissen JC, Hendrix D, Hurowitz JA, Tsrirka SE. Lunar soil simulants alter macrophage survival and function. *J Appl Toxicol*. 2019;39:1413–23.
27. Paul A-L, Elardo SM, Ferl R. Plants grown in Apollo lunar regolith present stress-associated transcriptomes that inform prospects for lunar exploration. *Commun Biol*. 2022;5:382.
28. Sibille L, Carpenter P, Schlagheck R, French RA. Lunar regolith simulant materials: recommendations for standardization, production, and Usage. NASA Publication NASA/TP—2006–214605 (2006).
29. Green DA. How the UK can lead the terrestrial translation of biomedical advances arising from lunar exploration activities. *Earth Moon Planet*. 2010;107:127–46.
30. Cockell CS. Life Beyond 2: from prison to the moon. British Interplanetary Society, 2020.
31. Lowe D, Roy L, Tabocchini MA, Rühm W, Wakeford R, Woloschak GE, Laurier D. Radiation dose rate effects: what is new and what is needed? *Radiat Environ Biophys*. 2022;61:507–43.
32. Pajusalu M, Borlina CS, Seager S, Ono S, Bosak T. Open-source sensor for measuring oxygen partial pressures below 100 microbars. *PLoS ONE*. 2018. <https://doi.org/10.1371/journal.pone.0206678>.
33. Baqué M, Backhaus T, Meeßen J, Hanke F, Böttger U, Ramkissoon N, Olsson-Francis K, Baumgärtner M, Billi D, Cassaro A, de la Torre NR, Demets R, Edwards H, Ehrenfreund P, Elsaesser A, Foing B, Foucher F, Huwe B, Joshi J, Kozyrovska N, Lasch P, Lee N, Leuko S, Onofri S, Ott S, Pacelli C, Rabbow E, Rothschild L, Schulze-Makuch SL, Serrano P, Szewczyk U, Verseux C, Wagner D, Westall F, Zucconi L, de Vera J-PP. Biosignature stability in space enables their use for life detection on Mars. *Sci Advncs*. 2022;8:7412.
34. Rabbow E, Rettberg P, Barczyk S, Bohmeier M, Parpart A, Panitz C, Horneck G, von Heise-Rotenburg R, Hoppenbrouwers T, Willnecker R, Baglioni P. EXPOSE-E: an ESA astrobiology mission 15 years in space. *Astrobiology*. 2012;12:374–86.
35. Pardasani Y MRes Algal Biotechnology, Biology and Ecology. Supervisor: Davey MP. Algal dormancy and revivability in space. SAMS-UHI (2022). <https://pure.uhi.ac.uk/en/studentTheses/survival-potential-of-microalgae-for-long-term-space-missions>
36. Wimmer-Schweingruber RF, Yu J, Böttcher SI, Zhang S, Burmeister S, Lohf H, Guo J, Xu Z, Schuster B, Seimetz L, Freiherr von Forstner JL. The lunar lander neutron and dosimetry (LND) experiment on Chang'E 4. *Space Sci Rev*. 2020;216:1–40.
37. Berger T, Marsalek K, Aeckerlein J, Hauslage J, Matthiä D, Przybyla B, Rohde M, Wirtz M the German aerospace center M-42 radiation detector—a new development for applications in mixed radiation fields. *Rev Sci Instrum*. 2019;90: 125115.
38. Fahrion J, Mastroleo F, Dussap CG, Leys N. Use of photobioreactors in regenerative life support systems for human space exploration. *Front Microbiol*. 2021;12: 699525.
39. Verseux C, Heinicke C, Ramalho TP, Determann J, Duckhorn M, Smagin M, Avila M. A low-pressure, N₂/CO₂ atmosphere is suitable for cyanobacterium-based life-support systems on Mars. *Front Microbiol*. 2021;12: 611798.
40. Davey MP, Smith AG, Mehrshahi P, Harrison E, Mastroleo F, Leys N Microalgae biotechnology for space applications. In: Position Paper: Why Space? the opportunity for Health and Life Science Innovation. Ed. Kate Robson-Brown, Philip Carvil. UK Space Life and Biomedical Sciences Association (2021). <http://www.ukspacelabs.co.uk/news-events/association-news/357-why-space>
41. Kok R, Van Huis A. Insect food in space. *J Insects Food Feed*. 2021;7:1–4.
42. Shamsul A, Sinclair G, Bolliand A, Chabi A, Cooke M, Martinez de Bujo A, Zalasiewicz M, Etheridge T, Cullen D BAMMsat-on-BEXUS: A technology and operation demonstration of a bioCubeSat platform on a stratospheric balloon flight educational program. Poster SSC20-WP2–32 (2020). <https://digitalcommons.usu.edu/cgi/viewcontent.cgi?article=4702&context=smallsat>

43. Poughon L, Laroche C, Creuly C, Dussap CG, Paille C, Lasseur C, Monsieurs P, Heylen W, Coninx I, Mastroleo F, Leys N. *Limnospira indica* PCC8005 growth in photobioreactor: model and simulation of the ISS and ground experiments. *Life Sci Space Res.* 2020;25:53–65.
44. Cockell CS, Santomartino R, Finster K, Waajen AC, Eades LJ, Moeller R, Rettberg P, Fuchs FM, Van Houdt R, Leys N, Coninx I. Space station biomining experiment demonstrates rare earth element extraction in microgravity and Mars gravity. *Nat Commun.* 2020;11:1–11.
45. Przybyla C. Space aquaculture: prospects for raising aquatic vertebrates in a bioregenerative life-support system on a lunar base. *Front Astronomy Space Sci.* 2021;8: 699097.
46. Blum V, Stretzke E, Kreuzberg K. C.E.B.A.S.-AQUARACK project: the Mini-Module as tool in artificial ecosystem research. *Acta Astronaut.* 1994;33:167–77.
47. Genouilleau J and the BioMoon team BioMoon: Assessment of a lunar bioscience laboratory. European Space Agency (ESA) CDF-224(A), March 2022.

Publisher's Note Springer Nature remains neutral with regard to jurisdictional claims in published maps and institutional affiliations.